

# Complementos armario y mueble

## *Cabinet and furniture accessories*



|                     |                        |                       |                       |
|---------------------|------------------------|-----------------------|-----------------------|
| <b>Pantaloneros</b> | <i>Pants</i>           | <b>Amortiguadores</b> | <i>Shocks</i>         |
| <b>Zapateros</b>    | <i>Furniture shoes</i> | <b>Enganches</b>      | <i>Couplings</i>      |
| <b>Corbateros</b>   | <i>Tie racks</i>       | <b>Uniones</b>        | <i>Unions</i>         |
| <b>Percheros</b>    | <i>Hangers</i>         | <b>Portaestantes</b>  | <i>Shelf supports</i> |
| <b>Tubos</b>        | <i>Tubes</i>           | <b>Tuercas</b>        | <i>Nuts</i>           |
| <b>Casquillos</b>   | <i>Cap tubes</i>       | <b>Excéntricas</b>    | <i>Housings</i>       |
| <b>Soportes</b>     | <i>Supports</i>        | <b>Espigas</b>        | <i>Dowels</i>         |
| <b>Remates</b>      | <i>Ends</i>            | <b>Galletas</b>       | <i>Cookies</i>        |
| <b>Anillas</b>      | <i>Rings</i>           | <b>Tapones</b>        | <i>Caps</i>           |
| <b>Corchetes</b>    | <i>Brackets</i>        | <b>Lágrimas</b>       | <i>Tears</i>          |
| <b>Cierres</b>      | <i>Latches</i>         | <b>Topes</b>          | <i>Tops</i>           |
| <b>Expulsores</b>   | <i>Ejectors</i>        | <b>Deslizantes</b>    | <i>Glides</i>         |

# Complementos armario y mueble

## Cabinet and furniture accesories

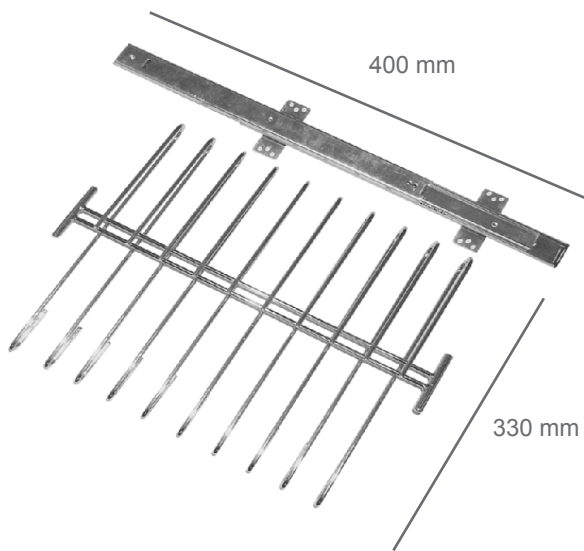

### PANTALONERO EXTRACCIÓN TOTAL

Total extraction pants

| código | acabado       | medida     | embalaje | precio  | 8431488 |
|--------|---------------|------------|----------|---------|---------|
| Nº     |               |            |          | €       |         |
| 94001  | chromo brillo | 8 perchas  | 5        | 23,0000 | 940014  |
| 94002  | chromo brillo | 10 perchas | 5        | 24,3500 | 940021  |

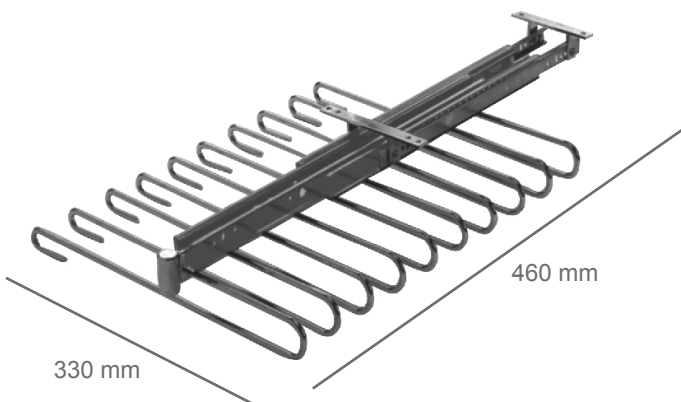

### PANTALONERO EXTRACCIÓN TOTAL

Total extraction pants





| código | acabado       | medida     | embalaje | precio  | 8431488 |
|--------|---------------|------------|----------|---------|---------|
| Nº     |               |            |          | €       |         |
| 94003  | chromo brillo | 11 perchas | 5        | 34,0500 | 940038  |

# Complementos armario y mueble

## Cabinet and furniture accesories

### PANTALONERO LATERAL



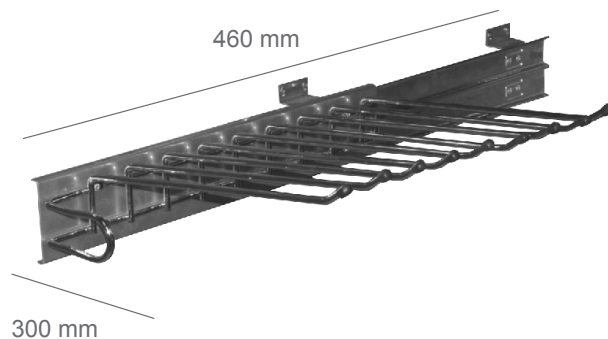

Side pants

| código | acabado   | medida  | embalaje  | precio  | 8431488   |
|--------|---|---|---|---------|---|
| Nº     |  |  |  | €       |  |
| 94004  | chromo brillo   | 9 perchas   | 3   | 35,6000 | 940045  |



### JGO. ZAPATERO PLÁSTICO

Set plastic furniture shoe

| código | acabado   | medida  | embalaje  | precio | 8431488   |
|--------|---|---|---|--------|---|
| Nº     |  |  |  | €      |  |
| 94025  | blanco  | 2 baldas  | 25  | 2,8000 | 940250  |
| 94026  | marrón  | 2 baldas  | 25  | 2,8000 | 940267  |

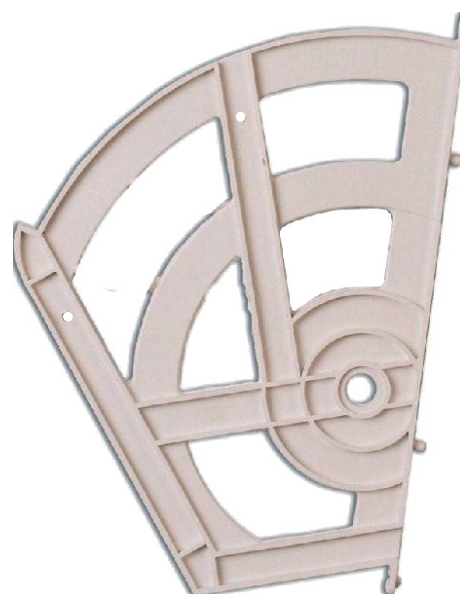

# Complementos armario y mueble

## Cabinet and furniture accesories

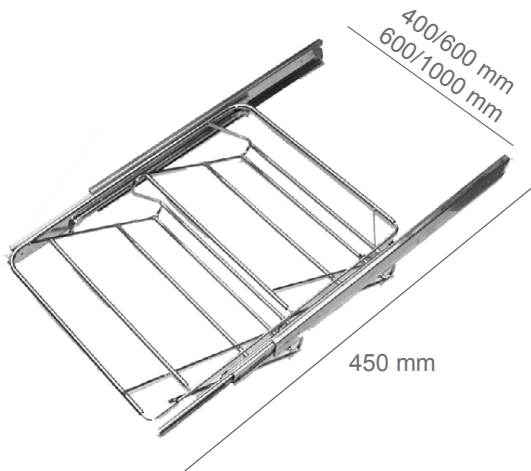

### ZAPATERO LATERAL EXTRACCIÓN TOTAL

Side shoe total extraction

| código | acabado       | medida              | embalaje | precio  | 8431488 |
|--------|---------------|---------------------|----------|---------|---------|
| Nº     |               |                     |          | €       |         |
| 94014  | chromo brillo | 400/600x120x450 mm  | 2        | 37,8500 | 940144  |
| 94015  | chromo brillo | 600/1000x120x450 mm | 2        | 47,2500 | 940151  |

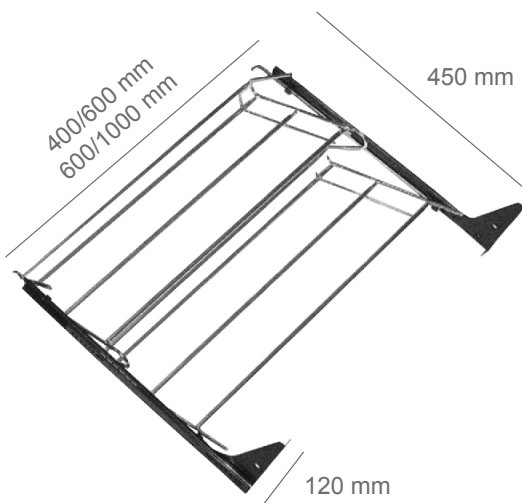

### ZAPATERO FRONTAL CAJÓN EXTRAIBLE

Front shoe removable drawer

| código | acabado       | medida              | embalaje | precio  | 8431488 |
|--------|---------------|---------------------|----------|---------|---------|
| Nº     |               |                     |          | €       |         |
| 94012  | chromo brillo | 400/600x120x450 mm  | 2        | 43,1000 | 940120  |
| 94013  | chromo brillo | 600/1000x120x450 mm | 2        | 52,2500 | 940137  |



# Complementos armario y mueble

## Cabinet and furniture accesories

### CORBATERO VARILLA

Rod tie rack



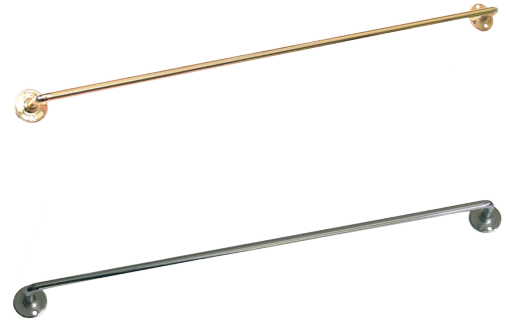

| código | acabado   | medida  | embalaje  | precio | 8431488   |
|--------|---|---|---|--------|---|
| Nº     |  |  |  | €      |  |
| 10079  | oro   | 250 mm  | 1/10  | 5,6700 | 100791  |
| 10080  | oro   | 300 mm  | 1/10  | 5,9300 | 100807  |
| 10081  | oro   | 350 mm  | 1/10  | 6,4900 | 100814  |
| 10082  | oro   | 400 mm  | 1/10  | 6,7500 | 100821  |
| 10083  | oro   | 450 mm  | 1/10  | 7,0200 | 100838  |
| 10084  | oro   | 500 mm  | 1/10  | 7,2800 | 100845  |
| 10792  | níquel  | 250 mm  | 1/10  | 5,1400 | 107929  |
| 10802  | níquel  | 300 mm  | 1/10  | 5,4000 | 108025  |
| 10812  | níquel  | 350 mm  | 1/10  | 5,9700 | 108124  |
| 10822  | níquel  | 400 mm  | 1/10  | 6,2300 | 108223  |
| 10832  | níquel  | 450 mm  | 1/10  | 6,4900 | 108322  |
| 10842  | níquel  | 500 mm  | 1/10  | 6,7500 | 108421  |

 Presentación en Blister - *Presentation in blister*



### SOPORTE PERCHAS EXTRAIBLE





Bracket hangers removable

| código | acabado   | medida  | embalaje  | precio | 8431488   |
|--------|---|---|---|--------|---|
| Nº     |  |  |  | €      |  |
| 94018  | cromo brillo  | 300 mm  | 1   | 3,0000 | 940182  |
| 94019  | cromo brillo  | 350 mm  | 1   | 3,3800 | 940199  |
| 94020  | cromo brillo  | 400 mm  | 1   | 3,7500 | 940205  |
| 94021  | cromo brillo  | 450 mm  | 1   | 4,1300 | 940212  |
| 94023  | cromo brillo  | 500 mm  | 1   | 4,5000 | 940236  |



### PERCHERO AUTOMÁTICO BASCULANTE

Auto hanger overhead

| código | acabado   | medida  | embalaje  | precio  | 8431488   |
|--------|---|---|---|---------|---|
| Nº     |  |  |  | €       |  |
| 94009  | aluminio  | 450/600 mm  | 1/3   | 59,7500 | 940090  |
| 94010  | aluminio  | 600/830 mm  | 1/3   | 59,7500 | 940106  |
| 94011  | aluminio  | 830/1200 mm   | 1/3   | 59,7500 | 940113  |



# Complementos armario y mueble

## Cabinet and furniture accesories

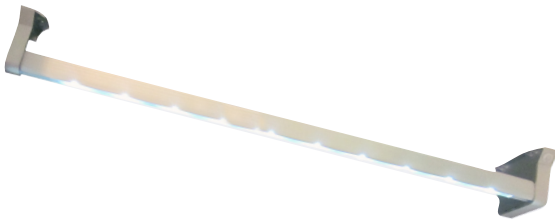

### TUBO ARMARIO C/LED

*Cabinet tube with led*

| código | acabado | medida        | embalaje | precio  | 8431488 |
|--------|---------|---------------|----------|---------|---------|
| Nº     |         |               |          | €       |         |
| 92001  | plata   | 1050 - 400 mm | 1        | 59,5000 | 920016  |

Activación mediante sensor de movimiento. Funcionamiento a pilas con fácil sustitución. Último tramo con corte para su perfecta adaptación. Incorpora una goma para evitar arañazos de las perchas.

Activation by motion sensor. Functioning to batteries with easy substitution. Last section with court for his perfect adjustment. It incorporates a rubber to avoid scratches of the hangers.

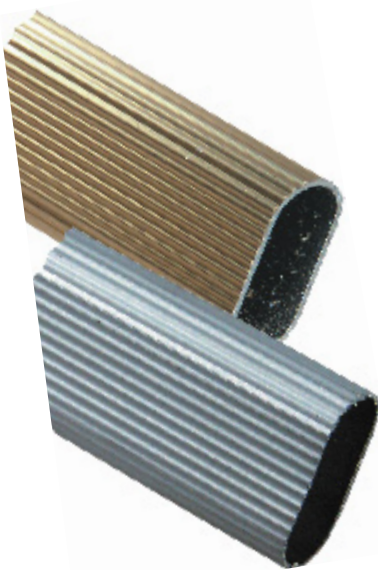
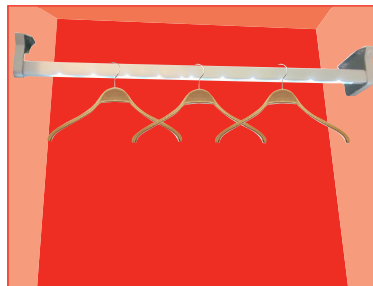

### TUBO ARMARIO OVALADO ALUMINIO

*Aluminium oval tube cabinet*

| código | acabado    | medida           | embalaje | precio  | 8431488 |
|--------|------------|------------------|----------|---------|---------|
| Nº     |            |                  |          | €       |         |
| 30400  | plata mate | 30x15 mm x 4 mts | 40       | 10,0000 | 304007  |
| 30401  | oro mate   | 30x15 mm x 4 mts | 40       | 10,9500 | 304014  |

Precio por tubo, espesor 1,2 mm - Price per tube, 1,2 mm thick

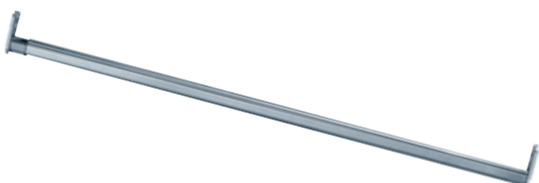

### TUBO ARMARIO EXTENSIBLE

*Tube extension cabinet*

| código | acabado       | medida      | embalaje | precio  | 8431488 |
|--------|---------------|-------------|----------|---------|---------|
| Nº     |               |             |          | €       |         |
| 30397  | chromo brillo | 400/600 mm  | 1/10     | 7,5600  | 303970  |
| 30398  | chromo brillo | 600/900 mm  | 1/10     | 9,0400  | 303987  |
| 30399  | chromo brillo | 900/1100 mm | 1/10     | 11,6400 | 303994  |

Presentación en blister. - Presentation in blister.

# Complementos armario y mueble

## Cabinet and furniture accesories

### TUBO ARMARIO REDONDO ACERO

Steel round tube cabinet

| código | acabado      | medida         | embalaje | precio  | 8431488 |
|--------|--------------|----------------|----------|---------|---------|
| Nº     |              |                |          | €       |         |
| 12150  | cromo brillo | ø12 mm x 1,5 m | 24       | 2,8320  | 121505  |
| 12200  | cromo brillo | ø12 mm x 2 m   | 24       | 3,7750  | 122007  |
| 12250  | cromo brillo | ø12 mm x 2,5 m | 24       | 4,7200  | 122502  |
| 12300  | cromo brillo | ø12 mm x 3 m   | 24       | 5,6630  | 123004  |
| 12400  | cromo brillo | ø12 mm x 4 m   | 24       | 7,5500  | 124001  |
| 12401  | blanco       | ø12 mm x 4 m   | 22       | 8,1000  | 124018  |
| 16400  | cromo brillo | ø16 mm x 4 m   | 20       | 9,7000  | 164007  |
| 19200  | cromo brillo | ø19 mm x 2 m   | 15       | 5,7000  | 192000  |
| 19400  | cromo brillo | ø19 mm x 4 m   | 15       | 11,4000 | 194004  |
| 20400  | cromo brillo | ø25 mm x 4 m   | 8        | 14,7500 | 204000  |

Precio por tubo. Espesor 0,8 mm - Price per tube. 0,80 thick.



### TUBO ARMARIO OVALADO ACERO

Steel oval tube cabinet

| código | acabado      | medida         | embalaje | precio  | 8431488 |
|--------|--------------|----------------|----------|---------|---------|
| Nº     |              |                |          | €       |         |
| 25200  | cromo brillo | 25x15 mm x 2 m | 14       | 6,4500  | 252001  |
| 25400  | cromo brillo | 25x15 mm x 4 m | 14       | 12,9000 | 254005  |
| 25201  | latonado     | 25x15 mm x 2 m | 14       | 9,4000  | 252018  |
| 25401  | latonado     | 25x15 mm x 4 m | 14       | 18,8000 | 254012  |

Precio por tubo. Espesor 0,8 mm - Price per tube. 0,80 thick



### TUBO ARMARIO RETRACTIL

Shrink tube cabinet

| código | acabado      | medida         | embalaje | precio | 8431488 |
|--------|--------------|----------------|----------|--------|---------|
| Nº     |              |                |          | €      |         |
| 30402  | cromo brillo | ø 16 mm x 1 m  | 5        | 2,6800 | 304021  |
| 30403  | cromo brillo | ø 16 mm x 2 m  | 5        | 5,3600 | 304038  |
| 30404  | cromo brillo | ø 19 mm x 1 m  | 5        | 3,0800 | 304045  |
| 30405  | cromo brillo | ø 19 mm x 2 m  | 5        | 6,1600 | 304052  |
| 30406  | cromo brillo | 25x15 mm x 1 m | 5        | 4,0300 | 304069  |
| 30407  | cromo brillo | 25x15 mm x 2 m | 5        | 8,0600 | 304076  |

Retractilado individualmente - Individual shrink  
Incluye código de barras individual - Includes individual barcode



# Complementos armario y mueble

## Cabinet and furniture accesories



### CASQUILLO TUBO

Cap tube

| código | acabado   | medida | embalaje | precio | 8431488 |
|--------|-----------|--------|----------|--------|---------|
| Nº     |           |        |          | €      |         |
| 70121  | niquelado | 12 mm  | 250      | 0,3750 | 701219  |
| 70161  | niquelado | 16 mm  | 200      | 0,4790 | 701615  |
| 70191  | niquelado | 19 mm  | 200      | 0,5750 | 701912  |

Latón - Brass



### SOPORTE LATERAL TUBO REDONDO

Lateral support round tube

| código | acabado       | medida | embalaje | precio | 8431488 |
|--------|---------------|--------|----------|--------|---------|
| Nº     |               |        |          | €      |         |
| 70251  | chromo brillo | 25 mm  | 50       | 0,9250 | 702513  |
| 70252  | latonado      | 25 mm  | 50       | 0,9750 | 702520  |
| 70253  | aluminio      | 25 mm  | 50       | 1,0650 | 702537  |

Zamak - Zamak



### SOPORTE LATERAL TUBO OVAL

Lateral support oval tube

| código | acabado   | medida | embalaje | precio | 8431488 |
|--------|-----------|--------|----------|--------|---------|
| Nº     |           |        |          | €      |         |
| 75251  | niquelado | 15 mm  | 250      | 0,2980 | 752518  |
| 75252  | latonado  | 15 mm  | 250      | 0,2980 | 752525  |
| 75253  | aluminio  | 15 mm  | 250      | 0,2980 | 752532  |

Zamak - Zamak

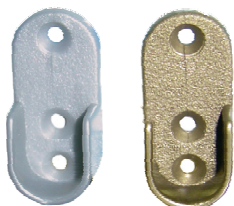

### SOPORTE LATERAL TUBO OVAL

Lateral support oval tube

| código | acabado   | medida   | embalaje | precio | 8431488 |
|--------|-----------|----------|----------|--------|---------|
| Nº     |           |          |          | €      |         |
| 77251  | niquelado | 30x15 mm | 1000     | 0,1070 | 772516  |
| 77252  | latonado  | 30x15 mm | 1000     | 0,1070 | 772523  |

Nylon - Nylon

# Complementos armario y mueble

## Cabinet and furniture accesories

### SOPORTE LATERAL TUBO OVAL

Lateral support oval tube

| código | acabado | medida | embalaje | precio | 8431488 |
|--------|---------|--------|----------|--------|---------|
| Nº     |         |        |          | €      |         |
| 60801  | blanco  | 17 mm  | 100      | 0,0500 | 608013  |
| 60802  | marrón  | 17 mm  | 100      | 0,0500 | 608020  |

Plástico - Plastic

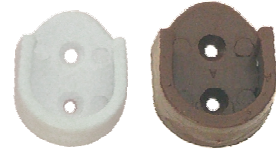

### SOPORTE CENTRAL TUBO REDONDO

Central support round tube

| código | acabado   | medida | embalaje | precio | 8431488 |
|--------|-----------|--------|----------|--------|---------|
| Nº     |           |        |          | €      |         |
| 71121  | niquelado | 12 mm  | 50       | 1,1000 | 711218  |
| 71161  | niquelado | 16 mm  | 50       | 1,1500 | 711614  |
| 71191  | niquelado | 19 mm  | 50       | 1,1750 | 711911  |

Zamak - Zamak



### SOPORTE CENTRAL TUBO REDONDO

Central support round tube

| código | acabado       | medida | embalaje | precio | 8431488 |
|--------|---------------|--------|----------|--------|---------|
| Nº     |               |        |          | €      |         |
| 71251  | chromo brillo | 25 mm  | 50       | 1,4880 | 712512  |
| 71252  | latonado      | 25 mm  | 50       | 1,4880 | 712529  |
| 71253  | aluminio      | 25 mm  | 50       | 1,8070 | 712536  |

Zamak - Zamak



# Complementos armario y mueble

## Cabinet and furniture accesories



### SOPORTE CENTRAL TUBO OVAL

Central support oval tube

| código | acabado   | medida   | embalaje | precio | 8431488 |
|--------|-----------|----------|----------|--------|---------|
| Nº     |           |          |          | €      |         |
| 73251  | niquelado | 25x15 mm | 50       | 1,2500 | 732510  |
| 73252  | latonado  | 25x15 mm | 50       | 1,3250 | 732527  |

Zamak - Zamak



### SOPORTE CENTRAL TUBO OVAL

Central support oval tube

| código | acabado   | medida   | embalaje | precio | 8431488 |
|--------|-----------|----------|----------|--------|---------|
| Nº     |           |          |          | €      |         |
| 73301  | niquelado | 30x15 mm | 50       | 0,8750 | 733012  |
| 73302  | latonado  | 30x15 mm | 50       | 1,0000 | 733029  |
| 73303  | aluminio  | 30x15 mm | 50       | 1,0500 | 733036  |

Zamak - Zamak



### SOPORTE CENTRAL TUBO OVAL REGULABLE

Central support oval tube adjustable

| código | acabado       | medida   | embalaje | precio | 8431488 |
|--------|---------------|----------|----------|--------|---------|
| Nº     |               |          |          | €      |         |
| 73304  | chromo brillo | 30x15 mm | 50       | 3,5000 | 733043  |
| 73305  | latonado      | 30x15 mm | 50       | 3,5000 | 733050  |
| 73306  | aluminio      | 30x15 mm | 50       | 4,2500 | 733067  |

Zamak - Zamak

Regulación de 90 a 125 mm - Regulation of 90 to 125 mm

# Complementos armario y mueble

## Cabinet and furniture accesories

### SOPORTE CERRADO TUBO REDONDO

Close support round tube

| código | acabado | medida | embalaje | precio | 8431488 |
|--------|---------|--------|----------|--------|---------|
| Nº     |         |        |          | €      |         |
| 72121  | níquel  | 12 mm  | 50       | 1,1750 | 721217  |
| 72161  | níquel  | 16 mm  | 50       | 1,2250 | 721613  |
| 72191  | níquel  | 19 mm  | 50       | 1,2500 | 721910  |

Zamak - Zamak



### SOPORTE CERRADO TUBO OVAL

Close support oval tube

| código | acabado   | medida   | embalaje | precio | 8431488 |
|--------|-----------|----------|----------|--------|---------|
| Nº     |           |          |          | €      |         |
| 74251  | níquelado | 25X15 mm | 50       | 1,3630 | 742519  |
| 74301  | níquelado | 30X15 mm | 50       | 1,4250 | 743011  |
| 74252  | latonado  | 25X15 mm | 50       | 1,4380 | 742526  |
| 74302  | latonado  | 30X15 mm | 50       | 1,5000 | 743028  |

Zamak - Zamak



### SOPORTE CERRADO TUBO OVAL REGULABLE

Close support oval tube adjustable

| código | acabado       | medida   | embalaje | precio | 8431488 |
|--------|---------------|----------|----------|--------|---------|
| Nº     |               |          |          | €      |         |
| 74304  | chromo brillo | 30x15 mm | 50       | 3,7500 | 743042  |
| 74305  | latonado      | 30x15 mm | 50       | 3,7500 | 743059  |
| 74306  | aluminio      | 30x15 mm | 50       | 4,8000 | 743066  |

Zamak - Zamak.

Regulación de 90 a 125 mm - Regulation of 90 to 125 mm



# Complementos armario y mueble

## Cabinet and furniture accesories



### SOPORTE CENTRAL TUBO OVAL

Central support oval tube

| código | acabado  | medida   | embalaje | precio | 8431488 |
|--------|----------|----------|----------|--------|---------|
| Nº     |          |          |          | €      |         |
| 73323  | aluminio | 30x15 mm | 25       | 3,1000 | 733234  |



### SOPORTE CERRADO TUBO OVAL

Close support oval tube

| código | acabado  | medida   | embalaje | precio | 8431488 |
|--------|----------|----------|----------|--------|---------|
| Nº     |          |          |          | €      |         |
| 73324  | aluminio | 30x15 mm | 25       | 3,1000 | 733241  |



### SOPORTE DOBLE ESQUINA TUBO OVAL

Doble corner support oval tube

| código | acabado  | medida   | embalaje | precio | 8431488 |
|--------|----------|----------|----------|--------|---------|
| Nº     |          |          |          | €      |         |
| 73325  | aluminio | 30x15 mm | 25       | 4,8500 | 733258  |



# Complementos armario y mueble

## Cabinet and furniture accesories

### SOPORTE LATERAL





*Lateral support*

| código | acabado   | medida  | embalaje  | precio | 8431488   |
|--------|---|---|---|--------|---|
| Nº     |  |  |  | €      |  |
| 73307  | zincado   | 12 mm   | 25  | 0,4540 | 733074  |



### SOPORTE TECHO





*Roof support*

| código | acabado   | medida  | embalaje  | precio | 8431488   |
|--------|---|---|---|--------|---|
| Nº     |  |  |  | €      |  |
| 73308  | zincado   | 12 mm   | 25  | 0,5450 | 733081  |
| 73316  | blanco  | 12 mm   | 25  | 0,7870 | 733166  |



### SOPORTE FRENTE

*Front support*

| código | acabado   | medida  | embalaje  | precio | 8431488   |
|--------|---|---|---|--------|---|
| Nº     |  |  |  | €      |  |
| 73309  | zincado   | 12 mm   | 25  | 0,6050 | 733098  |
| 73315  | blanco  | 12 mm   | 25  | 1,0260 | 733159  |



# Complementos armario y mueble

## Cabinet and furniture accesories



### SOPORTE EXTENSIBLE

*Extensible support*

| código | acabado | medida | embalaje | precio | 8431488 |
|--------|---------|--------|----------|--------|---------|
| Nº     |         |        |          | €      |         |
| 73310  | zincado | 12 mm  | 25       | 1,2640 | 733104  |
| 73317  | blanco  | 12 mm  | 25       | 1,9380 | 733173  |

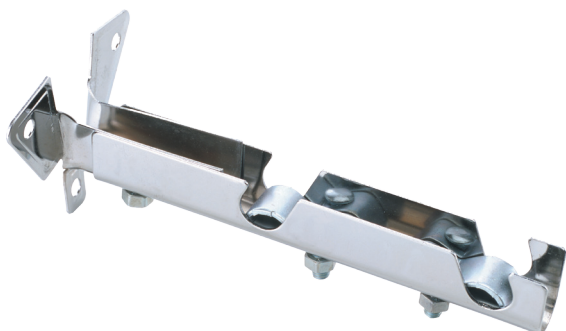

### SOPORTE DOBLE

*Double support*

| código | acabado | medida | embalaje | precio | 8431488 |
|--------|---------|--------|----------|--------|---------|
| Nº     |         |        |          | €      |         |
| 73311  | zincado | 12 mm  | 25       | 1,4300 | 733111  |



### SOPORTE DOBLE TECHO

*Double hanging support*

| código | acabado | medida | embalaje | precio | 8431488 |
|--------|---------|--------|----------|--------|---------|
| Nº     |         |        |          | €      |         |
| 73312  | zincado | 12 mm  | 25       | 1,7170 | 733128  |

# Complementos armario y mueble

## Cabinet and furniture accesories

### REMATE BELLOTA PLÁSTICO

Plastic acorn end

| código | acabado       | medida | embalaje | precio | 8431488 |
|--------|---------------|--------|----------|--------|---------|
| Nº     |               |        |          | €      |         |
| 73313  | chromo brillo | 12 mm  | 100      | 0,2860 | 733135  |
| 73318  | blanco        | 12 mm  | 100      | 0,1380 | 733180  |



### ANILLA TUBO PLÁSTICO

Plastic tube ring

| código | acabado       | medida | embalaje | precio | 8431488 |
|--------|---------------|--------|----------|--------|---------|
| Nº     |               |        |          | €      |         |
| 73314  | chromo brillo | 12 mm  | 100      | 0,3280 | 733142  |
| 73319  | blanco        | 12 mm  | 100      | 0,1380 | 733197  |



### CORCHETE CORTINA

Curtain bracket

| código | acabado | material | embalaje | precio | 8431488 |
|--------|---------|----------|----------|--------|---------|
| Nº     |         |          |          | €      |         |
| 73322  | blanco  | plástico | 200      | 0,0170 | 733227  |



### SOPORTE CORTINA

Curtain support

| código | acabado | medida  | embalaje | precio | 8431488 |
|--------|---------|---------|----------|--------|---------|
| Nº     |         |         |          | €      |         |
| 73320  | zincado | pequeño | 200      | 0,0920 | 733203  |
| 73321  | zincado | grande  | 200      | 0,0920 | 733210  |



# Complementos armario y mueble

## Cabinet and furniture accesories

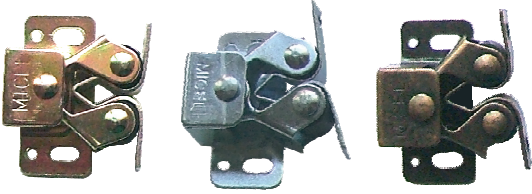

### CIERRE 2 RODILLOS GOMA

Latch 2 rolls rubber

| código | acabado     | espesor | embalaje | precio | 8431488 |
|--------|-------------|---------|----------|--------|---------|
| Nº     |             |         |          | €      |         |
| 10089  | bicromatado | 1 mm    | 100/1000 | 0,213  | 100890  |
| 10894  | cuero       | 1 mm    | 100/1000 | 0,213  | 108940  |
| 10891  | zincado     | 1 mm    | 100/1000 | 0,213  | 108919  |

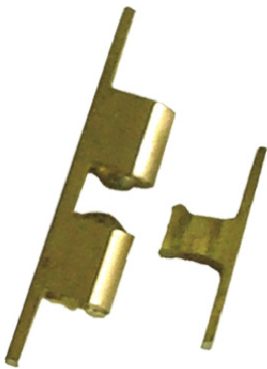

### CIERRE BOLA

Ball latch

| código | acabado | medida | embalaje | precio | 8431488 |
|--------|---------|--------|----------|--------|---------|
| Nº     |         |        |          | €      |         |
| 10244  | latón   | 44 mm  | 50       | 1,2500 | 102443  |
| 10250  | latón   | 50 mm  | 50       | 1,6300 | 102504  |
| 10270  | latón   | 70 mm  | 50       | 3,5000 | 102702  |

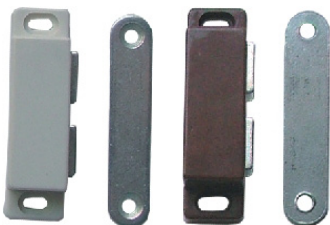

### CIERRE MAGNÉTICO

Magnetic latch

| código | acabado | medida | embalaje | precio | 8431488 |
|--------|---------|--------|----------|--------|---------|
| Nº     |         |        |          | €      |         |
| 10901  | blanco  | 42 mm  | 100/1000 | 0,2820 | 109015  |
| 10911  | blanco  | 56 mm  | 50/500   | 0,4910 | 109114  |
| 10902  | marrón  | 42 mm  | 100/1000 | 0,2820 | 109022  |
| 10912  | marrón  | 56 mm  | 50/500   | 0,4910 | 109121  |



### IMÁN PIZARRA

Magnetic slate

| código | acabado  | medida | embalaje | precio | 8431488 |
|--------|----------|--------|----------|--------|---------|
| Nº     |          |        |          | €      |         |
| 10925  | blanco   | 25 mm  | 100      | 0,4250 | 109251  |
| 10926  | marrón   | 25 mm  | 100      | 0,4250 | 109268  |
| 10927  | negro    | 25 mm  | 100      | 0,4250 | 109275  |
| 10928  | rojo     | 25 mm  | 100      | 0,4250 | 109282  |
| 10929  | amarillo | 25 mm  | 100      | 0,4250 | 109299  |
| 10930  | azul     | 25 mm  | 100      | 0,4250 | 090047  |
| 10931  | surtido  | 25 mm  | 100      | 0,4250 | 090054  |

# Complementos armario y mueble

## Cabinet and furniture accesories

### CIERRE MAGNÉTICO C/MUELLE SENCILLO

*Magnetic latch with single spring*

| código | acabado | medida   | embalaje | precio | 8431488 |
|--------|---------|----------|----------|--------|---------|
| Nº     |         |          |          | €      |         |
| 10907  | blanco  | 47x43 mm | 100      | 0,4950 | 109077  |
| 10908  | negro   | 47x43 mm | 100      | 0,4950 | 109084  |

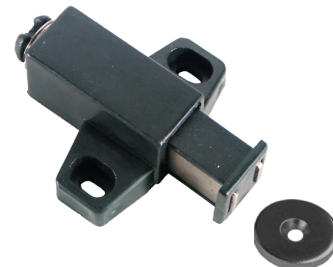

### CIERRE MAGNÉTICO C/MUELLE DOBLE

*Magnetic latch with double spring*

| código | acabado | medida   | embalaje | precio | 8431488 |
|--------|---------|----------|----------|--------|---------|
| Nº     |         |          |          | €      |         |
| 10909  | blanco  | 47x74 mm | 25       | 0,8410 | 109091  |
| 10910  | negro   | 47x74 mm | 25       | 0,8410 | 109107  |



### CIERRE TIP-LATCH (TOCA-TOCA)

*Tip-latch (touch-touch)*

| código | acabado  | medida   | embalaje | precio | 8431488 |
|--------|----------|----------|----------|--------|---------|
| Nº     |          |          |          | €      |         |
| 10905  | latonado | 53x29 mm | 50       | 2,2500 | 109053  |
| 10906  | zincado  | 53x29 mm | 50       | 2,2500 | 109060  |

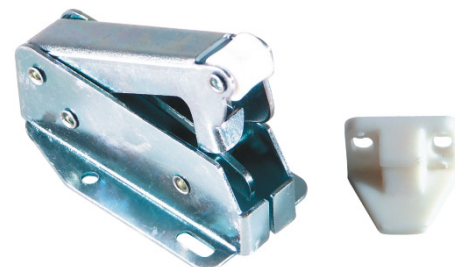

### CIERRE MINI-LATCH (TOCA-TOCA)

*Mini-latch (touch-touch)*

| código | acabado         | medida   | embalaje | precio | 8431488 |
|--------|-----------------|----------|----------|--------|---------|
| Nº     |                 |          |          | €      |         |
| 10903  | níquel / blanco | 35x28 mm | 100      | 1,9130 | 109039  |
| 10904  | níquel / marrón | 35x28 mm | 100      | 1,9130 | 109046  |

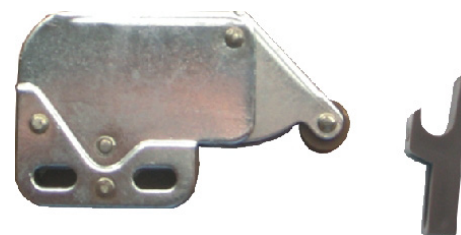

# Complementos armario y mueble

## Cabinet and furniture accesories



### EXPULSOR AMORTIGUADOR C/BASE

Shock ejector with base

| código | acabado | medida/ expulsa | embalaje | precio | 8431488 |
|--------|---------|-----------------|----------|--------|---------|
| Nº     |         |                 |          | €      |         |
| 10914  | gris    | 75 mm / 13 mm   | 100      | 3,0820 | 109145  |
| 10916  | gris    | 125 mm / 40 mm  | 50       | 3,1880 | 109169  |



### EXPULSOR IMÁN C/BASE

Magnetic ejector with base

| código | acabado | medida/ expulsa | embalaje | precio | 8431488 |
|--------|---------|-----------------|----------|--------|---------|
| Nº     |         |                 |          | €      |         |
| 10913  | gris    | 75 mm / 13 mm   | 100      | 3,9170 | 109138  |
| 10915  | gris    | 125 mm / 40 mm  | 50       | 3,9620 | 109152  |

Incluye placa - Includes plate



### EXPULSOR AMORTIGUADOR EMBUTIR

Shock ejector mortise

| código | acabado | medida/ expulsa | embalaje | precio | 8431488 |
|--------|---------|-----------------|----------|--------|---------|
| Nº     |         |                 |          | €      |         |
| 10922  | gris    | 68 mm / 19 mm   | 100      | 2,3380 | 109220  |
| 10918  | gris    | 116 mm / 40 mm  | 100      | 2,6860 | 109183  |



### EXPULSOR IMÁN EMBUTIR

Magnetic ejector mortise

| código | acabado | medida/ expulsa | embalaje | precio | 8431488 |
|--------|---------|-----------------|----------|--------|---------|
| Nº     |         |                 |          | €      |         |
| 10921  | gris    | 68 mm / 19 mm   | 100      | 2,5500 | 090030  |
| 10917  | gris    | 116 mm / 40 mm  | 100      | 2,8880 | 109176  |

Incluye placa - Includes plate

# Complementos armario y mueble

## Cabinet and furniture accessories

### EXPULSOR EMBUTIR REGULABLE

Mortise ejector adjustable

| código | acabado / tipo      | medida / expulsa | embalaje | precio | 8431488 |
|--------|---------------------|------------------|----------|--------|---------|
| Nº     |                     |                  |          | €      |         |
| 10923  | gris / imán         | 50 mm / 17 mm    | 100      | 2,8690 | 109237  |
| 10924  | gris / amortiguador | 50 mm / 17 mm    | 100      | 2,6570 | 109244  |



Incluye placa - Includes plate

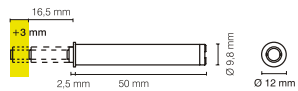

### PLACA CIERRE MAGNÉTICO

Plate for magnetic latch

| código | acabado / tipo | tipo / medida      | embalaje | precio | 8431488 |
|--------|----------------|--------------------|----------|--------|---------|
| Nº     |                |                    |          | €      |         |
| 00076  | zincado        | clavo / 15 mm      | 100      | 0,2020 | 000763  |
| 00077  | níquel         | adhesivo / 15 mm   | 100      | 0,2320 | 000770  |
| 00078  | zincado        | atornillar / 15 mm | 100      | 0,0960 | 000787  |



atornillar

adhesivo

clavo

### SISTEMA AMORTIGUADOR GUÍA

Drawer slide system shock

| código | acabado | medida | embalaje | precio | 8431488 |
|--------|---------|--------|----------|--------|---------|
| Nº     |         |        |          | €      |         |
| 10919  | gris    | 224 mm | 10       | 3,6130 | 109190  |

Freno cierre amortiguado. Deslizamiento suave y silencioso. Reversible, no guarda mano. Sirve para cualquier tipo de guía, puertas correderas de armario, etc. Capacidad de carga 25 kgs. Testado en 40.000 cierres.

Brake closes muffled. Soft and silent slide. Reversible, he does not guard hand. It serves for any type of guide, sliding doors of cupboard, etc. Capacity of load 25 kgs. Tested in 40.000 closings.

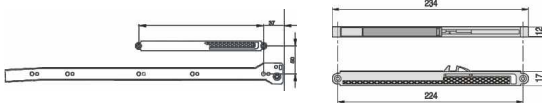



# Complementos armario y mueble

## Cabinet and furniture accessories

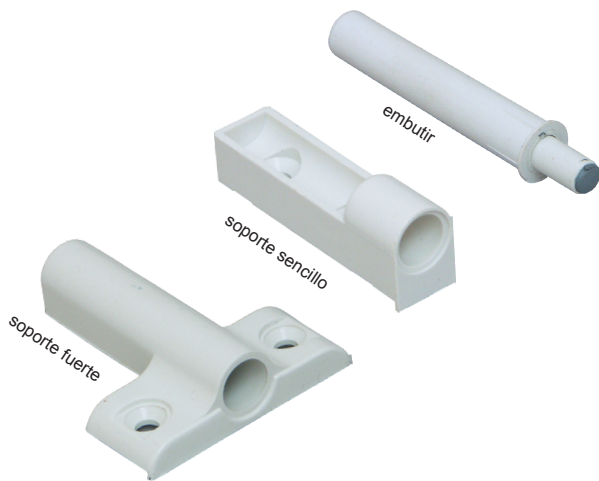

### AMORTIGUADOR EMBUTIR Y ATORNILLAR

*Mortise shock and screw*

| código | acabado | tipo     | embalaje | precio | 8431488 |
|--------|---------|----------|----------|--------|---------|
| Nº     |         |          |          | €      |         |
| 10895  | blanco  | embutir  | 100      | 1,5000 | 108957  |
| 10896  | blanco  | sencillo | 100      | 0,3200 | 108964  |
| 10897  | blanco  | fuerte   | 100      | 0,4500 | 108971  |

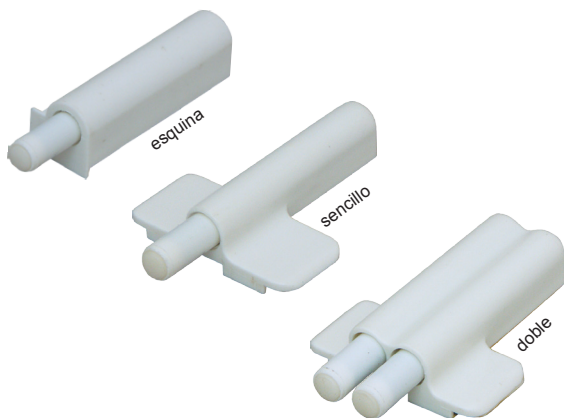

### AMORTIGUADOR ADHESIVO SOBREPONER

*Adhesive shock rim*

| código | acabado | tipo     | embalaje | precio | 8431488 |
|--------|---------|----------|----------|--------|---------|
| Nº     |         |          |          | €      |         |
| 10898  | blanco  | esquina  | 100      | 1,5000 | 108988  |
| 10899  | blanco  | sencillo | 100      | 1,5000 | 108995  |
| 10900  | blanco  | doble    | 50       | 3,2000 | 109008  |

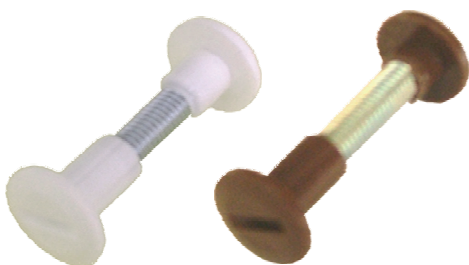

### TORNILLO ENSAMBLE PLÁSTICO

*Plastic screw assembly*

| código | acabado | medida   | embalaje | precio | 8431488 |
|--------|---------|----------|----------|--------|---------|
| Nº     |         |          |          | €      |         |
| 30312  | blanco  | 26-32 mm | 500      | 0,2360 | 303123  |
| 30302  | blanco  | 34-40 mm | 500      | 0,2490 | 303024  |
| 30311  | marrón  | 26-32 mm | 500      | 0,2360 | 303116  |
| 30301  | marrón  | 34-40 mm | 500      | 0,2490 | 303017  |



# Complementos armario y mueble

## Cabinet and furniture accesories

### JGO. TORNILLO UNIÓN KOMBY

Set komby screw union

| código | acabado   | medida  | embalaje | precio | 8431488 |
|--------|-----------|---------|----------|--------|---------|
| Nº     |           |         |          | €      |         |
| 00100  | latonado  | 8x40 mm | 100      | 0,1510 | 001005  |
| 00101  | niquelado | 8x40 mm | 100      | 0,1510 | 001012  |



### TUBO UNIÓN KOMBY

Komby tube union

| código | acabado   | medida  | embalaje | precio | 8431488 |
|--------|-----------|---------|----------|--------|---------|
| Nº     |           |         |          | €      |         |
| 31625  | latonado  | 8x29 mm | 500      | 0,1190 | 316253  |
| 32625  | niquelado | 8x29 mm | 500      | 0,1280 | 326252  |

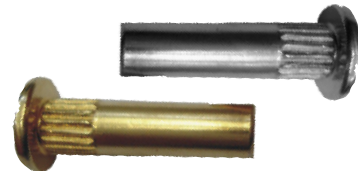

### TORNILLO EMBELLECEDOR KOMBY

Komby cover screw

| código | acabado   | medida   | embalaje | precio | 8431488 |
|--------|-----------|----------|----------|--------|---------|
| Nº     |           |          |          | €      |         |
| 31615  | latonado  | M6x15 mm | 500      | 0,0490 | 316154  |
| 32615  | niquelado | M6x15 mm | 500      | 0,0580 | 326153  |
| 32616  | niquelado | M6x20 mm | 250      | 0,0720 | 326160  |
| 32617  | niquelado | M6x25 mm | 250      | 0,0820 | 326177  |
| 32618  | niquelado | M6x30 mm | 250      | 0,0880 | 326184  |
| 32619  | niquelado | M6x35 mm | 250      | 0,0950 | 326191  |
| 32620  | niquelado | M6x40 mm | 250      | 0,1000 | 326207  |
| 32621  | niquelado | M6x50 mm | 250      | 0,1310 | 326214  |
| 32622  | niquelado | M6x60 mm | 250      | 0,1370 | 326221  |



# Complementos armario y mueble

## Cabinet and furniture accesories

### TUERCA DE ENSAMBLE

*Nut assembly*



| código | acabado   | medida       | embalaje | precio | 8431488 |
|--------|-----------|--------------|----------|--------|---------|
| Nº     |           |              |          | €      |         |
| 40001  | latón     | 13x11x1/4 mm | 250      | 0,2500 | 400013  |
| 40002  | niquelado | 13x11x1/4 mm | 250      | 0,3000 | 400020  |

### ESPARRAGO

*Stud*

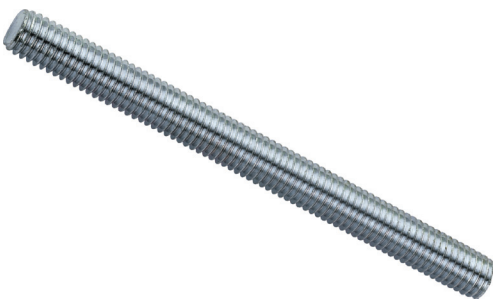

| código | acabado | medida    | embalaje | precio | 8431488 |
|--------|---------|-----------|----------|--------|---------|
| Nº     |         |           |          | €      |         |
| 40020  | zincado | 1/4x20 mm | 500      | 0,1000 | 400204  |
| 40030  | zincado | 1/4x30 mm | 500      | 0,1100 | 400303  |
| 40040  | zincado | 1/4x40 mm | 500      | 0,1500 | 400402  |
| 40050  | zincado | 1/4x50 mm | 500      | 0,1700 | 400501  |
| 40060  | zincado | 1/4x60 mm | 500      | 0,2100 | 400600  |

### ÁNGULO PLÁSTICO CON TAPA

*Plastic corner brace with cap*



| código | acabado | medida   | embalaje | precio | 8431488 |
|--------|---------|----------|----------|--------|---------|
| Nº     |         |          |          | €      |         |
| 61001  | blanco  | 18x20 mm | 200      | 0,1680 | 610016  |
| 61002  | blanco  | 42x20 mm | 100      | 0,2070 | 610023  |
| 61011  | beige   | 18x20 mm | 200      | 0,1680 | 610115  |
| 61012  | beige   | 42x20 mm | 100      | 0,2070 | 610122  |
| 61021  | marrón  | 18x20 mm | 200      | 0,1680 | 610214  |
| 61022  | marrón  | 42x20 mm | 100      | 0,2070 | 610221  |

# Complementos armario y mueble

## Cabinet and furniture accesories

### TORNILLO DE ENSAMBLE

Screw assembly

| código | acabado     | medida   | embalaje | precio | 8431488 |
|--------|-------------|----------|----------|--------|---------|
| Nº     |             |          |          | €      |         |
| 30502  | bicromatado | 41x36 mm | 100      | 0,4000 | 305028  |



### ENGANCHE STRONG PLÁSTICO

Plasting strong coupling

| código | acabado | medida   | embalaje | precio | 8431488 |
|--------|---------|----------|----------|--------|---------|
| Nº     |         |          |          | €      |         |
| 30506  | blanco  | 38x21 mm | 50       | 0,4500 | 305066  |
| 30507  | marrón  | 38x21 mm | 50       | 0,4500 | 305073  |

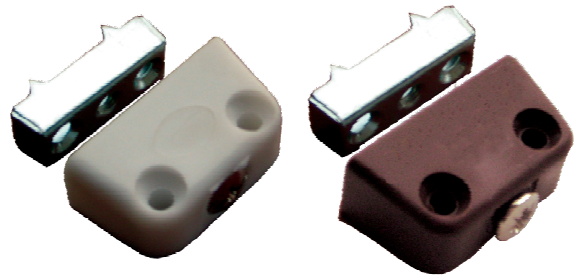

### ENGANCHE STRONG ZAMAK

Zamak strong coupling

| código | acabado | medida   | embalaje | precio | 8431488 |
|--------|---------|----------|----------|--------|---------|
| Nº     |         |          |          | €      |         |
| 30508  | zincado | 38x21 mm | 50       | 0,8500 | 305080  |



# Complementos armario y mueble

## Cabinet and furniture accesories



### UNIÓN PARA PANELES

Union for panels

| código | acabado | montaje    | embalaje | precio | 8431488 |
|--------|---------|------------|----------|--------|---------|
| Nº     |         |            |          | €      |         |
| 30514  | negro   | suspendido | 50       | 0,9500 | 305141  |

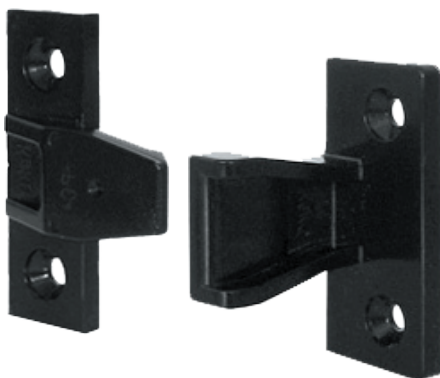
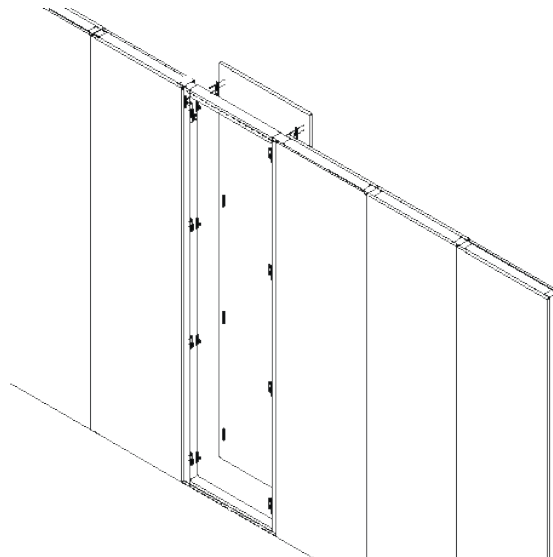
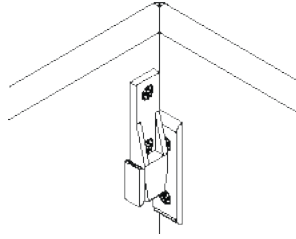

### UNIÓN PARA PANELES

Union for panels

| código | acabado | montaje     | embalaje | precio | 8431488 |
|--------|---------|-------------|----------|--------|---------|
| Nº     |         |             |          | €      |         |
| 30515  | negro   | sobrepuesto | 50       | 1,2500 | 305158  |

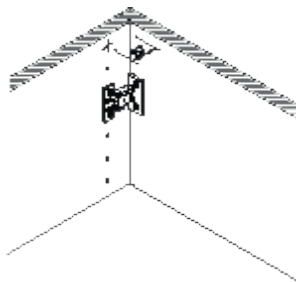





# Complementos armario y mueble

## Cabinet and furniture accesories

### SOPORTE SOMIER





Somier support

| código | acabado   | medida  | embalaje  | precio | 8431488   |
|--------|---|---|---|--------|---|
| Nº     |  |  |  | €      |  |
| 96414  | zincado   | 55x55 mm  | 50  | 0,7000 | 964140  |



### JGO. ENGANCHE CAMA

Set bed hook

| código | acabado   | medida  | embalaje  | precio | 8431488   |
|--------|---|---|---|--------|---|
| Nº     |  |  |  | €      |  |
| 96415  | zincado   | 95x23 mm  | 10  | 4,6750 | 964157  |

1 juego = 8 piezas - 1 Set = 8 pcs



### JGO. ENGANCHE CAMA

Set bed hook

| código | acabado   | medida  | embalaje  | precio | 8431488   |
|--------|---|---|---|--------|---|
| Nº     |  |  |  | €      |  |
| 96416  | bicromatado   | 130 mm  | 12  | 5,6500 | 964164  |

1 juego = 8 piezas - 1 Set = 8 pcs



# Complementos armario y mueble

## Cabinet and furniture accesories



### CIERRE CAJA CANDADO

Lock box

| código | acabado | medida   | embalaje | precio | 8431488 |
|--------|---------|----------|----------|--------|---------|
| Nº     |         |          |          | €      |         |
| 30510  | zincado | 75x23 mm | 100      | 1,7500 | 305103  |



### CIERRE CAJA

Lock box

| código | acabado | medida   | embalaje | precio | 8431488 |
|--------|---------|----------|----------|--------|---------|
| Nº     |         |          |          | €      |         |
| 30511  | zincado | 75x23 mm | 100      | 1,5000 | 305110  |



### CIERRE CAJA

Lock box

| código | acabado | medida   | embalaje | precio | 8431488 |
|--------|---------|----------|----------|--------|---------|
| Nº     |         |          |          | €      |         |
| 30512  | zincado | 53x23 mm | 100      | 0,6500 | 305127  |

# Complementos armario y mueble

## Cabinet and furniture accesories

### CIERRE ESTUCHE

Case latch

| código | acabado  | medida | embalaje | precio | 8431488 |
|--------|----------|--------|----------|--------|---------|
| Nº     |          |        |          | €      |         |
| 30725  | latonado | 25 mm  | 250      | 0,9300 | 307251  |



### PUNTA DE LATÓN

Brass tip

| código | acabado | medida    | embalaje | precio | 8431488 |
|--------|---------|-----------|----------|--------|---------|
| Nº     |         |           |          | €      |         |
| 80026  | latón   | 1,2x11 mm | 1000     | 0,0160 | 800264  |
| 80027  | latón   | 1,5x13 mm | 1000     | 0,0210 | 800271  |
| 80028  | latón   | 1,5x18 mm | 1000     | 0,0290 | 800288  |



### PORTAESTANTE "Ø"

Shelf support "ø"

| código | acabado | medida | embalaje | precio | 8431488 |
|--------|---------|--------|----------|--------|---------|
| Nº     |         |        |          | €      |         |
| 60701  | blanco  | 15 mm  | 1000     | 0,0200 | 607016  |
| 60702  | marrón  | 15 mm  | 1000     | 0,0200 | 607023  |



### PORTAESTANTE ESCUADRA Y CASQUILLO

Bracket shelf support and cap

| código | acabado | tipo         | embalaje | precio | 8431488 |
|--------|---------|--------------|----------|--------|---------|
| Nº     |         |              |          | €      |         |
| 60201  | blanco  | portaestante | 1000     | 0,0320 | 602011  |
| 60211  | blanco  | casquillo    | 1000     | 0,0150 | 602110  |
| 60202  | marrón  | portaestante | 1000     | 0,0320 | 602028  |
| 60212  | marrón  | casquillo    | 1000     | 0,0150 | 602127  |



# Complementos armario y mueble

## Cabinet and furniture accesories

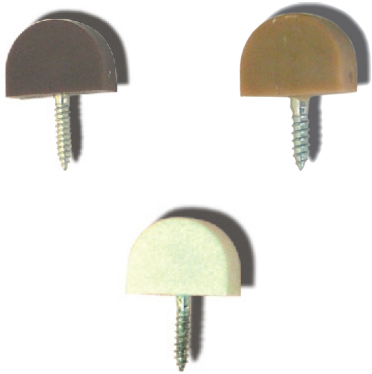

### PORTAESTANTE VITRINA

Show case shelf support

| código | acabado | tipo    | embalaje | precio | 8431488 |
|--------|---------|---------|----------|--------|---------|
| Nº     |         |         |          | €      |         |
| 60401  | blanco  | pequeño | 1000     | 0,0310 | 604015  |
| 60405  | blanco  | pequeño | 100      | 0,0390 | 604053  |
| 60411  | blanco  | grande  | 500      | 0,0520 | 604114  |
| 60415  | blanco  | grande  | 100      | 0,0660 | 604152  |
| 60402  | marrón  | pequeño | 1000     | 0,0310 | 604022  |
| 60406  | marrón  | pequeño | 100      | 0,0390 | 604060  |
| 60412  | marrón  | grande  | 500      | 0,0520 | 604121  |
| 60416  | marrón  | grande  | 100      | 0,0660 | 604169  |
| 60403  | beige   | pequeño | 1000     | 0,0350 | 604039  |
| 60407  | beige   | pequeño | 100      | 0,0440 | 604077  |
| 60413  | beige   | grande  | 500      | 0,0620 | 604138  |
| 60417  | beige   | grande  | 100      | 0,0800 | 604176  |
| 60404  | pino    | pequeño | 1000     | 0,0350 | 604046  |
| 60414  | pino    | grande  | 500      | 0,0620 | 604145  |

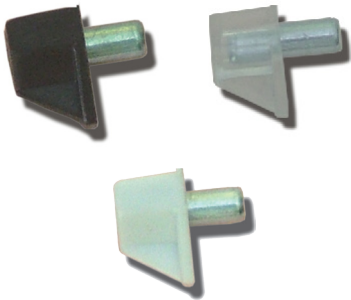

### PORTAESTANTE SAFETY

Safety shelf support

| código | acabado      | medida | embalaje | precio | 8431488 |
|--------|--------------|--------|----------|--------|---------|
| Nº     |              |        |          | €      |         |
| 60301  | blanco       | 5 mm   | 1000     | 0,0320 | 603018  |
| 60307  | blanco       | 5 mm   | 100      | 0,0390 | 603070  |
| 60302  | marrón       | 5 mm   | 1000     | 0,0320 | 603025  |
| 60308  | marrón       | 5 mm   | 100      | 0,0390 | 603087  |
| 60303  | transparente | 5 mm   | 1000     | 0,0320 | 603032  |
| 60309  | transparente | 5 mm   | 100      | 0,0390 | 603094  |
| 60306  | beige        | 5 mm   | 1000     | 0,0360 | 603063  |
| 60310  | beige        | 5 mm   | 100      | 0,0430 | 603100  |



### PORTAESTANTE SAFETY

Safety shelf support

| código | acabado      | medida | embalaje | precio | 8431488 |
|--------|--------------|--------|----------|--------|---------|
| Nº     |              |        |          | €      |         |
| 60304  | transparente | 3 mm   | 1000     | 0,0320 | 603049  |
| 60311  | transparente | 3 mm   | 100      | 0,0390 | 603117  |



### PORTAESTANTE SAFETY LARGO

Long safety shelf support

| código | acabado      | medida        | embalaje | precio | 8431488 |
|--------|--------------|---------------|----------|--------|---------|
| Nº     |              |               |          | €      |         |
| 60305  | transparente | tablero 16 mm | 500      | 0,0640 | 603056  |



# Complementos armario y mueble

## Cabinet and furniture accesories

### PORTAESTANTE CON ARANDELA

Shelf support with washer

| código | acabado  | medida  | embalaje | precio | 8431488 |
|--------|----------|---------|----------|--------|---------|
| Nº     |          |         |          | €      |         |
| 31011  | latonado | 5x16 mm | 2500     | 0,0180 | 310114  |
| 31021  | latonado | 5x16 mm | 100      | 0,0220 | 310213  |
| 31013  | zincado  | 5x16 mm | 2500     | 0,0180 | 310138  |
| 31023  | zincado  | 5x16 mm | 100      | 0,0220 | 310237  |
| 31012  | negro    | 5x16 mm | 2500     | 0,0180 | 310121  |
| 31022  | negro    | 5x16 mm | 100      | 0,0220 | 310220  |



### PORTAESTANTE CON ARANDELA

Shelf support with washer

| código | acabado | medida    | embalaje | precio | 8431488 |
|--------|---------|-----------|----------|--------|---------|
| Nº     |         |           |          | €      |         |
| 31017  | zincado | 3-5x16 mm | 1000     | 0,0640 | 310176  |
| 31014  | zincado | 4-5x16 mm | 1000     | 0,0240 | 310145  |



### PORTAESTANTE CRISTAL

Glass shelf support

| código | acabado | medida  | embalaje | precio | 8431488 |
|--------|---------|---------|----------|--------|---------|
| Nº     |         |         |          | €      |         |
| 31016  | zincado | 3x16 mm | 500      | 0,0510 | 310169  |
| 31015  | zincado | 5x16 mm | 500      | 0,0390 | 310152  |



# Complementos armario y mueble

## Cabinet and furniture accesories

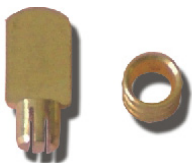

### PORTAESTANTE Y CASQUILLO PRESIÓN

Shelf support and pressure cap

| código | acabado   | tipo         | embalaje | precio | 8431488 |
|--------|-----------|--------------|----------|--------|---------|
| Nº     |           |              |          | €      |         |
| 31511  | latón     | portaestante | 250      | 0,3710 | 315119  |
| 31521  | latón     | casquillo    | 500      | 0,0870 | 315218  |
| 31512  | niquelado | portaestante | 250      | 0,4120 | 315126  |
| 31522  | niquelado | casquillo    | 500      | 0,0920 | 315225  |

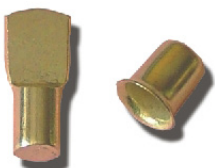

### PORTAESTANTE Y CASQUILLO PRESIÓN

Shelf support and pressure cap

| código | acabado  | tipo         | embalaje | precio | 8431488 |
|--------|----------|--------------|----------|--------|---------|
| Nº     |          |              |          | €      |         |
| 31311  | latonado | portaestante | 500      | 0,0630 | 313115  |
| 31321  | latonado | casquillo    | 1000     | 0,0250 | 313214  |

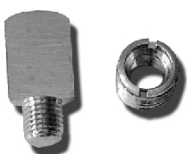

### PORTAESTANTE Y CASQUILLO ROSCADO

Shelf support and screwed cap

| código | acabado   | tipo         | embalaje | precio | 8431488 |
|--------|-----------|--------------|----------|--------|---------|
| Nº     |           |              |          | €      |         |
| 31411  | latón     | portaestante | 250      | 0,4350 | 314112  |
| 31421  | latón     | casquillo    | 500      | 0,1490 | 314211  |
| 31412  | niquelado | portaestante | 250      | 0,4940 | 314129  |
| 31422  | niquelado | casquillo    | 500      | 0,1920 | 314228  |



### PORTAESTANTE REDONDO

Round shelf support

| código | acabado   | medida      | embalaje | precio | 8431488 |
|--------|-----------|-------------|----------|--------|---------|
| Nº     |           |             |          | €      |         |
| 31211  | latón     | 14x4x1/8 mm | 250      | 0,2750 | 312118  |
| 31212  | niquelado | 14x4x1/8 mm | 250      | 0,4070 | 312125  |

# Complementos armario y mueble

## Cabinet and furniture accesories

### PORTAESTANTE CRISTAL CON GOMA

*Glass shelf support with rubber*

| código | acabado   | medida  | embalaje | precio | 8431488 |
|--------|-----------|---------|----------|--------|---------|
| Nº     |           |         |          | €      |         |
| 31111  | latón     | 8x18 mm | 250      | 0,2520 | 311111  |
| 31112  | niquelado | 8x18 mm | 250      | 0,2880 | 311128  |

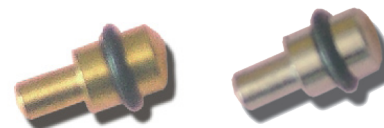

### PORTAESTANTE CRISTAL

*Glass shelf support*

| código | acabado   | medida | embalaje | precio | 8431488 |
|--------|-----------|--------|----------|--------|---------|
| Nº     |           |        |          | €      |         |
| 31603  | niquelado | 5 mm   | 500      | 0,1700 | 316031  |



### PORTAESTANTE CRISTAL CON VENTOSA

*Glass shelf support with rubber*

| código | acabado   | medida | embalaje | precio | 8431488 |
|--------|-----------|--------|----------|--------|---------|
| Nº     |           |        |          | €      |         |
| 31601  | latonado  | 5 mm   | 500      | 0,2510 | 316017  |
| 31602  | niquelado | 5 mm   | 500      | 0,2510 | 316024  |

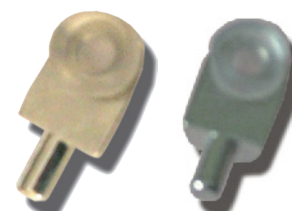

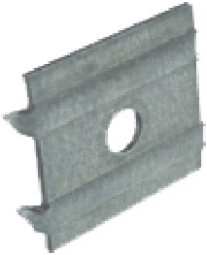

### GRAPA TRASERA

Rear clamp

| código | acabado | medida   | embalaje | precio | 8431488 |
|--------|---------|----------|----------|--------|---------|
| Nº     |         |          |          | €      |         |
| 30800  | zincado | 23x17 mm | 1000     | 0,0370 | 308005  |



### TUERCA PUA

Pua nut

| código | acabado | medida | embalaje | precio | 8431488 |
|--------|---------|--------|----------|--------|---------|
| Nº     |         |        |          | €      |         |
| 30804  | zincado | M4     | 100      | 0,0830 | 308043  |
| 30806  | zincado | M6     | 100      | 0,1000 | 308067  |
| 30808  | zincado | M8     | 100      | 0,1300 | 308081  |
| 30810  | zincado | M10    | 100      | 0,1560 | 308104  |



### TUERCA EMBUTIR

Mortise nut

| código | acabado     | medida       | embalaje | precio | 8431488 |
|--------|-------------|--------------|----------|--------|---------|
| Nº     |             |              |          | €      |         |
| 30828  | bicromatado | M6x10x12 mm  | 250      | 0,2130 | 308289  |
| 30829  | bicromatado | M6x12x14 mm  | 250      | 0,2340 | 308296  |
| 30830  | bicromatado | M8x13x16 mm  | 250      | 0,2980 | 308302  |
| 30835  | bicromatado | M10x15x17 mm | 250      | 0,3860 | 308357  |



### TUERCA EMBOLO

Piston nut

| código | acabado | medida      | embalaje | precio | 8431488 |
|--------|---------|-------------|----------|--------|---------|
| Nº     |         |             |          | €      |         |
| 30801  | zincado | M6x10x14 mm | 250      | 0,1410 | 308012  |

Tornillo Komby disponible en página: 217





Komby cover screw available on page: 217

# Complementos armario y mueble

## Cabinet and furniture accesories

### TUERCA EMBUTIR NYLON





*Mortise nut nylon*

| código | acabado   | medida  | embalaje  | precio | 8431488   |
|--------|---|---|---|--------|---|
| Nº     |  |  |  | €      |  |
| 30831  | blanco  | M6x11x11 mm   | 250   | 0,0520 | 308319  |



### TUERCA EMBUTIR LATÓN EXPANSIBLE





*Brass mortise nut expanding*

| código | acabado   | medida  | embalaje  | precio | 8431488   |
|--------|---|---|---|--------|---|
| Nº     |  |  |  | €      |  |
| 30833  | latón   | M6x12x8 mm  | 200   | 0,1370 | 308333  |



### TACO LATÓN GRAFILADO

*Brass fixing*

| código | acabado   | medida  | embalaje  | precio | 8431488   |
|--------|---|---|---|--------|---|
| Nº     |  |  |  | €      |  |
| 30836  | latón   | M6x23x8 mm  | 100   | 0,1920 | 308364  |
| 30837  | latón   | M8x28x10 mm   | 100   | 0,2150 | 308371  |



# Complementos armario y mueble

## Cabinet and furniture accesories

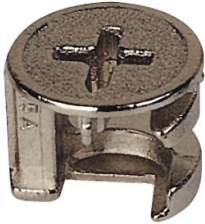

### EXCÉNTRICA Ø15 ZAMAK

Connector housing  $\varnothing 15$  zamak

| código | acabado | medida/tablero | embalaje | precio | 8431488 |
|--------|---------|----------------|----------|--------|---------|
| Nº     |         |                |          | €      |         |
| 30811  | zincado | 12x7,5 mm/15   | 200      | 0,0830 | 308111  |
| 30812  | zincado | 12,5x8 mm/16   | 200      | 0,0830 | 308128  |
| 30813  | zincado | 14x9 mm/18     | 200      | 0,0830 | 308135  |



### PERNO P/EXCÉNTRICA Ø15

Bolt for connector housing  $\varnothing 15$

| código | acabado | medida/rosca       | embalaje | precio | 8431488 |
|--------|---------|--------------------|----------|--------|---------|
| Nº     |         |                    |          | €      |         |
| 30814  | zincado | 45x34x11 mm/madera | 200      | 0,0495 | 308142  |
| 30815  | zincado | 42x34x8 mm/M6      | 200      | 0,0520 | 308159  |



### TAPÓN P/EXCÉNTRICA Ø15

Cup connector housing  $\varnothing 15$

| código | acabado | medida              | embalaje | precio | 8431488 |
|--------|---------|---------------------|----------|--------|---------|
| Nº     |         |                     |          | €      |         |
| 30816  | blanco  | $\varnothing 17$ mm | 200      | 0,1000 | 308166  |
| 30817  | marrón  | $\varnothing 17$ mm | 200      | 0,1000 | 308173  |
| 30818  | negro   | $\varnothing 17$ mm | 200      | 0,1000 | 308180  |



### ENGANCHE EXCÉNTRICA ENCAPSULADA Ø20

Connector housing  $\varnothing 20$

| código | acabado | medida/tablero | embalaje | precio | 8431488 |
|--------|---------|----------------|----------|--------|---------|
| Nº     |         |                |          | €      |         |
| 30819  | níquel  | 13x8 mm/16 mm  | 200      | 0,4890 | 308197  |
| 30820  | blanco  | 13x8 mm/16 mm  | 200      | 0,1470 | 308203  |
| 30821  | marrón  | 13x8 mm/16 mm  | 200      | 0,1470 | 308210  |
| 30822  | negro   | 13x8 mm/16 mm  | 200      | 0,1470 | 308227  |

# Complementos armario y mueble

## Cabinet and furniture accesories

### PERNO P/EXCÉNTRICA Ø20

Screw dowell ø20

| código | acabado | medida  | embalaje | precio | 8431488 |
|--------|---------|---------|----------|--------|---------|
| Nº     |         |         |          | €      |         |
| 30832  | zincado | 6x11 mm | 200      | 0,1280 | 308326  |



### ENGANCHE Ø20

Connector ø20

| código | acabado | medida/ tablero | embalaje | precio | 8431488 |
|--------|---------|-----------------|----------|--------|---------|
| Nº     |         |                 |          | €      |         |
| 30823  | blanco  | 13x8 mm/16 mm   | 200      | 0,0490 | 308234  |
| 30824  | marrón  | 13x8 mm/16 mm   | 200      | 0,0490 | 308241  |
| 30825  | negro   | 13x8 mm/16 mm   | 200      | 0,0490 | 308258  |



tornillo no incluido  
screw not included

### TORNILLO ENGANCHE

Connector screw

| código | acabado | medida/rosca   | embalaje | precio | 8431488 |
|--------|---------|----------------|----------|--------|---------|
| Nº     |         |                |          | €      |         |
| 30826  | zincado | 14x6 mm/madera | 200      | 0,0580 | 308265  |
| 30827  | zincado | 14x M6 mm/M6   | 200      | 0,0470 | 308272  |



### TORNILLO EURO

Euro screw

| código | acabado | medida        | embalaje | precio | 8431488 |
|--------|---------|---------------|----------|--------|---------|
| Nº     |         |               |          | €      |         |
| 30834  | zincado | 5,9x7,7x10 mm | 200      | 0,0220 | 308340  |



### TORNILLO ENSAMBLE

Furniture screw

| código | acabado  | medida  | embalaje | precio | 8431488 |
|--------|----------|---------|----------|--------|---------|
| Nº     |          |         |          | €      |         |
| 30202  | zincado  | 5x50 mm | 1000     | 0,0263 | 302027  |
| 30203  | zincado  | 7x50 mm | 1000     | 0,0405 | 302034  |
| 30212  | pavonado | 5x50 mm | 1000     | 0,0340 | 302126  |
| 30213  | pavonado | 7x50 mm | 1000     | 0,0553 | 302133  |



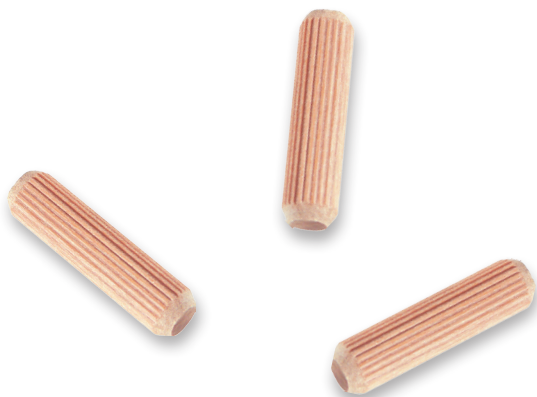

### ESPIGA DE MADERA

Dowel

| código | acabado | medida   | embalaje | precio | 8431488 |
|--------|---------|----------|----------|--------|---------|
| Nº     |         |          |          | €      |         |
| 46300  | madera  | 6x30 mm  | 100      | 0,0250 | 463001  |
| 46350  | madera  | 6x35 mm  | 100      | 0,0250 | 463506  |
| 46400  | madera  | 6x40 mm  | 100      | 0,0250 | 464008  |
| 48300  | madera  | 8x30 mm  | 100      | 0,0250 | 483009  |
| 48350  | madera  | 8x35 mm  | 100      | 0,0250 | 483504  |
| 48400  | madera  | 8x40 mm  | 100      | 0,0250 | 484006  |
| 41035  | madera  | 10x35 mm | 100      | 0,0340 | 410357  |
| 41040  | madera  | 10x40 mm | 100      | 0,0340 | 410401  |
| 41240  | madera  | 12x40 mm | 100      | 0,0440 | 412405  |
| 41440  | madera  | 14x40 mm | 100      | 0,0540 | 414409  |
| 41460  | madera  | 14x60 mm | 100      | 0,0620 | 414607  |

 Presentación en bolsa con solapa - Presentation in bag with flap



### VARILLA ENSAMBLE MADERA

Wood rod assembly

| código | acabado | medida     | embalaje | precio | 8431488 |
|--------|---------|------------|----------|--------|---------|
| Nº     |         |            |          | €      |         |
| 41060  | madera  | 6x1000 mm  | 10       | 1,0000 | 410609  |
| 41080  | madera  | 8x1000 mm  | 10       | 1,1000 | 410807  |
| 41100  | madera  | 10x1000 mm | 10       | 1,3750 | 411002  |
| 41120  | madera  | 12x1000 mm | 10       | 1,6500 | 411200  |
| 41140  | madera  | 14x1000 mm | 10       | 2,0500 | 411408  |
| 41160  | madera  | 16x1000 mm | 10       | 2,7500 | 411606  |

Incluye código de barras individual - Includes individual barcode

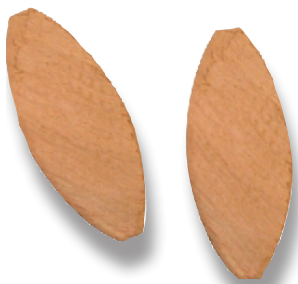

### GALLETAS DE MADERA

Wood cookies

| código | acabado | medida | embalaje | precio | 8431488 |
|--------|---------|--------|----------|--------|---------|
| Nº     |         |        |          | €      |         |
| 41020  | madera  | 20 mm  | 1000     | 0,0440 | 410203  |



# Complementos armario y mueble

## Cabinet and furniture accesories

### TAPÓN ADHESIVO (BLISTER)

Adhesive cap (blister)

| código | acabado     | medida | embalaje | precio | 8431488 |
|--------|-------------|--------|----------|--------|---------|
| Nº     |             |        |          | €      |         |
| 61901  | blanco      | 13 mm  | 1/10     | 2,8500 | 619019  |
| 61902  | blanco poro | 13 mm  | 1/10     | 2,8500 | 619026  |
| 61903  | negro       | 13 mm  | 1/10     | 2,8500 | 619033  |
| 61904  | negro poro  | 13 mm  | 1/10     | 2,8500 | 619040  |
| 61905  | gris        | 13 mm  | 1/10     | 2,8500 | 619057  |
| 61906  | crema       | 13 mm  | 1/10     | 2,8500 | 619064  |
| 61907  | haya        | 13 mm  | 1/10     | 2,8500 | 619071  |
| 61908  | roble       | 13 mm  | 1/10     | 2,8500 | 619088  |
| 61909  | pino        | 13 mm  | 1/10     | 2,8500 | 619095  |
| 61910  | nogal       | 13 mm  | 1/10     | 2,8500 | 619101  |
| 61911  | cerezo      | 13 mm  | 1/10     | 2,8500 | 619118  |
| 61912  | maple       | 13 mm  | 1/10     | 2,8500 | 619125  |
| 61913  | sapeli      | 13 mm  | 1/10     | 2,8500 | 619132  |
| 61914  | wenge       | 13 mm  | 1/10     | 2,8500 | 619149  |
| 61915  | plata       | 13 mm  | 1/10     | 2,8500 | 619156  |

Presentación en blister 100 uds - Presentation in blister 100 units



### TAPÓN ADHESIVO (GRANEL)

Adhesive cap (bulk)

| código | acabado     | medida | embalaje | precio | 8431488 |
|--------|-------------|--------|----------|--------|---------|
| Nº     |             |        |          | €      |         |
| 61941  | blanco      | 13 mm  | 1000     | 0,0200 | 619415  |
| 61942  | blanco poro | 13 mm  | 1000     | 0,0200 | 619422  |
| 61943  | negro       | 13 mm  | 1000     | 0,0200 | 619439  |
| 61944  | negro poro  | 13 mm  | 1000     | 0,0200 | 619446  |
| 61945  | gris        | 13 mm  | 1000     | 0,0200 | 619453  |
| 61946  | crema       | 13 mm  | 1000     | 0,0200 | 619460  |
| 61947  | haya        | 13 mm  | 1000     | 0,0200 | 619477  |
| 61948  | roble       | 13 mm  | 1000     | 0,0200 | 619484  |
| 61949  | pino        | 13 mm  | 1000     | 0,0200 | 619491  |
| 61950  | nogal       | 13 mm  | 1000     | 0,0200 | 619507  |
| 61951  | cerezo      | 13 mm  | 1000     | 0,0200 | 619514  |
| 61952  | maple       | 13 mm  | 1000     | 0,0200 | 619521  |
| 61953  | sapeli      | 13 mm  | 1000     | 0,0200 | 619538  |
| 61954  | wenge       | 13 mm  | 1000     | 0,0200 | 619545  |
| 61955  | plata       | 13 mm  | 1000     | 0,0200 | 619552  |



### TAPÓN ADHESIVO BISAGRA (BLISTER)

Adhesive hinge cap (blister)

| código | acabado | medida | embalaje | precio | 8431488 |
|--------|---------|--------|----------|--------|---------|
| Nº     |         |        |          | €      |         |
| 90733  | blanco  | 35 mm  | 1/10     | 3,8600 | 907338  |
| 90734  | gris    | 35 mm  | 1/10     | 3,8600 | 907345  |
| 90735  | roble   | 35 mm  | 1/10     | 3,8600 | 907352  |
| 90736  | haya    | 35 mm  | 1/10     | 3,8600 | 907369  |

Presentación en blister 8 uds - Presentation in blister 8 units



# Complementos armario y mueble

## Cabinet and furniture accessories



### TAPÓN ADHESIVO BISAGRA (GRANEL)

Adhesive hinge cap (bulk)

| código | acabado | medida | embalaje | precio | 8431488 |
|--------|---------|--------|----------|--------|---------|
| Nº     |         |        |          | €      |         |
| 61995  | blanco  | 35 mm  | 200      | 0,2700 | 619958  |
| 61996  | gris    | 35 mm  | 200      | 0,2700 | 619965  |
| 61997  | roble   | 35 mm  | 200      | 0,2700 | 619972  |
| 61998  | haya    | 35 mm  | 200      | 0,2700 | 619989  |



### TAPÓN ADHESIVO (BLISTER)

Adhesive cap (blister)

| código | acabado | medida | embalaje | precio | 8431488 |
|--------|---------|--------|----------|--------|---------|
| Nº     |         |        |          | €      |         |
| 61961  | blanco  | 17 mm  | 1/10     | 5,2000 | 619613  |
| 61962  | negro   | 17 mm  | 1/10     | 5,2000 | 619620  |
| 61963  | gris    | 17 mm  | 1/10     | 5,2000 | 619637  |
| 61964  | crema   | 17 mm  | 1/10     | 5,2000 | 619644  |
| 61965  | haya    | 17 mm  | 1/10     | 5,2000 | 619651  |
| 61966  | roble   | 17 mm  | 1/10     | 5,2000 | 619668  |
| 61967  | pino    | 17 mm  | 1/10     | 5,2000 | 619675  |
| 61968  | nogal   | 17 mm  | 1/10     | 5,2000 | 619682  |
| 61969  | maple   | 17 mm  | 1/10     | 5,2000 | 619699  |
| 61970  | sapeli  | 17 mm  | 1/10     | 5,2000 | 619705  |
| 61971  | wenge   | 17 mm  | 1/10     | 5,2000 | 619712  |

Presentación en blister 60 uds. - Presentation in blister 60 units.



### TAPÓN ADHESIVO (GRANEL)

Adhesive cap (bulk)

| código | acabado | medida | embalaje | precio | 8431488 |
|--------|---------|--------|----------|--------|---------|
| Nº     |         |        |          | €      |         |
| 61981  | blanco  | 17 mm  | 600      | 0,0500 | 619811  |
| 61982  | negro   | 17 mm  | 600      | 0,0500 | 619828  |
| 61983  | gris    | 17 mm  | 600      | 0,0500 | 619835  |
| 61984  | crema   | 17 mm  | 600      | 0,0500 | 619842  |
| 61985  | haya    | 17 mm  | 600      | 0,0500 | 619859  |
| 61986  | roble   | 17 mm  | 600      | 0,0500 | 619866  |
| 61987  | pino    | 17 mm  | 600      | 0,0500 | 619873  |
| 61988  | nogal   | 17 mm  | 600      | 0,0500 | 619880  |
| 61989  | maple   | 17 mm  | 600      | 0,0500 | 619897  |
| 61990  | sapeli  | 17 mm  | 600      | 0,0500 | 619903  |
| 61991  | wenge   | 17 mm  | 600      | 0,0500 | 619910  |

# Complementos armario y mueble

## Cabinet and furniture accesories

### TAPONES DE PLÁSTICO

Plastic cap

| código | acabado | medida | embalaje | precio | 8431488 |
|--------|---------|--------|----------|--------|---------|
| Nº     |         |        |          | €      |         |
| 60001  | blanco  | 5 mm   | 1000     | 0,0320 | 600017  |
| 60002  | negro   | 5 mm   | 1000     | 0,0320 | 600024  |
| 60003  | marrón  | 5 mm   | 1000     | 0,0320 | 600031  |
| 60004  | beige   | 5 mm   | 1000     | 0,0320 | 600048  |
| 60101  | blanco  | 7 mm   | 1000     | 0,0320 | 601014  |
| 60102  | negro   | 7 mm   | 1000     | 0,0320 | 601021  |
| 60103  | marrón  | 7 mm   | 1000     | 0,0320 | 601038  |
| 60104  | beige   | 7 mm   | 1000     | 0,0320 | 601045  |



### LÁGRIMA ADHESIVA

Adhesive tear

| código | acabado      | medida   | embalaje | precio | 8431488 |
|--------|--------------|----------|----------|--------|---------|
| Nº     |              |          |          | €      |         |
| 61921  | transparente | 7x1,5 mm | 1000     | 0,0330 | 619217  |
| 61922  | transparente | 10x3 mm  | 1000     | 0,0330 | 619224  |
| 61923  | transparente | 13x4 mm  | 1000     | 0,1090 | 619231  |



### LÁGRIMA BIMATERIAL EMBUTIR

Mortise tear bimaterial

| código | acabado      | medida     | embalaje | precio | 8431488 |
|--------|--------------|------------|----------|--------|---------|
| Nº     |              |            |          | €      |         |
| 61924  | transparente | 8,8x2,5 mm | 1000     | 0,0600 | 619248  |



(Taladro 5 mm)



### TOPE MUEBLE PUA

Top pua furniture

| código | acabado  | medida   | embalaje | precio | 8431488 |
|--------|----------|----------|----------|--------|---------|
| Nº     |          |          |          | €      |         |
| 60620  | latonado | 25x19 mm | 500      | 0,0500 | 606200  |

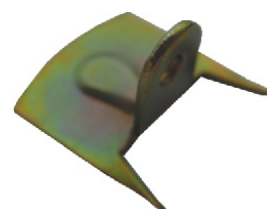

# Complementos armario y mueble

## Cabinet and furniture accesories

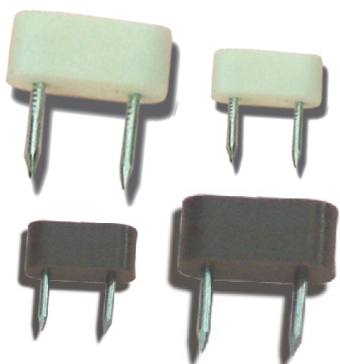

### TOPE 2 PUNTAS

Top 2 tips

| código | acabado | medida  | embalaje | precio | 8431488 |
|--------|---------|---------|----------|--------|---------|
| Nº     |         |         |          | €      |         |
| 60601  | blanco  | pequeño | 1000     | 0,0320 | 606019  |
| 60603  | blanco  | pequeño | 100      | 0,0390 | 606033  |
| 60602  | marrón  | pequeño | 1000     | 0,0320 | 606026  |
| 60604  | marrón  | pequeño | 100      | 0,0390 | 606040  |
| 60611  | blanco  | grande  | 1000     | 0,0320 | 606118  |
| 60613  | blanco  | grande  | 100      | 0,0390 | 606132  |
| 60612  | marrón  | grande  | 1000     | 0,0320 | 606125  |
| 60614  | marrón  | grande  | 100      | 0,0390 | 606149  |



### DESGLIZANTE CLAVO

Nail glide

| código | acabado | medida | embalaje | precio | 8431488 |
|--------|---------|--------|----------|--------|---------|
| Nº     |         |        |          | €      |         |
| 60511  | blanco  | 15 mm  | 1000     | 0,0240 | 605111  |
| 60503  | blanco  | 15 mm  | 100      | 0,0330 | 605036  |
| 60512  | marrón  | 15 mm  | 1000     | 0,0240 | 605128  |
| 60504  | marrón  | 15 mm  | 100      | 0,0330 | 605043  |
| 60521  | blanco  | 17 mm  | 1000     | 0,0250 | 605210  |
| 60505  | blanco  | 17 mm  | 100      | 0,0350 | 605050  |
| 60522  | marrón  | 17 mm  | 1000     | 0,0250 | 605227  |
| 60506  | marrón  | 17 mm  | 100      | 0,0350 | 605067  |
| 60501  | blanco  | 19 mm  | 1000     | 0,0270 | 605012  |
| 60507  | blanco  | 19 mm  | 100      | 0,0380 | 605074  |
| 60502  | marrón  | 19 mm  | 1000     | 0,0270 | 605029  |
| 60508  | marrón  | 19 mm  | 100      | 0,0380 | 605081  |



### DESGLIZANTE FIELTRO

Felt glide

| código | acabado | medida | embalaje | precio | 8431488 |
|--------|---------|--------|----------|--------|---------|
| Nº     |         |        |          | €      |         |
| 60536  | marrón  | 17 mm  | 500      | 0,1620 | 605364  |
| 60537  | marrón  | 20 mm  | 500      | 0,1810 | 605371  |
| 60538  | marrón  | 25 mm  | 250      | 0,2340 | 605388  |
| 60539  | marrón  | 30 mm  | 200      | 0,2920 | 605395  |



### DESGLIZANTE METÁLICO

Metal glide

| código | acabado | medida | embalaje | precio | 8431488 |
|--------|---------|--------|----------|--------|---------|
| Nº     |         |        |          | €      |         |
| 60531  | níquel  | 15 mm  | 500      | 0,1720 | 605319  |
| 60532  | níquel  | 18 mm  | 500      | 0,1860 | 605326  |
| 60533  | níquel  | 20 mm  | 350      | 0,2075 | 605333  |
| 60534  | níquel  | 23 mm  | 250      | 0,2400 | 605340  |
| 60535  | níquel  | 26 mm  | 150      | 0,3390 | 605357  |