



# CATÁLOGO 2011

MADE IN SPAIN

# UBICACIÓN

Situada en Aretxabaleta. Dentro de la comarca guipuzcoana del Alto Deba. Un núcleo industrial referente con una destacada experiencia en innovación de producto y perfectamente comunicada con el resto de la península y Europa.



La concentración en un mismo espacio físico de oficinas comerciales, técnicas, producción y almacenamiento se traduce en mayor coordinación, eficacia y rapidez de respuesta.

# experiencia y futuro

Más de 70 años en el mundo de la cerrajería nos proporcionan un control del medio, de las redes de distribución y de las necesidades del cliente. Pero sobre todo nos ha permitido entender que era el momento de dar un paso hacia adelante.





## ÍNDICE POR REFERENCIA

REF.	PÁG	REF.	PÁG	REF.	PÁG	REF.	PÁG
3001	160	11A/3P	77	156A70D/1	86	184A38/6AN	21
13718000	169	11B	79	156A70I/0	86	184C23/6	21
13718000	170	11B/M	79	156A70I/1	86	184C23/6AN	21
14154000	169	11E	78	156B60D/0	87	184C25/6	21
14154000	169	122A70D/0	92	156B60D/1	87	184C25/6AN	21
1122A70D/0	92	122A70D/1	92	156B60I/0	87	184C28/6	21
1122A70D/1	92	122A70I/0	92	156B60I/1	87	184C28/6AN	21
1122A70I/0	92	122A70I/1	92	156BR70D/0	87	184C30/6	21
1122A70I/1	92	122C70D/0	93	156BR70D/1	87	184C30/6AN	21
1122C70D/0	93	122C70D/1	93	156BR70I/0	87	184C33/6	21
1122C70D/1	93	122C70I/0	93	156BR70I/1	87	184C33/6AN	21
1122C70I/0	93	122C70I/1	93	156C60D/0	88	184C35/6	21
1122C70I/1	93	123A10D/0	94	156C60D/1	88	184C35/6AN	21
1123A10D/0	94	123A10D/1	94	156C60I/0	88	184C38/6	21
1123A10D/1	94	123A10I/0	94	156C60I/1	88	184C38/6AN	21
1123A10I/0	94	123A10I/1	94	156C70D/0	88	184V23/6	22
1123A10I/1	94	123A12D/0	94	156C70D/1	88	184V23/6AN	22
1123A12D/0	94	123A12D/1	94	156C70I/0	88	184V25/6	22
1123A12D/1	94	123A12I/0	94	156C70I/1	88	184V25/6AN	22
1123A12I/0	94	123A12I/1	94	184/23/0	20	184V28/6	22
1123A12I/1	94	123C10D/0	95	184/23/0AN	20	184V28/6AN	22
1123C10D/0	95	123C10D/1	95	184/23/6	20	184V30/6	22
1123C10D/1	95	123C10I/0	95	184/23/6AN	20	184V30/6AN	22
1123C10I/0	95	123C10I/1	95	184/25/0	20	184V33/6	22
1123C10I/1	95	123C12D/0	95	184/25/0AN	20	184V33/6AN	22
1123C12D/0	95	123C12D/1	95	184/25/6	20	184V35/6	22
1123C12D/1	95	123C12I/0	95	184/25/6AN	20	184V35/6AN	22
1123C12I/0	95	123C12I/1	95	184/28/0	20	184V38/6	22
1123C12I/1	95	124A10D/0	91	184/28/0AN	20	184V38/6AN	22
1124A10D/0	91	124A10D/1	91	184/28/6	20	190/23/0	56
1124A10D/1	91	124A10I/0	91	184/28/6AN	20	190/23/5	56
1124A10I/0	91	124A10I/1	91	184/30/0	20	190/23/6	56
1124A10I/1	91	124A12D/0	91	184/30/0AN	20	190/28/0	56
1124A12D/0	91	124A12D/1	91	184/30/6	20	190/28/5	56
1124A12D/1	91	124A12I/0	91	184/30/6AN	20	190/28/6	56
1124A12I/0	91	124A12I/1	91	184/33/0	20	190A23/0	56
1124A12I/1	91	124A14D/0	91	184/33/0AN	20	190A23/5	56
1124A14D/0	91	124A14D/1	91	184/33/6	20	190A23/6	56
1124A14D/1	91	124A14I/0	91	184/33/6AN	20	190A28/0	56
1124A14I/0	91	124A14I/1	91	184/35/0	20	190A28/5	56
1124A14I/1	91	124A8D/0	91	184/35/0AN	20	190A28/6	56
1124A8D/0	91	124A8D/1	91	184/35/6	20	190A33/0	56
1124A8D/1	91	124A8I/0	91	184/35/6AN	20	190A33/5	56
1124A8I/0	91	124A8I/1	91	184/38/0	20	190A33/6	56
1124A8I/1	91	125A12D/0	89	184/38/0AN	20	192/25/6	34
1125A12D/0	89	125A12D/1	89	184/38/6	20	192/25/6AN	34
1125A12D/1	89	125A12I/0	89	184/38/6AN	20	192/30/6	34
1125A12I/0	89	125A12I/1	89	184A23/0	21	192/30/6AN	34
1125A12I/1	89	125A14D/0	89	184A23/0AN	21	192/35/6	34
1125A14D/0	89	125A14D/1	89	184A23/6	21	192/35/6AN	34
1125A14D/1	89	125A14I/0	89	184A23/6AN	21	192V25/6	34
1125A14I/0	89	125A14I/1	89	184A25/0	21	192V25/6AN	34
1125A14I/1	89	125A8D/0	89	184A25/0AN	21	192V30/6	34
1125A8D/0	89	125A8D/1	89	184A25/6	21	192V30/6AN	34
1125A8D/1	89	125A8I/0	89	184A25/6AN	21	192V35/6	34
1125A8I/0	89	125A8I/1	89	184A28/0	21	192V35/6AN	34
1125A8I/1	89	125AR10D/0	89	184A28/0AN	21	194/25/6	35
1125AR10D/0	89	125AR10D/1	89	184A28/6	21	194/25/6AN	35
1125AR10D/1	89	125AR10I/0	89	184A28/6AN	21	194/25/6U	35
1125AR10I/0	89	125AR10I/1	89	184A30/0	21	194/30/6	35
1125AR10I/1	89	125BR12D/0	90	184A30/0AN	21	194/30/6AN	35
1125BR12D/0	90	125BR12D/1	90	184A30/6	21	194/30/6U	35
1125BR12D/1	90	125BR12I/0	90	184A30/6AN	21	194/35/6	35
1125BR12I/0	90	125BR12I/1	90	184A33/0	21	194/35/6AN	35
1125BR12I/1	90	125BR14D/0	90	184A33/0AN	21	194/35/6U	35
1125BR14D/0	90	125BR14D/1	90	184A33/6	21	194C25/6	35
1125BR14D/1	90	125BR14I/0	90	184A33/6AN	21	194C25/6AN	35
1125BR14I/0	90	125BR14I/1	90	184A35/0	21	194C25/6U	35
1125BR14I/1	90	1404X000-Y	170	184A35/0AN	21	194C30/6	35
11981/60/0	72	156A60D/0	86	184A35/6	21	194C30/6AN	35
11981/60/5	72	156A60D/1	86	184A35/6AN	21	194C30/6U	35
11981V60/0	72	156A60I/0	86	184A38/0	21	194C35/6	35
11981V60/5	72	156A60I/1	86	184A38/0AN	21	194C35/6AN	35
11A	77	156A70D/0	86	184A38/6	21	194C35/6U	35

**ÍNDICE POR REFERENCIA**

REF.	PÁG	REF.	PÁG	REF.	PÁG	REF.	PÁG
194T25/6	36	1964C/6	70	196T35/6	25	1981V60/5	72
194T25/6AN	36	1964CP/6	70	196T35/6AN	25	1982/0	75
194T25/6U	36	1964R/0	71	196T35/6U	25	1982/5	75
194T30/6	36	1964RV/0	71	196T38/6	25	1983/20/0	65
194T30/6AN	36	1964T/0	71	196T38/6AN	25	1983/20/5	65
194T30/6U	36	1964T/5	71	196V25/6	26	1983/20/6	65
194T35/6	36	1964T/6	71	196V25/6AN	26	1983/25/0	65
194T35/6AN	36	1964V/0	71	196V25/6U	26	1983/25/5	65
194T35/6U	36	1964V/5	71	196V28/6	26	1983/25/6	65
194V25/6	36	1964V/6	71	196V28/6AN	26	1983/30/0	65
194V25/6AN	36	1968/0	74	196V30/6	26	1983/30/5	65
194V25/6U	36	1968/5	74	196V30/6AN	26	1983/30/6	65
194V30/6	36	196A25/6	24	196V30/6U	26	1983A20/0	65
194V30/6AN	36	196A25/6AN	24	196V33/6	26	1983A20/5	65
194V30/6U	36	196A25/6U	24	196V33/6AN	26	1983A25/0	65
194V35/6	36	196A28/6	24	196V35/6	26	1983A25/5	65
194V35/6AN	36	196A28/6AN	24	196V35/6AN	26	1983A30/0	65
194V35/6U	36	196A30/6	24	196V35/6U	26	1983A30/5	65
196/25/6	23	196A30/6AN	24	196V38/6	26	1983C20/6	65
196/25/6AN	23	196A30/6U	24	196V38/6AN	26	1983C25/6	65
196/25/6U	23	196A33/6	24	197/25/6	27	1983C30/6	65
196/28/6	23	196A33/6AN	24	197/28/6	27	1983R20/0	66
196/28/6AN	23	196A35/6	24	197/30/6	27	1983R25/0	66
196/30/6	23	196A35/6AN	24	197/33/6	27	1983R30/0	66
196/30/6AN	23	196A35/6U	24	197/35/6	27	1983RV/0	66
196/30/6U	23	196A38/6	24	197/38/6	27	1983T20/6	66
196/33/6	23	196A38/6AN	24	1970/40/2	108	1983T25/6	66
196/33/6AN	23	196C25/6	24	1970/40/6	108	1983T30/6	66
196/35/6	23	196C25/6AN	24	1970/50/2	108	1984/20/0	52
196/35/6AN	23	196C25/6U	24	1970/50/6	108	1984/20/5	52
196/35/6U	23	196C28/6	24	1970/60/2	108	1984/20/6	52
196/38/6	23	196C28/6AN	24	1970/60/6	108	1984/25/0	52
196/38/6AN	23	196C30/6	24	1970A40/2	108	1984/25/5	52
1960/60/2	110	196C30/6AN	24	1970A40/6	108	1984/25/6	52
1960/60/6	110	196C30/6U	24	1970A50/2	108	1984/30/0	52
1960/70/2	110	196C33/6	24	1970A50/6	108	1984/30/5	52
1960/70/6	110	196C33/6AN	24	1970A60/2	108	1984/30/6	52
1960A60/2	110	196C35/6	24	1970A60/6	108	1984C20/6	52
1960A60/6	110	196C35/6AN	24	1970T40/2	108	1984C25/6	52
1960A70/2	110	196C35/6U	24	1970T40/6	108	1984C30/6	52
1960A70/6	110	196C38/6	24	1970T50/2	108	1984T20/6	53
1960T60/2	110	196C38/6AN	24	1970T50/6	108	1984T25/6	53
1960T60/6	110	196R23/6	25	1970T60/2	108	1984T30/6	53
1960T70/2	110	196R23/6AN	25	1970T60/6	108	1984V20/6	53
1960T70/6	110	196R25/6	25	1970V40/2	109	1984V25/6	53
1961/60/2	111	196R25/6AN	25	1970V40/6	109	1984V30/6	53
1961/70/2	111	196R25/6U	25	1970V50/2	109	1985/3P/2	107
1961A60/2	111	196R28/6	25	1970V50/6	109	1985/40/2	107
1961A70/2	111	196R28/6AN	25	1970V60/2	109	1985/40/6	107
1962/60/2	112	196R30/6	25	1970V60/6	109	1985/50/2	107
1962/70/2	112	196R30/6AN	25	1975/0	69	1985/50/6	107
1962A60/2	112	196R30/6U	25	1975/5	69	1985/60/2	107
1962A70/2	112	196R33/6	25	1975A/0	69	1985/60/6	107
1962T60/2	112	196R33/6AN	25	1975A/5	69	1985T40/2	107
1962T70/2	112	196R35/6	25	1975T/0	69	1985T40/6	107
1963/0	67	196R35/6AN	25	1975T/5	69	1985T50/2	107
1963/5	67	196R35/6U	25	1975V/0	69	1985T50/6	107
1963/6	67	196R38/6	25	1975V/5	69	1985T60/2	107
1963A/0	67	196R38/6AN	25	1976/1	96	1985T60/6	107
1963A/5	67	196RV/6	26	1978/0	97	1988/0	98
1963A/6	67	196RV/6AN	26	1978/1	97	1988/1	98
1963C/6	67	196RV/6U	26	1979/0	76	1990/20/0	57
1963CP16/6	68	196T23/6	25	1979/5	76	1990/20/5	57
1963R/0	68	196T23/6AN	25	1979P/0	76	1990/20/6	57
1963RV/0	68	196T25/6	25	1979P/5	76	1990/25/0	57
1963V/0	68	196T25/6AN	25	197K25/6	27	1990/25/5	57
1963V/5	68	196T25/6U	25	197K28/6	27	1990/25/6	57
1963V/6	68	196T28/6	25	197K30/6	27	1990/32/0	57
1964/0	70	196T28/6AN	25	197K33/6	27	1990/32/5	57
1964/5	70	196T30/6	25	197K35/6	27	1990/32/6	57
1964/6	70	196T30/6AN	25	197K38/6	27	1990A20/0	57
1964A/0	70	196T30/6U	25	1981/60/0	72	1990A20/5	57
1964A/5	70	196T33/6	25	1981/60/5	72	1990A20/6	57
1964C/0	70	196T33/6AN	25	1981V60/0	72	1990A25/0	57

## ÍNDICE POR REFERENCIA

REF.	PÁG	REF.	PÁG	REF.	PÁG	REF.	PÁG
1990A25/5	57	1E5/40/6AN	12	296/33/6L	28	2E5/35/6LAN	13
1990A25/6	57	1E5/40/6U	12	296/33/6LAN	28	2E5/35/6U	13
1990A32/0	57	1E5/45/6	12	296/35/6L	28	2E5/40/6L	13
1990A32/5	57	1E5/45/6AN	12	296/35/6LAN	28	2E5/40/6LAN	13
1990A32/6	57	1E5/45/6U	12	296/35/6U	28	2E5/40/6U	13
1990V20/0	57	1E5/50/6	12	296/38/6L	28	2E5/45/6L	13
1990V20/5	57	1E5/50/6AN	12	296/38/6LAN	28	2E5/45/6LAN	13
1990V20/6	57	1E5/50/6U	12	296A25/6L	29	2E5/45/6U	13
1990V25/0	57	1K5/30/6	16	296A25/6LAN	29	2E5/50/6L	13
1990V25/5	57	1K5/30/6AN	16	296A25/6U	29	2E5/50/6LAN	13
1990V25/6	57	1K5/30/6U	16	296A28/6L	29	2E5/50/6U	13
1990V32/0	57	1K5/33/6	16	296A28/6LAN	29	2K5/30/6L	17
1990V32/5	57	1K5/33/6AN	16	296A30/6L	29	2K5/30/6LAN	17
1990V32/6	57	1K5/35/6	16	296A30/6LAN	29	2K5/30/6U	17
1991/60/0	73	1K5/35/6AN	16	296A30/6U	29	2K5/33/6L	17
1991/60/5	73	1K5/35/6U	16	296A33/6L	29	2K5/33/6LAN	17
1991/70/0	73	202/30/6L	18	296A33/6LAN	29	2K5/35/6L	17
1991/70/5	73	202/30/6LAN	18	296A35/6L	29	2K5/35/6LAN	17
1992/20/6	64	202/30/6U	18	296A35/6LAN	29	2K5/35/6U	17
1992/25/6	64	202/33/6L	18	296A35/6U	29	3000AD	160
1992/30/6	64	202/33/6LAN	18	296A38/6L	29	3000AI	160
1992C20/6	64	202/33/6U	18	296A38/6LAN	29	3000D	159
1992C25/6	64	202/35/6L	18	296V25/6L	29	3000I	159
1992C30/6	64	202/35/6LAN	18	296V25/6LAN	29	3005/6	159
1992T20/6	64	202/35/6U	18	296V25/6U	29	302/30/6L	19
1992T25/6	64	234/50/1	99	296V28/6L	29	302/30/6LAN	19
1992T30/6	64	234/60/1	99	296V28/6LAN	29	302/30/6U	19
1994/25/6	58	234/70/1	99	296V30/6L	29	302/33/6L	19
1994/25/6L	58	236/50/1	100	296V30/6LAN	29	302/33/6LAN	19
1994/30/6	58	236/60/1	100	296V30/6U	29	302/33/6U	19
1994/30/6L	58	236/70/1	100	296V33/6L	29	302/35/6L	19
1994/35/6	58	249B50/2	116	296V33/6LAN	29	302/35/6LAN	19
1994/35/6L	58	249B60/2	116	296V35/6L	29	302/35/6U	19
1994A25/6	59	249C50/2	116	296V35/6LAN	29	3994/25/6	62
1994A25/6L	59	249C60/2	116	296V35/6U	29	3994/25/6L	62
1994A30/6	59	249C70/2	116	296V38/6L	29	3994/30/6	62
1994A30/6L	59	249R50/2	116	296V38/6LAN	29	3994/30/6L	62
1994A35/6	59	249R60/2	116	2994/25/6	60	3994/35/6	62
1994A35/6L	59	249R70/2	116	2994/25/6L	60	3994/35/6L	62
1994V25/6	59	294/25/6L	37	2994/30/6	60	3994A25/6	62
1994V25/6L	59	294/25/6LAN	37	2994/30/6L	60	3994A25/6L	62
1994V30/6	59	294/25/6U	37	2994/35/6	60	3994A30/6	62
1994V30/6L	59	294/30/6L	37	2994/35/6L	60	3994A30/6L	62
1994V35/6	59	294/30/6LAN	37	2994A25/6	61	3994A35/6	62
1994V35/6L	59	294/30/6U	37	2994A25/6L	61	3994A35/6L	62
1995/32/0	54	294/35/6L	37	2994A30/6	61	3994F25/6	63
1995/32/5	54	294/35/6LAN	37	2994A30/6L	61	3994F25/6L	63
1995/32/6	54	294/35/6U	37	2994A35/6	61	3994F30/6	63
1995A32/6	54	294A25/6L	38	2994A35/6L	61	3994F30/6L	63
1995R32/0	54	294A25/6U	38	2994V25/6	61	3994F35/6	63
1995T32/6	55	294A25/L6AN	38	2994V25/6L	61	3994F35/6L	63
1995V32/6	55	294A30/6L	38	2994V30/6	61	3994V25/6	63
1E2/30/6	14	294A30/6U	38	2994V30/6L	61	3994V25/6L	63
1E2/30/6AN	14	294A30/L6AN	38	2994V35/6	61	3994V30/6	63
1E2/30/6U	14	294A35/6L	38	2994V35/6L	61	3994V30/6L	63
1E2/35/6	14	294A35/6U	38	2E2/30/6L	15	3994V35/6	63
1E2/35/6AN	14	294A35/L6AN	38	2E2/30/6LAN	15	3994V35/6L	63
1E2/35/6U	14	294V25/6L	38	2E2/30/6U	15	400/50/6HP	154
1E2/40/6	14	294V25/6LAN	38	2E2/35/6L	15	400/60/6HP	154
1E2/40/6AN	14	294V25/6U	38	2E2/35/6LAN	15	4000/50/2ZB	104
1E2/40/6U	14	294V30/6L	38	2E2/35/6U	15	4000/50/6ZB	104
1E2/45/6	14	294V30/6LAN	38	2E2/40/6L	15	4000/60/2ZB	104
1E2/45/6AN	14	294V30/6U	38	2E2/40/6LAN	15	4000/60/6ZB	104
1E2/45/6U	14	294V35/6L	38	2E2/40/6U	15	4000A50/2ZB	104
1E2/50/6	14	294V35/6LAN	38	2E2/45/6L	15	4000A50/6ZB	104
1E2/50/6AN	14	294V35/6U	38	2E2/45/6LAN	15	4000A60/2ZB	104
1E2/50/6U	14	296/25/6L	28	2E2/45/6U	15	4000A60/6ZB	104
1E5/30/6	12	296/25/6LAN	28	2E2/50/6L	15	4001/50/2ZB	104
1E5/30/6AN	12	296/25/6U	28	2E2/50/6LAN	15	4001/50/6ZB	104
1E5/30/6U	12	296/28/6L	28	2E2/50/6U	15	4001/60/2ZB	104
1E5/35/6	12	296/28/6LAN	28	2E5/30/6L	13	4001/60/6ZB	104
1E5/35/6AN	12	296/30/6L	28	2E5/30/6LAN	13	4001A50/2ZB	104
1E5/35/6U	12	296/30/6LAN	28	2E5/30/6U	13	4001A50/6ZB	104
1E5/40/6	12	296/30/6U	28	2E5/35/6L	13	4001A60/2ZB	104

## ÍNDICE POR REFERENCIA

REF.	PÁG	REF.	PÁG	REF.	PÁG	REF.	PÁG
4001A60/6ZB	104	496/35/6U	30	5961/2525/3	144	5982/2545/4	128
400L60/6HP	154	496/38/6L	30	5961/2525/4	144	5982/2550/3	128
400LT60/6H	155	496/38/6LAN	30	5961/3030/3	144	5982/2550/4	128
400T50/6H	155	496A25/6L	31	5961/3030/4	144	5982/2555/3	128
400T60/6H	155	496A25/6LAN	31	5962/2525/3	145	5982/2555/4	128
401/50/6HP	154	496A25/6U	31	5962/3030/3	145	5982/2560/3	128
401/60/6HP	154	496A28/6L	31	5962/4040/3	145	5982/2560/4	128
401L60/6HP	154	496A28/6LAN	31	5962T30/3	145	5982/2565/3	128
401LT60/6H	155	496A30/6L	31	5962T40/3	145	5982/2565/4	128
401T50/6H	155	496A30/6LAN	31	5963/2222/3	142	5982/2575/3	129
401T60/6H	155	496A30/6U	31	5963/2222/4	142	5982/2575/4	129
410/50/6HP	158	496A33/6L	31	5963/2525/3	142	5982/2585/3	129
410/50D/6HP	157	496A33/6LAN	31	5963/2525/4	142	5982/2585/4	129
410/50I/6HP	157	496A35/6L	31	5963/3030/3	142	5982/2595/3	129
410/60/6HP	158	496A35/6LAN	31	5963/3030/4	142	5982/2595/4	129
410/60D/6HP	157	496A35/6U	31	5963/3535/3	142	5982/3030/3	128
410/60I/6HP	157	496A38/6L	31	5963/3535/4	142	5982/3030/4	128
4100/50/2	105	496A38/6LAN	31	5963/4040/3	142	5982/3035/3	128
4100/60/2	105	496V25/6L	31	5963/4040/4	142	5982/3035/4	128
410L60/6HP	157	496V25/6LAN	31	5963T36/3	142	5982/3040/3	128
410L60D/6HP	156	496V25/6U	31	5963T36/4	142	5982/3040/4	128
410L60I/6HP	156	496V28/6L	31	5964/2525/3	146	5982/3045/3	128
411/50/6HP	158	496V28/6LAN	31	5964/2525/4	146	5982/3045/4	128
411/50D/6HP	157	496V30/6L	31	5964/3030/3	146	5982/3050/3	128
411/50I/6HP	157	496V30/6LAN	31	5964/3030/4	146	5982/3050/4	128
411/60/6HP	158	496V30/6U	31	5964/4040/3	146	5982/3055/3	128
411/60D/6HP	157	496V33/6L	31	5964/4040/4	146	5982/3055/4	128
411/60I/6HP	157	496V33/6LAN	31	5964P3030/3	146	5982/3060/3	128
4110/50D/2	106	496V35/6L	31	5964P3030/4	146	5982/3060/4	128
4110/50I/2	106	496V35/6LAN	31	5964T25/3	146	5982/3080/3	129
4110/60D/2	106	496V35/6U	31	5964T25/4	146	5982/3080/4	129
4110/60I/2	106	496V38/6L	31	5964T30/3	146	5982/3535/3	128
411L60/6HP	157	496V38/6LAN	31	5964T30/4	146	5982/3535/4	128
411L60D/6HP	156	5000/1N	151	5964T40/3	146	5982/3540/3	128
411L60I/6HP	156	5000/1NM	151	5964T40/4	146	5982/3540/4	128
494/25/6L	39	5000/6	151	5968/2525/3	147	5982/3545/3	128
494/25/6LAN	39	5081/3030/3	143	5968/2525/4	147	5982/3545/4	128
494/25/6U	39	5081/3030/4	143	5968/3030/3	147	5982/3555/3	128
494/30/6L	39	5181/3030/3	143	5968/3030/4	147	5982/3555/4	128
494/30/6LAN	39	5181/3030/4	143	5968/4040/3	147	5982/3565/3	129
494/30/6U	39	5500/1N	152	5968/4040/4	147	5982/3565/4	129
494/35/6L	39	5500/1NM	152	5968P3030/3	147	5982/3575/3	129
494/35/6LAN	39	5500/6	152	5968P3030/4	147	5982/3575/4	129
494/35/6U	39	5500/6E	152	5968T25/3	147	5982/3595/3	129
494A25/6L	40	56A60D/0	86	5968T25/4	147	5982/3595/4	129
494A25/6LAN	40	56A60D/1	86	5968T30/3	147	5982/4040/3	128
494A25/6U	40	56A60I/0	86	5968T30/4	147	5982/4040/4	128
494A30/6L	40	56A60I/1	86	5968T40/3	147	5982/4050/3	129
494A30/6LAN	40	56A70D/0	86	5968T40/4	147	5982/4050/4	129
494A30/6U	40	56A70D/1	86	596A25/6L	33	5982/4055/3	129
494A35/6L	40	56A70I/0	86	596A28/6L	33	5982/4055/4	129
494A35/6LAN	40	56A70I/1	86	596A30/6L	33	5982/4060/3	129
494A35/6U	40	56B60D/0	87	596A33/6L	33	5982/4060/4	129
494V25/6L	40	56B60D/1	87	596A35/6L	33	5982/4070/3	129
494V25/6LAN	40	56B60I/0	87	596A38/6L	33	5982/4070/4	129
494V25/6U	40	56B60I/1	87	596V25/6L	33	5982/4080/3	129
494V30/6L	40	56BR70D/0	87	596V28/6L	33	5982/4080/4	129
494V30/6LAN	40	56BR70D/1	87	596V30/6L	33	5982/4545/3	129
494V30/6U	40	56BR70I/0	87	596V33/6L	33	5982/4545/4	129
494V35/6L	40	56BR70I/1	87	596V35/6L	33	5982/4555/3	129
494V35/6LAN	40	56C60D/0	88	596V38/6L	33	5982/4555/4	129
494V35/6U	40	56C60D/1	88	5979/3030/3	148	5982/5050/3	129
496/25/6L	30	56C60I/0	88	5979/3030/4	148	5982/5050/4	129
496/25/6LAN	30	56C60I/1	88	5979P3030/3	148	5982/5555/3	129
496/25/6U	30	56C70D/0	88	5979P3030/4	148	5982/5555/4	129
496/28/6L	30	56C70D/1	88	5982/2525/3	128	5982/6060/3	129
496/28/6LAN	30	56C70I/0	88	5982/2525/4	128	5982/6060/4	129
496/30/6L	30	56C70I/1	88	5982/2530/3	128	5982/6565/3	129
496/30/6LAN	30	596/25/6L	32	5982/2530/4	128	5982/6565/4	129
496/30/6U	30	596/28/6L	32	5982/2535/3	128	5982/7070/3	129
496/33/6L	30	596/30/6L	32	5982/2535/4	128	5982/7070/4	129
496/33/6LAN	30	596/33/6L	32	5982/2540/3	128	5982/7575/3	129
496/33/6U	30	596/35/6L	32	5982/2540/4	128	5982/7575/4	129
496/35/6LAN	30	596/38/6L	32	5982/2545/3	128	5982P2525/3	130



## ÍNDICE POR REFERENCIA

REF.	PÁG	REF.	PÁG	REF.	PÁG	REF.	PÁG
5982P2525/4	130	5990/2555/4	132	5990P2535/4	134	6968T30/3	147
5982P2530/3	130	5990/2560/3	132	5990P2540/3	134	6968T30/4	147
5982P2530/4	130	5990/2560/4	132	5990P2540/4	134	6982/2525/3	136
5982P2535/3	130	5990/2565/3	132	5990P2545/3	134	6982/2525/4	136
5982P2535/4	130	5990/2565/4	132	5990P2545/4	134	6982/2530/3	136
5982P2540/3	130	5990/2575/3	133	5990P2550/3	134	6982/2530/4	136
5982P2540/4	130	5990/2575/4	133	5990P2550/4	134	6982/2535/3	136
5982P2545/3	130	5990/2585/3	133	5990P2555/3	134	6982/2535/4	136
5982P2545/4	130	5990/2585/4	133	5990P2555/4	134	6982/2540/3	136
5982P2550/3	130	5990/2595/3	133	5990P2560/3	134	6982/2540/4	136
5982P2550/4	130	5990/2595/4	133	5990P2560/4	134	6982/2545/3	136
5982P2555/3	130	5990/3030/3	132	5990P2565/3	134	6982/2545/4	136
5982P2555/4	130	5990/3030/4	132	5990P2565/4	134	6982/2550/3	136
5982P2560/3	130	5990/3035/3	132	5990P25725/3	135	6982/2550/4	136
5982P2560/4	130	5990/3035/4	132	5990P25725/4	135	6982/2555/3	136
5982P2565/3	130	5990/3040/3	132	5990P3030/3	134	6982/2555/4	136
5982P2565/4	130	5990/3040/4	132	5990P3030/4	134	6982/2560/3	136
5982P25725/3	131	5990/3045/3	132	5990P3045/3	134	6982/2560/4	136
5982P25725/4	131	5990/3045/4	132	5990P3045/4	134	6982/2565/3	137
5982P3030/3	130	5990/3050/3	132	5990P30730/3	135	6982/2565/4	137
5982P3030/4	130	5990/3050/4	132	5990P30730/4	135	6982/2575/3	137
5982P3045/3	130	5990/3055/3	132	5990P30745/3	135	6982/2575/4	137
5982P3045/4	130	5990/3055/4	132	5990P30745/4	135	6982/2585/3	137
5982P30730/3	131	5990/3060/3	133	5990P3525/3	134	6982/2585/4	137
5982P30730/4	131	5990/3060/4	133	5990P3525/4	134	6982/2595/3	137
5982P30745/3	131	5990/3080/3	133	5990P3535/3	134	6982/2595/4	137
5982P30745/4	131	5990/3080/4	133	5990P3535/4	134	6982/3030/3	136
5982P3525/3	130	5990/3535/3	132	5990P3540/3	134	6982/3030/4	136
5982P3525/4	130	5990/3535/4	132	5990P3540/4	134	6982/3035/3	136
5982P3535/3	130	5990/3540/3	132	5990P3545/3	134	6982/3035/4	136
5982P3535/4	130	5990/3540/4	132	5990P3545/4	134	6982/3040/3	136
5982P3540/3	130	5990/3545/3	132	5990P35725/3	135	6982/3040/4	136
5982P3540/4	130	5990/3545/4	132	5990P35725/4	135	6982/3045/3	136
5982P3545/3	130	5990/3555/3	133	5990P35735/3	135	6982/3045/4	136
5982P3545/4	130	5990/3555/4	133	5990P35735/4	135	6982/3050/3	136
5982P35725/3	131	5990/3565/3	133	5990PT25/45/4	135	6982/3050/4	136
5982P35725/4	131	5990/3565/4	133	5990PT2505/3	134	6982/3055/3	136
5982P35735/3	131	5990/3575/3	133	5990PT2505/4	134	6982/3055/4	136
5982P35735/4	131	5990/3575/4	133	5990PT2525/3	135	6982/3060/3	137
5982PT2505/3	130	5990/3595/3	133	5990PT2525/4	135	6982/3060/4	137
5982PT2505/4	130	5990/3595/4	133	5990PT2535/3	135	6982/3535/3	136
5982PT2525/3	131	5990/4040/3	132	5990PT2535/4	135	6982/3535/4	136
5982PT2525/4	131	5990/4040/4	132	5990PT2545/3	135	6982/3540/3	136
5982PT2535/3	131	5990/4050/3	133	5990T40/3	134	6982/3540/4	136
5982PT2535/4	131	5990/4050/4	133	5990T40/4	134	6982/3545/3	136
5982PT2545/3	131	5990/4055/3	133	5990T45/3	134	6982/3545/4	136
5982PT2545/4	131	5990/4055/4	133	5990T45/4	134	6982/3555/3	137
5982T40/3	130	5990/4060/3	133	5990T50/3	134	6982/3555/4	137
5982T40/4	130	5990/4060/4	133	5990T50/4	134	6982/3565/3	137
5982T45/3	130	5990/4070/3	133	5990T55/3	134	6982/3565/4	137
5982T45/4	130	5990/4070/4	133	5990T55/4	134	6982/4040/3	136
5982T50/3	130	5990/4080/3	133	5990T60/3	134	6982/4040/4	136
5982T50/4	130	5990/4080/4	133	5990T60/4	134	6982/4045/3	136
5982T55/3	130	5990/4545/3	133	5990T65/3	134	6982/4045/4	136
5982T55/4	130	5990/4545/4	133	5990T65/4	134	6982/4050/3	137
5982T60/3	130	5990/4555/3	133	5990T70/3	134	6982/4050/4	137
5982T60/4	130	5990/4555/4	133	5990T70/4	134	6982/4055/3	137
5982T65/3	130	5990/5050/3	133	6000D/1N	153	6982/4055/4	137
5982T65/4	130	5990/5050/4	133	6000D/1NM	153	6982/4545/3	137
5982T70/3	130	5990/5555/3	133	6000D/6	153	6982/4545/4	137
5982T70/4	130	5990/5555/4	133	6000I/1N	153	6982/4555/3	137
5990/2525/3	132	5990/6060/3	133	6000I/1NM	153	6982/4555/4	137
5990/2525/4	132	5990/6060/4	133	6000I/6	153	6982/4560/3	137
5990/2530/3	132	5990/6565/3	133	62/50/2	113	6982/4560/4	137
5990/2530/4	132	5990/6565/4	133	62/60/2	113	6982/5050/3	137
5990/2535/3	132	5990/7070/3	133	63R50/2	113	6982/5050/4	137
5990/2535/4	132	5990/7070/4	133	63R60/2	113	6982/5555/3	137
5990/2540/3	132	5990/7575/3	133	63R70/2	113	6982/5555/4	137
5990/2540/4	132	5990/7575/4	133	6964/3030/3	146	6982/6565/3	137
5990/2545/3	132	5990P2525/3	134	6964/3030/4	146	6982/6565/4	137
5990/2545/4	132	5990P2525/4	134	6964T30/3	146	6982/7070/3	137
5990/2550/3	132	5990P2530/3	134	6964T30/4	146	6982/7070/4	137
5990/2550/4	132	5990P2530/4	134	6968/3030/3	147	6982/7575/3	137
5990/2555/3	132	5990P2535/3	134	6968/3030/4	147	6982/7575/4	137



## ÍNDICE POR REFERENCIA

REF.	PÁG	REF.	PÁG	REF.	PÁG	REF.	PÁG
6982P2525/3	138	6990/3555/3	140	BAR5000/6	165	CE4001/2	117
6982P2525/4	138	6990/3555/4	140	BAR5000/6E	165	CE4001/6	117
6982P2535/3	138	6990/3565/3	140	BTI296/1N	49	CE5000/6	165
6982P2535/4	138	6990/3565/4	140	BTI296/1NM	49	CE5000/1N	165
6982P2545/3	138	6990/4040/3	139	BTI296/1PL	49	CE942C30/2	119
6982P2545/4	138	6990/4040/4	139	BTI94/1N	49	CE942C35/2	119
6982P2555/3	138	6990/4045/3	139	BTI94/1N	84	CE942R25/2	118
6982P2555/4	138	6990/4045/4	139	BTI94/1NM	49	CE942R30/2	118
6982P3030/3	138	6990/4050/3	140	BTI94/1NM	84	CE942R30/7	118
6982P3030/4	138	6990/4050/4	140	BTI94/1PL	49	CE942R35/2	118
6982P3525/3	138	6990/4055/3	140	BTI94/1PL	84	CE942R35/7	118
6982P3525/4	138	6990/4055/4	140	CE184/OL	41	CEB6000	165
6982P3535/3	138	6990/4545/3	140	CE184/OLAN	41	CEB6000/1N	165
6982P3535/4	138	6990/4545/4	140	CE184/1N	41	CELC125/1A	101
6982P3545/3	138	6990/4555/3	140	CE184/1NR	41	CELC125/1BA	101
6982P3545/4	138	6990/4555/4	140	CE184/1NRS	41	CELC45/6A	83
6982P3555/3	138	6990/4560/3	140	CE184/6L	41	CELC45/6AD	83
6982P3555/4	138	6990/4560/4	140	CE184/6LAN	41	CELC45T/6A	83
6982P3565/3	138	6990/5050/3	140	CE184/6U	41	CELC45T/6AD	83
6982P3565/4	138	6990/5050/4	140	CE190/0	80	CELC56/1A	101
6982P4525/3	138	6990/5555/3	140	CE190/6	80	CELC56/1BA	101
6982P4525/4	138	6990/5555/4	140	CE196/1N	42	CEP202N/8D	125
6982T40/3	138	6990/6565/3	140	CE196/1NR	43	CEP202N/8I	125
6982T40/4	138	6990/6565/4	140	CE196/1NRS	43	CM5005/55/6C	163
6982T50/3	138	6990/7070/3	140	CE196/6L	42	CM5005/55/6R	163
6982T50/4	138	6990/7070/4	140	CE196/6LAN	42	CM5005/72/6C	163
6982T60/3	138	6990/7575/3	140	CE196/6LR	42	CM5005/72/6R	163
6982T60/4	138	6990/7575/4	140	CE196/6RU	42	CM5005/85/6C	163
6982T70/3	138	6990P2525/3	141	CE196/6U	42	CM5005/85/6R	163
6982T70/4	138	6990P2525/4	141	CE1960/2	118	CM5006/55/6C	162
6990/2525/3	139	6990P2535/3	141	CE1960/6	118	CM5006/55/6R	162
6990/2525/4	139	6990P2535/4	141	CE1960A/2	118	CM5006/72/6C	162
6990/2530/3	139	6990P2545/3	141	CE1960A/6	118	CM5006/72/6R	162
6990/2530/4	139	6990P2545/4	141	CE196R/6	82	CM5006/85/6C	162
6990/2535/3	139	6990P2555/3	141	CE196R/6L	44	CM5006/85/6R	162
6990/2535/4	139	6990P2555/4	141	CE196R/6LAN	44	CM5007/6C	162
6990/2540/3	139	6990P3030/3	141	CE196R/6LR	44	CM5007/6R	162
6990/2540/4	139	6990P3030/4	141	CE1970R/2	118	CM5008/55/6C	162
6990/2545/3	139	6990P3525/3	141	CE1970R/6	118	CM5008/55/6R	162
6990/2545/4	139	6990P3525/4	141	CE1983/0	80	CM5008/72/6C	163
6990/2550/3	139	6990P3535/3	141	CE1983/6	80	CM5008/72/6R	163
6990/2550/4	139	6990P3535/4	141	CE1984/0	80	CM5008/85/6C	163
6990/2555/3	139	6990P3545/3	141	CE1984/6	80	CM5008/85/6R	163
6990/2555/4	139	6990P3545/4	141	CE1985/2	117	CM5009/6C	163
6990/2560/3	139	6990P3555/3	141	CE1985/6	117	CM5009/6R	163
6990/2560/4	139	6990P3555/4	141	CE1990/0	81	CV1E5	49
6990/2565/3	140	6990P3565/3	141	CE1991/0	81	EMB196	49
6990/2565/4	140	6990P3565/4	141	CE1994/6	81	ES1960	119
6990/2575/3	140	6990P4525/3	141	CE1E5/6L	45	ES1960/4	119
6990/2575/4	140	6990P4525/4	141	CE1E5/6LR	45	ES1962	119
6990/2585/3	140	6990T40/3	141	CE202/1NR	46	ES1962/4	119
6990/2585/4	140	6990T40/4	141	CE202/1NRS	46	ES1963	84
6990/2595/3	140	6990T50/3	141	CE202/6LAN	46	ES1964	84
6990/2595/4	140	6990T50/4	141	CE202/6LR18	47	ES1964	119
6990/3030/3	139	6990T60/3	141	CE202/6LR20	47	ES1984	49
6990/3030/4	139	6990T60/4	141	CE202/6U	47	ES1984	84
6990/3035/3	139	6990T70/3	141	CE202S/1NR	46	ID1/60/6	168
6990/3035/4	139	6990T70/4	141	CE202S/1NRS	46	JES6000/6R	48
6990/3040/3	139	942R/C/2	115	CE202S/6LAN	46	JM6000/6R	48
6990/3040/4	139	942R/R/2	115	CE202S/6LR18	47	JM6006/85/6R	48
6990/3045/3	139	942RC/C/2	115	CE202S/6LR20	47	JT6006/85/6R	48
6990/3045/4	139	942RC/R/2	115	CE202S/6U	47	KCE1K5/1NR	45
6990/3050/3	139	943/2C	114	CE249R/2	118	KCE1K5/1NRS	45
6990/3050/4	139	943/2R	114	CE249R/6	118	KCE1K5/6L	45
6990/3055/3	139	943/7C	114	CE296S/1NR	44	KCE1K5/6LR	45
6990/3055/4	139	943/7R	114	CE296S/1NRS	44	KES4000	119
6990/3060/3	140	943P/2C	114	CE296S/6L	43	M5000/1N	164
6990/3060/4	140	943P/2R	114	CE296S/6LAN	43	M5001/1N	164
6990/3535/3	139	943P/7C	114	CE296S/6LR	43	M5002/1N	164
6990/3535/4	139	943P/7R	114	CE296S/6RU	44	M5003/1N	164
6990/3540/3	139	B5000	165	CE296S/6U	43	M5004/1N	164
6990/3540/4	139	B5000/4	165	CE2994S/6	82	MICRO	165
6990/3545/3	139	BAR5000/1R	165	CE4000/2	117	MICRO4000L	165
6990/3545/4	139	BAR5000/1RE	165	CE4000/6	117	P192/25/6	122

## ÍNDICE POR REFERENCIA

REF.	PÁG	REF.	PÁG	REF.	PÁG	REF.	PÁG
P192/30/6	122	P1K5/30/6	16	P2E2N/30/8	123	P302/30/6	19
P192/35/6	122	P1K5/35/6	16	P2E2N/35/8	123	P302/33/6	19
P1E2/30/6	14	P202/30/6	18	P2E2N/40/8	123	P302/35/6	19
P1E2/35/6	14	P202/33/6	18	P2E2N/45/8	123	TAP1E5	49
P1E2/40/6	14	P202/35/6	18	P2E2N/50/8	123	TUF6000/1N	165
P1E2/45/6	14	P202N/30/8	124	P2E5/30/6	13	TUF6000/1NE	165
P1E2/50/6	14	P202N/35/8	124	P2E5/35/6	13	TUF6000/6	165
P1E5/30/6	12	P2E2/30/6	15	P2E5/40/6	13	TUF6000/6E	165
P1E5/35/6	12	P2E2/35/6	15	P2E5/45/6	13	VENM1	161
P1E5/40/6	12	P2E2/40/6	15	P2E5/50/6	13	VENM2	161
P1E5/45/6	12	P2E2/45/6	15	P2K5/30/6	17	VENM3	161
P1E5/50/6	12	P2E2/50/6	15	P2K5/35/6	17	VENM554	161

### ABREVIATURAS DE ACABADOS CERRADURAS Y CILINDROS

COD.	FRENTE	CILINDRO
/0	Hierro Niquelado <b>(HN)</b>	Latón Niquelado <b>(CN)</b>
/1	Hierro Esmaltado <b>(HE)</b>	Latón Pulido <b>(LP)</b>
/2	Hierro Latonado <b>(HL)</b>	Latón Pulido <b>(LP)</b>
/3	Latón Pulido <b>(LP)</b>	Latón Pulido <b>(LP)</b>
/4	Latón Niquelado <b>(LN)</b>	Latón Niquelado <b>(CN)</b>
/5	Hierro Niquelado <b>(HN)</b>	Latón Pulido <b>(LP)</b>
/6	Acero Inoxidable <b>(AI)</b>	Latón Niquelado <b>(CN)</b>
/7	Niquel Satinado <b>(NS)</b>	Latón Niquelado <b>(CN)</b>
/8	Zincado Trivalente <b>(Z)</b>	Latón Niquelado <b>(CN)</b>

### ABREVIATURAS DE ACABADOS DE ANTIPÁNICOS Y ESCUDOS

COD.	ACABADO
/0CM	Cromo Mate
/1N	Negro
/1NM	Niquel Mate
/1PL	Plata
/2OV	Oro Viejo
/2BI	Bronce Inglés

## CERRADURAS PARA CARPINTERÍA DE ALUMINIO

	Certificado de Ensayo	10
	Palanca deslizante entre ejes 85 mm	12
	• Serie 1E5 <b>Soft</b>	12
	Multipunto palanca deslizante entre ejes 85 mm	13
	• Serie 2E5 <b>Soft</b>	13
	Palanca deslizante entre ejes 92 mm	14
	• Serie 1E2 <b>Soft</b>	14
	Multipunto palanca deslizante entre ejes 92 mm	15
	• Serie 2E2 <b>Soft</b>	15
	Palanca basculante entre ejes 85 mm	16
	• Serie 1K5 <b>DUE</b>	16
	Multipunto palanca basculante entre ejes 85 mm	17
	• Serie 2K5 <b>DUE</b>	17
	Multipunto palanca deslizante entre ejes 92 mm	18
	• Serie 202 <b>inverse</b>	18
	• Serie 302 <b>inverse</b>	19
	Palanca deslizante entre ejes 85 mm	20
	• Serie 184	20
	Palanca basculante entre ejes 85 mm	23
	• Serie 196	23
	Palanca gancho entre ejes 85 mm	27
	• Serie 197	27
	Multipunto palanca basculante entre ejes 85 mm	28
	• Serie 296	28
	Multipunto frente especial palanca basculante entre ejes 85 mm	30
	• Serie 496	30
	• Serie 596	32
	Palanca deslizante entre ejes 92 mm	34
	• Serie 192	34
	Palanca basculante entre ejes 92 mm	35
	• Serie 194	35
	Multipunto palanca basculante entre ejes 92 mm	37
	• Serie 294	37
	Multipunto frente especial palanca basculante entre ejes 92 mm	39
	• Serie 494	39
	Accesorios	41
	• Cerraderos	41
	• Escudos y manillas de acero inoxidable	48
	• Escudos	49
	• Otros	49



# Certificado de Ensayos

**EMPRESA** SISTEMAS VALLE LENIZ, S.A.

**DIRECCIÓN** Pol.Ind.Arbi-Zelai s/n  
 20550 ARETXABALETA (GIPUZKOA)

**Nº CERTIFICADO** 18146 (1/2)

## MATERIAL ENSAYADO

Cerradura de embutir con palanca deslizante de referencia:

**«192/35/6»**

- Entrada: 35
- Distancia entre ejes: 92

## ENSAYOS REALIZADOS

**Ensayos mecánicos** establecidos en la norma UNE-EN 12209:2004  
 «Herrajes en la edificación. Cerraduras, pestillos y cerraderos mecánicos.  
 Requisitos y métodos de ensayo»

## CLASIFICACIÓN

1	C	5	0	0	C	1	B	A	2	0
---	---	---	---	---	---	---	---	---	---	---

**FECHA** 18 de julio de 2008

Este documento no tiene validez sin el informe de ensayo correspondiente en el cual se indican los resultados obtenidos en cada ensayo.

Los resultados obtenidos en estos ensayos solo se refieren a la(s) muestra(s) analizada(s) en este Centro en la fecha indicada y no implican una característica de constancia en la calidad de la producción

 Fdo: Asier Maiztegi  
 Director Dpto. Construcción



<b>EMPRESA</b>	<b>SISTEMAS VALLE LENIZ, S.A.</b>
<b>DIRECCIÓN</b>	<b>Pol. Ind. Arbi-Zelai s/n 20550 ARETXABALETA (GIPUZKOA) SPAIN</b>
<b>NºCERTIFICADO</b>	<b>18146 (2/2)</b>

## ÁREA DE APLICACIÓN

La cerradura de embutir con palanca deslizante de referencia “**192/35/6**” es la combinación más desfavorable de la serie **184-192**, que consiste en varias referencias que siguen el siguiente esquema:

**192 xyy/z**

**184 xyy/z**

donde:

<b>192:</b> Distancia entre ejes	▪ 92 mm	
<b>184:</b> Distancia entre ejes	▪ 85 mm	
<b>x:</b> tipo de cerradura	▪ /: picaporte y palanca	
	▪ A: palanca	
	▪ C: muletilla	
<b>yy:</b> entrada	▪ 23	▪ 30
	▪ 25	▪ 33
	▪ 28	▪ 35
<b>Z:</b> material	▪ 0: hierro niquelado	
	▪ 6: acero inoxidable	

Por lo tanto, se deduce que la clasificación obtenida por la referencia **192/35/6** y mostrada en la página anterior puede aplicarse a todas las referencias pertenecientes a esta serie.

**FECHA** 18 de julio de 2008

Este documento no tiene validez sin el informe de ensayo correspondiente en el cual se indican los resultados obtenidos en cada ensayo.

Los resultados obtenidos en estos ensayos solo se refieren a la(s) muestra(s) analizada(s) en este Centro en la fecha indicada y no implican una característica de constancia en la calidad de la producción



Asier Maiztegi  
 Director Dpto. Construcción

## PALANCA DESLIZANTE ENTRE EJES 85 mm.

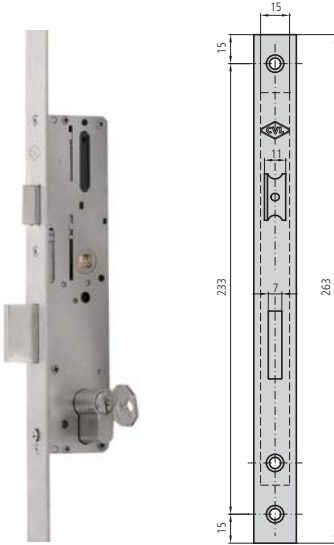
SERIE 1E5 **Soft**

## CARACTERÍSTICAS

- Máxima suavidad mediante engranajes
- Cerradura de 1 punto con frente liso inox de 16mm, 22mm, 24mm y U 24,5\*6
- Picaporte reversible y regulable de 11mm
- Mínimo stock: 3 versiones en 1 cerradura (picaporte/rodillo/sólo palanca)
- Palanca deslizante de 20mm de salida
- Diseño según norma EN 12209 Y pr. EN 15685
- Caja cerrada de 15mm
- Cuadradillo de 8mm
- 2 escudos de nylon ref. ES1984
- Tornillo de fijación de cilindro
- 2 terminales de frente de nylon ref. EMB196 para frente liso (para frente de 22 mm.)

## ACCESORIOS OPCIONALES

- Gama completa de cerraderos (ver página 41 - 47)
- Gama completa de cilindros (ver página 127 - 148)

## DESCRIPCIÓN

## REF.

MEDIDAS  
B A

## LEVA

ACABADOS  
FRENTE CILINDROUDS  
 

## PRECIO

## COMPLETA S/CILINDRO

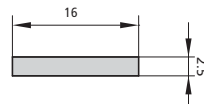

P1E5/30/6	27	43	15	Al	CN	1		
P1E5/35/6	32	48	15	Al	CN	1		
P1E5/40/6	37	53	15	Al	CN	1		
P1E5/45/6	42	58	15	Al	CN	1		
P1E5/50/6	47	63	15	Al	CN	1		

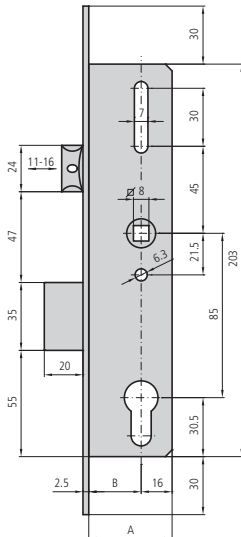

- Picaporte y palanca
- No incluye cilindro

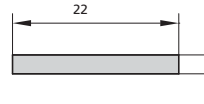
Opciones de cerradero  
(ver página 41 - 47)

1E5/30/6	27	43	15	Al	CN	1		
1E5/35/6	32	48	15	Al	CN	1		
1E5/40/6	37	53	15	Al	CN	1		
1E5/45/6	42	58	15	Al	CN	1		
1E5/50/6	47	63	15	Al	CN	1		

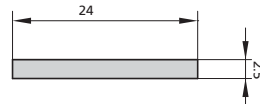

1E5/30/6AN	27	43	15	Al	CN	1		
1E5/35/6AN	32	48	15	Al	CN	1		
1E5/40/6AN	37	53	15	Al	CN	1		
1E5/45/6AN	42	58	15	Al	CN	1		
1E5/50/6AN	47	63	15	Al	CN	1		

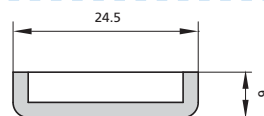

1E5/30/6U	23	39	15	Al	CN	1		
1E5/35/6U	28	44	15	Al	CN	1		
1E5/40/6U	33	49	15	Al	CN	1		
1E5/45/6U	38	54	15	Al	CN	1		
1E5/50/6U	43	59	15	Al	CN	1		

MULTIPUNTO PALANCA DESLIZANTE ENTRE EJES 85 mm.

SERIE 2E5 *Soft*

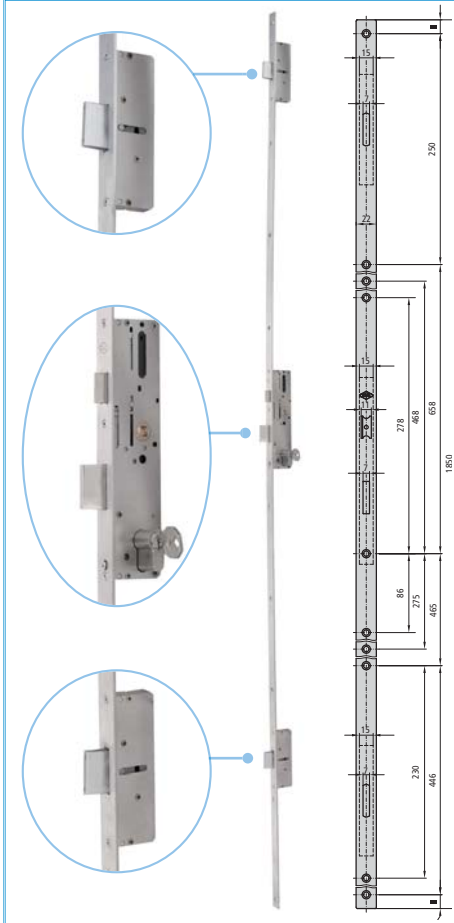

CARACTERÍSTICAS

- Máxima suavidad mediante engranajes
- Cerradura de 3 puntos con frente liso inox de 16mm, 22mm, 24mm y U 24,5\*6
- Frente de 1850mm de largo
- Picaporte reversible y regulable de 11mm
- Mínimo stock: 3 versiones en 1 cerradura (picaporte/rodillo/sólo palanca)
- Palanca deslizante de 20mm de salida
- Diseño según norma EN 12209 Y pr. EN 15685
- Caja cerrada de 15mm
- Cuadradillo de 8mm
- 2 escudos de nylon ref. ES1984
- Tornillo de fijación de cilindro

ACCESORIOS OPCIONALES

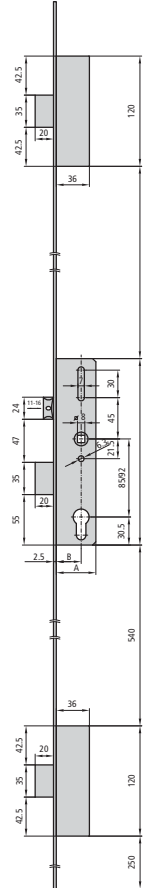

- Gama completa de cerraderos (ver página 41 - 47)
- Gama completa de cilindros (ver página 127 - 148)

DESCRIPCIÓN	REF.	MEDIDAS B A	LEVA	ACABADOS FRENTE CILINDRO	UDS  	PRECIO COMPLETA S/CILINDRO
-------------	------	----------------	------	-----------------------------	------------------------------------------------------------------------------------------------------------------------------------------------------------------------------------	-------------------------------

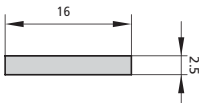
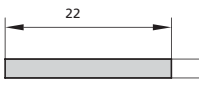

- Picaporte y palanca
- No incluye cilindro

Opciones de cerradero  
(ver página 41 - 47)

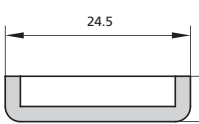
	P2E5/30/6	27 43 15	Al	CN	1		
	P2E5/35/6	32 48 15	Al	CN	1		
	P2E5/40/6	37 53 15	Al	CN	1		
	P2E5/45/6	42 58 15	Al	CN	1		
	P2E5/50/6	47 63 15	Al	CN	1		
	2E5/30/6L	27 43 15	Al	CN	1		
	2E5/35/6L	32 48 15	Al	CN	1		
	2E5/40/6L	37 53 15	Al	CN	1		
	2E5/45/6L	42 58 15	Al	CN	1		
	2E5/50/6L	47 63 15	Al	CN	1		
	2E5/30/6LAN	27 43 15	Al	CN	1		
	2E5/35/6LAN	32 48 15	Al	CN	1		
	2E5/40/6LAN	37 53 15	Al	CN	1		
	2E5/45/6LAN	42 58 15	Al	CN	1		
	2E5/50/6LAN	47 63 15	Al	CN	1		
	2E5/30/6U	23 39 15	Al	CN	1		
	2E5/35/6U	28 44 15	Al	CN	1		
	2E5/40/6U	33 49 15	Al	CN	1		
	2E5/45/6U	38 54 15	Al	CN	1		
	2E5/50/6U	43 59 15	Al	CN	1		

## PALANCA DESLIZANTE ENTRE EJES 92 mm.

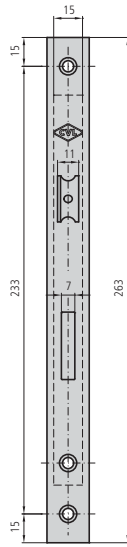
SERIE 1E2 **Soft**

## CARACTERÍSTICAS

- Máxima suavidad mediante engranajes
- Frente liso inox de 16mm, 22mm, 24mm y U 24,5\*6
- Picaporte reversible y regulable de 11mm
- Mínimo stock: 3 versiones en 1 cerradura (picaporte/rodillo/sólo palanca)
- Palanca deslizante de 20mm de salida
- Diseño según norma EN 12209 Y pr. EN 15685
- Caja cerrada de 15mm
- Cuadradillo de 8mm
- 2 escudos de nylon ref. ES1984
- Tornillo de fijación de cilindro
- 2 terminales de frente de nylon ref. EMB196 para frente liso (para frente de 22 mm.)

## ACCESORIOS OPCIONALES

- Gama completa de cerraderos (ver página 41 - 47)
- Gama completa de cilindros (ver página 127 - 148)

## DESCRIPCIÓN

## REF.

## MEDIDAS

## LEVA

## ACABADOS

## UDS

## PRECIO

B

A

FRENTE CILINDRO

COMPLETA S/CILINDRO

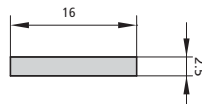

P1E2/30/6	27	43	15	Al	CN	1		
P1E2/35/6	32	48	15	Al	CN	1		
P1E2/40/6	37	53	15	Al	CN	1		
P1E2/45/6	42	58	15	Al	CN	1		
P1E2/50/6	47	63	15	Al	CN	1		

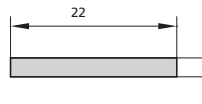

1E2/30/6	27	43	15	Al	CN	1		
1E2/35/6	32	48	15	Al	CN	1		
1E2/40/6	37	53	15	Al	CN	1		
1E2/45/6	42	58	15	Al	CN	1		
1E2/50/6	47	63	15	Al	CN	1		

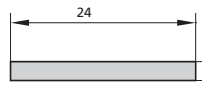

1E2/30/6AN	27	43	15	Al	CN	1		
1E2/35/6AN	32	48	15	Al	CN	1		
1E2/40/6AN	37	53	15	Al	CN	1		
1E2/45/6AN	42	58	15	Al	CN	1		
1E2/50/6AN	47	63	15	Al	CN	1		

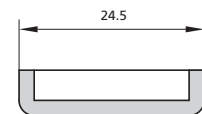

1E2/30/6U	23	39	15	Al	CN	1		
1E2/35/6U	28	44	15	Al	CN	1		
1E2/40/6U	33	49	15	Al	CN	1		
1E2/45/6U	38	54	15	Al	CN	1		
1E2/50/6U	43	59	15	Al	CN	1		

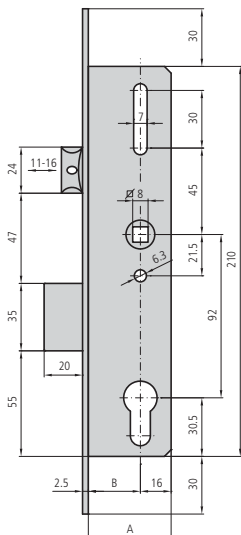

- Picaporte y palanca
- No incluye cilindro

**Opciones de cerradero**  
(ver página 41 - 47)



MULTIPUNTO PALANCA DESLIZANTE ENTRE EJES 92 mm.

SERIE 2E2 Soft

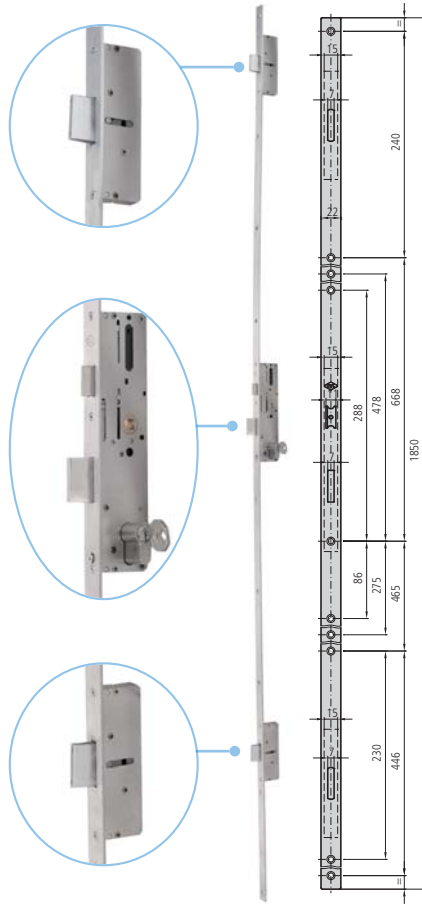

CARACTERÍSTICAS

- Máxima suavidad mediante engranajes
- Frente liso inox de 16mm, 22mm, 24mm y U 24,5\*6
- Frente de 1850mm de largo
- Picaporte reversible y regulable de 11mm
- Mínimo stock: 3 versiones en 1 cerradura (picaporte/rodillo/sólo palanca)
- Palanca deslizante de 20mm de salida
- Diseño según norma EN 12209 Y pr. EN 15685
- Caja cerrada de 15mm
- Cuadradillo de 8mm
- 2 escudos de nylon ref. ES1984
- Tornillo de fijación de cilindro

ACCESORIOS OPCIONALES

- Gama completa de cerraderos (ver página 41 - 47)
- Gama completa de cilindros (ver página 127 - 148)

DESCRIPCIÓN	REF.	MEDIDAS B A	LEVA	ACABADOS FRENTE CILINDRO	UDS  	PRECIO COMPLETA S/CILINDRO
-------------	------	----------------	------	-----------------------------	------------------------------------------------------------------------------------------------------------------------------------------------------------------------------------	-------------------------------

- Picaporte y palanca
- No incluye cilindro

Opciones de cerradero  
(ver página 41 - 47)

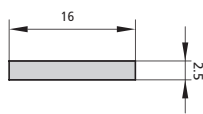
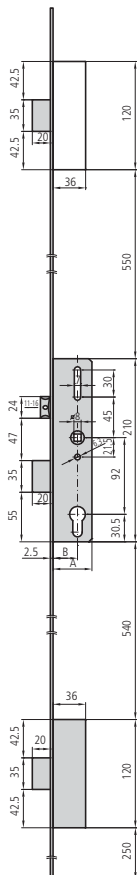

P2E2/30/6	27	43	15	Al	CN	1		
P2E2/35/6	32	48	15	Al	CN	1		
P2E2/40/6	37	53	15	Al	CN	1		
P2E2/45/6	42	58	15	Al	CN	1		
P2E2/50/6	47	63	15	Al	CN	1		

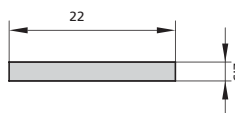

2E2/30/6L	27	43	15	Al	CN	1		
2E2/35/6L	32	48	15	Al	CN	1		
2E2/40/6L	37	53	15	Al	CN	1		
2E2/45/6L	42	58	15	Al	CN	1		
2E2/50/6L	47	63	15	Al	CN	1		

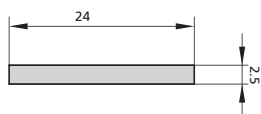

2E2/30/6LAN	27	43	15	Al	CN	1		
2E2/35/6LAN	32	48	15	Al	CN	1		
2E2/40/6LAN	37	53	15	Al	CN	1		
2E2/45/6LAN	42	58	15	Al	CN	1		
2E2/50/6LAN	47	63	15	Al	CN	1		

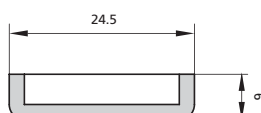

2E2/30/6U	23	39	15	Al	CN	1		
2E2/35/6U	28	44	15	Al	CN	1		
2E2/40/6U	33	49	15	Al	CN	1		
2E2/45/6U	38	54	15	Al	CN	1		
2E2/50/6U	43	59	15	Al	CN	1		

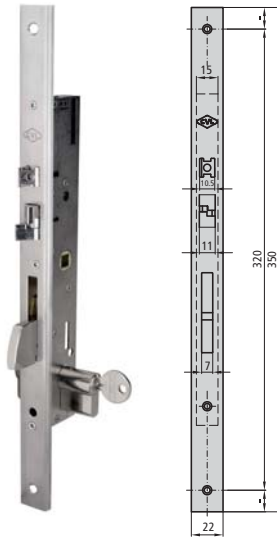

**PALANCA BASCULANTE ENTRE EJES 85 mm.**
**SERIE 1K5 DUE**

**CARACTERÍSTICAS**

- Cerradura eléctrica 12V/24V con apertura eléctrica automática con manilla o con cilindro
- Cerradura de 1 punto con frente liso inox de 16mm, 22mm, 24mm y U 24,5\*6
- Sistema antitarjeta
- Compatible para CA y CC
- Mínimo esfuerzo para cierre de puerta
- Caja de 15mm
- Cuadradillo de 8mm
- 2 escudos de nylon ES1984
- Cerraderos de serie según cerradura
- Tornillo de fijación de cilindro
- 2 terminales de frente de nylon ref. EMB196 para frente liso (para frente de 22 mm.)

**ACCESORIOS OPCIONALES**

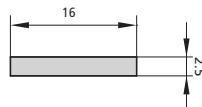
- Cerraderos según cerradura (ver página 41 - 47)
- Gama completa de cilindros (ver página 127 - 148)

DESCRIPCIÓN	REF.	MEDIDAS		LEVA	ACABADOS		UDS	PRECIO
		B	A		FRENTE	CILINDRO		



P1K5/30/6	27	42	15	Al	CN	1		
P1K5/35/6	32	47	15	Al	CN	1		

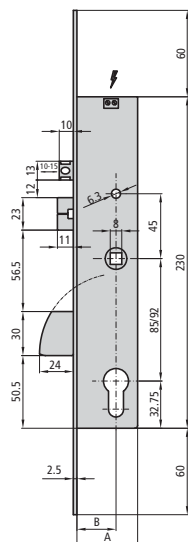

- Picaporte y palanca
- No incluye cilindro
- Incluye cerradero ref. KCE1K5/6L

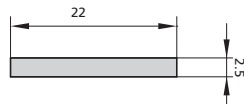

1K5/30/6	27	42	15	Al	CN	1		
1K5/33/6	30	43	13,25	Al	CN	1		
1K5/35/6	32	47	15	Al	CN	1		

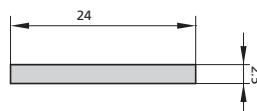

1K5/30/6AN	27	42	15	Al	CN	1		
1K5/33/6AN	30	43	13,25	Al	CN	1		
1K5/35/6AN	32	47	15	Al	CN	1		

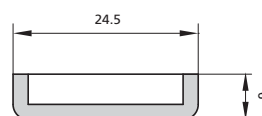

1K5/30/6U	23	38	15	Al	CN	1		
1K5/35/6U	28	43	15	Al	CN	1		

**MULTIPUNTO PALANCA BASCULANTE ENTRE EJES 85 mm.**

**SERIE 2K5 DUE**

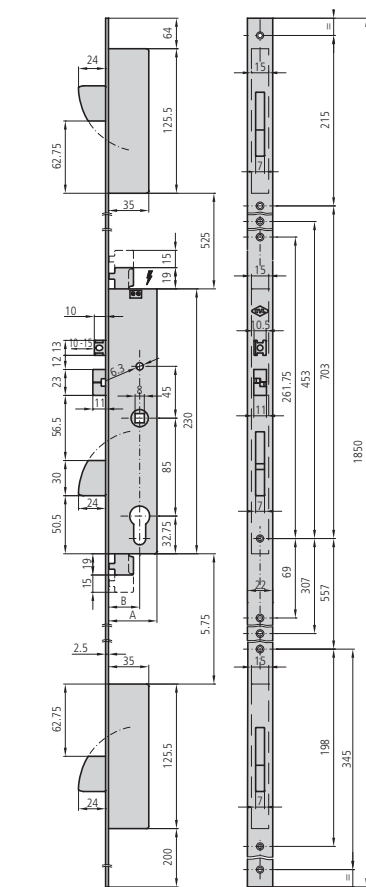

**CARACTERÍSTICAS**

- Cerradura eléctrica 12V/24V con apertura eléctrica automática con manilla o con cilindro
- Cerradura de 3 puntos con frente liso inox de 16mm, 22mm, 24mm y U 24,5\*6
- Frente de 1850mm de largo
- Sistema antitarjeta
- Compatible para CA y CC
- Mínimo esfuerzo para cierre de puerta
- Caja de 15mm
- Cuadradillo de 8mm
- Escudo de seguridad pasante BTI196/1N
- Cerraderos de serie según cerradura
- Tornillo de fijación de cilindro

**ACCESORIOS OPCIONALES**

- Cerraderos según cerradura (ver página 41 - 47)
- Gama completa de cilindros (ver página 127 - 148)

**DESCRIPCIÓN**

REF.	MEDIDAS B A	LEVA	ACABADOS FRENTE CILINDRO	UDS 	PRECIO COMPLETA S/CILINDRO
------	----------------	------	-----------------------------	---------	-------------------------------

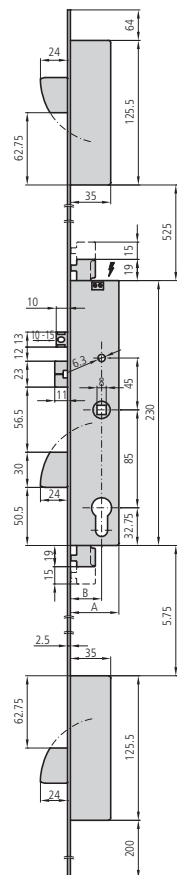

- Picaporte y palanca
- No incluye cilindro
- Incluye cerradero ref. KCE1K5/6L
- 2 unidades alto/bajo: CE296S/6L

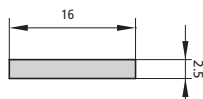

P2K5/30/6	27 42	15	Al CN	1	
P2K5/35/6	32 47	15	Al CN	1	

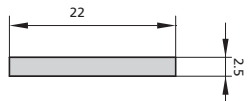

2K5/30/6L	27 42	15	Al CN	1	
2K5/33/6L	30 43	13,25	Al CN	1	
2K5/35/6L	32 47	15	Al CN	1	

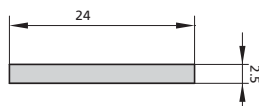

2K5/30/6LAN	27 42	15	Al CN	1	
2K5/33/6LAN	30 43	13,25	Al CN	1	
2K5/35/6LAN	32 47	15	Al CN	1	

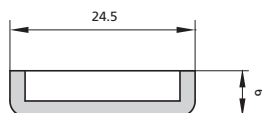

2K5/30/6U	23 38	15	Al CN	1	
2K5/35/6U	28 43	15	Al CN	1	

## MULTIPUNTO PALANCA DESLIZANTE ENTRE EJES 92 mm.

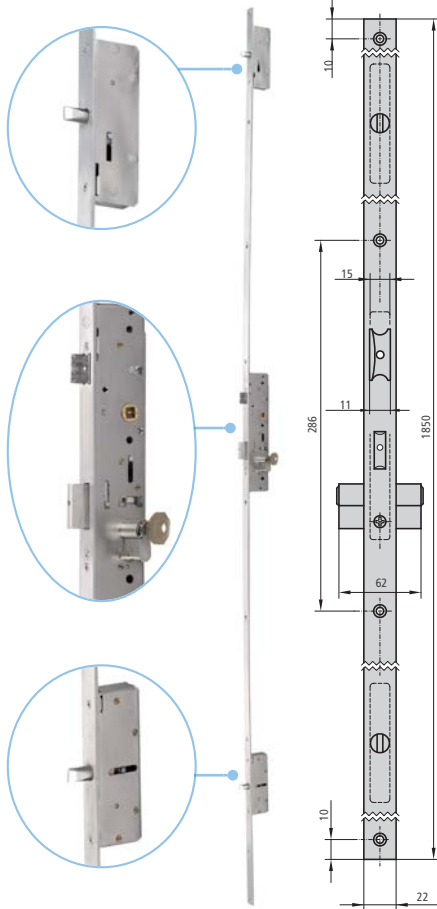
SERIE 202 **inve**®se

## CARACTERÍSTICAS

- Cerradura de 3 puntos con facilidad de cierre mediante manilla hacia arriba y bloqueo mediante llave
- Frente liso inox de 16mm, 22mm, 24mm y U 24,5\*6
- Frente de 1850mm de largo
- Picaporte de 11mm reversible y regulable
- Palanca central deslizante reforzada
- Caja cerrada de 15mm
- Cuadradillo de 8mm
- 2 escudos de nylon ES1984
- Tornillo de fijación de cilindro

## ACCESORIOS OPCIONALES

- Gama completa de cerraderos (ver página 41 - 47)
- Gama completa de cilindros (ver página 127 - 148)

## DESCRIPCIÓN

REF. MEDIDAS LEVA ACABADOS UDS. PRECIO  
B A FRENTE CILINDRO COMPLETA S/CILINDRO

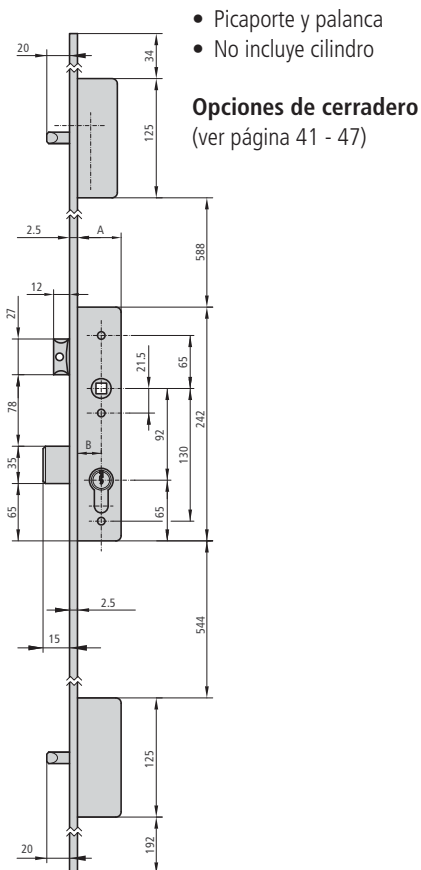

- Picaporte y palanca
- No incluye cilindro

Opciones de cerradero  
(ver página 41 - 47)

REF.	MEDIDAS B	MEDIDAS A	LEVA	ACABADOS FRENTE	ACABADOS CILINDRO	UDS.	PRECIO COMPLETA	PRECIO S/CILINDRO
P202/30/6	27	42	15	Al	CN	1		
P202/33/6	30	45	15	Al	CN	1		
P202/35/6	32	47	15	Al	CN	1		
202/30/6L	27	42	15	Al	CN	1		
202/33/6L	30	45	15	Al	CN	1		
202/35/6L	32	47	15	Al	CN	1		
202/30/6LAN	27	42	15	Al	CN	1		
202/33/6LAN	30	45	15	Al	CN	1		
202/35/6LAN	32	47	15	Al	CN	1		
202/30/6U	23	38	15	Al	CN	1		
202/33/6U	26	41	15	Al	CN	1		
202/35/6U	28	43	15	Al	CN	1		



**MULTIPUNTO PALANCA DESLIZANTE ENTRE EJES 92 mm.**

**SERIE 302 *inve*se**

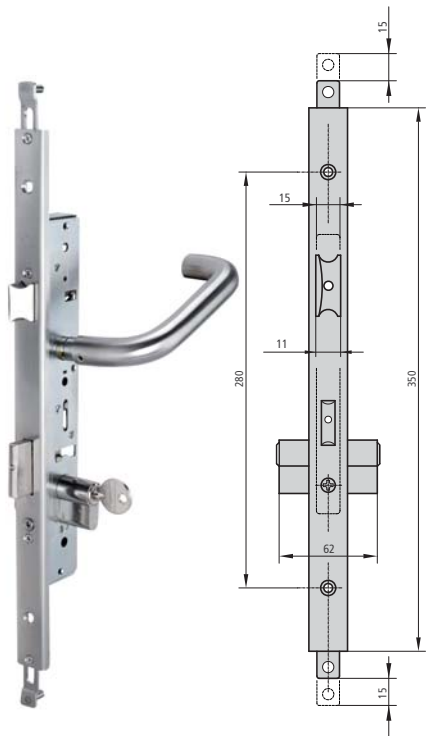

**CARACTERÍSTICAS**

- Cerradura de 3 puntos central y alto/bajo con facilidad de cierre mediante manilla hacia arriba y bloqueo mediante llave
- Frente liso inox de 16mm, 22mm, 24mm y U 24,5\*6
- Frente de 1850mm de largo
- Picaporte de 11mm reversible y regulable
- Palanca central deslizante reforzada
- Caja cerrada de 15mm
- Cuadradillo de 8mm
- 2 escudos de nylon ES1984
- Tornillo de fijación de cilindro

**ACCESORIOS OPCIONALES**

- Gama completa de cerraderos (ver página 41 - 47)
- Gama completa de cilindros (ver página 127 - 148)

DESCRIPCIÓN	REF.	MEDIDAS B A	LEVA	ACABADOS FRENTE CILINDRO	UDS 	PRECIO COMPLETA S/CILINDRO
-------------	------	----------------	------	-----------------------------	---------	-------------------------------

- Picaporte y palanca
- No incluye cilindro

**Opciones de cerradero**  
(ver página 41 - 47)

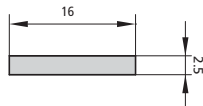
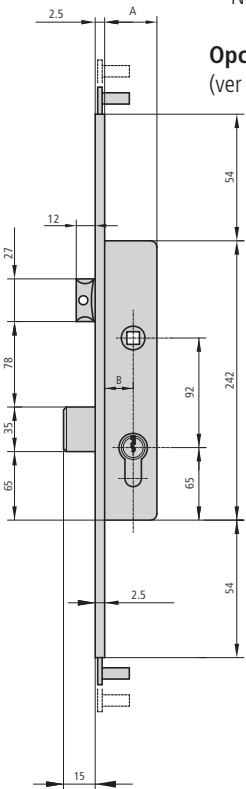

P302/30/6	27	42	15	Al	CN	1		
P302/33/6	30	45	15	Al	CN	1		
P302/35/6	32	47	15	Al	CN	1		

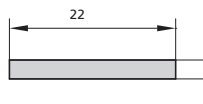

302/30/6L	27	42	15	Al	CN	1		
302/33/6L	30	45	15	Al	CN	1		
302/35/6L	32	47	15	Al	CN	1		

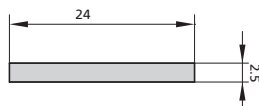

302/30/6LAN	27	42	15	Al	CN	1		
302/33/6LAN	30	45	15	Al	CN	1		
302/35/6LAN	32	47	15	Al	CN	1		

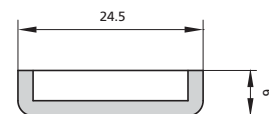

302/30/6U	23	38	15	Al	CN	1		
302/33/6U	26	41	15	Al	CN	1		
302/35/6U	28	43	15	Al	CN	1		

**PALANCA DESLIZANTE ENTRE EJES 85 mm.**

**SERIE 184**

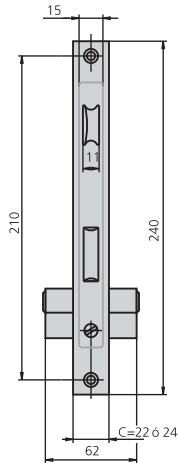

**CARACTERÍSTICAS**

- Frente de 22mm ó 24mm
- Picaporte reversible de 11mm
- Caja bicromatada de 15mm
- Cuadradillo de 8mm
- 2 escudos de nylon ref. ES1984
- 2 terminales de frente de nylon ref. EMB196 (para frente de 22mm)
- Tornillo de fijación de cilindro

**ACCESORIOS OPCIONALES**

- Cerraderos según cerradura (ver abajo)
- Gama completa de cilindros (ver página 127 - 148)
- Escudo de seguridad BT194 (ver página 49)

DESCRIPCIÓN	REF.	MEDIDAS		LEVA	ACABADOS		UDS		PRECIO
		B	A		FRENTE	CILINDRO			

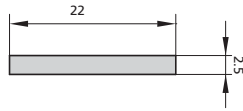

184/23/0	20	33	13,25	HN	CN	1	20		
184/23/6	20	33	13,25	AI	CN	1	20		
184/25/0	22	37	15	HN	CN	1	20		
184/25/6	22	37	15	AI	CN	1	20		
184/28/0	25	38	13,25	HN	CN	1	20		
184/28/6	25	38	13,25	AI	CN	1	20		
184/30/0	27	42	15	HN	CN	1	20		
184/30/6	27	42	15	AI	CN	1	20		
184/33/0	30	43	13,25	HN	CN	1	20		
184/33/6	30	43	13,25	AI	CN	1	20		
184/35/0	32	47	15	HN	CN	1	20		
184/35/6	32	47	15	AI	CN	1	20		
184/38/0	35	48	13,25	HN	CN	1	20		
184/38/6	35	48	13,25	AI	CN	1	20		

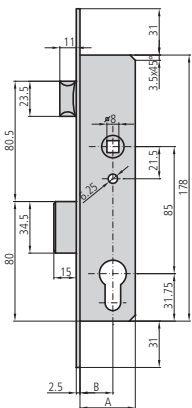

- Picaporte y palanca
- Cilindros de leva larga 5982/2525/4 ó de leva corta 5990/2525/4

**Opciones de cerradero**  
(ver página 41 - 47)

**Opción cerraderos eléctricos**  
(ver página 83)

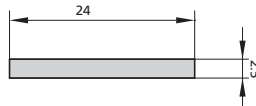

184/23/0AN	20	33	13,25	HN	CN	1	20		
184/23/6AN	20	33	13,25	AI	CN	1	20		
184/25/0AN	22	37	15	HN	CN	1	20		
184/25/6AN	22	37	15	AI	CN	1	20		
184/28/0AN	25	38	13,25	HN	CN	1	20		
184/28/6AN	25	38	13,25	AI	CN	1	20		
184/30/0AN	27	42	15	HN	CN	1	20		
184/30/6AN	27	42	15	AI	CN	1	20		
184/33/0AN	30	43	13,25	HN	CN	1	20		
184/33/6AN	30	43	13,25	AI	CN	1	20		
184/35/0AN	32	47	15	HN	CN	1	20		
184/35/6AN	32	47	15	AI	CN	1	20		
184/38/0AN	35	48	13,25	HN	CN	1	20		
184/38/6AN	35	48	13,25	AI	CN	1	20		



**PALANCA DESLIZANTE ENTRE EJES 85 mm.**
**SERIE 184**

DESCRIPCIÓN	REF.	MEDIDAS		LEVA	ACABADOS		UDS.		PRECIO		
		B	A		FRENTE	CILINDRO			COMPLETA	S/CILINDRO	
<ul style="list-style-type: none"> <li>• Sólo palanca</li> <li>• Cilindros de leva larga 5982/2525/4 ó de leva corta 5990/2525/4</li> </ul> <p><b>Opciones de cerradero</b> (ver página 41 - 47)</p>	184A23/0	20	33	13,25	HN	CN	1	30			
	184A23/6	20	33	13,25	AI	CN	1	30			
	184A25/0	22	37	15	HN	CN	1	30			
	184A25/6	22	37	15	AI	CN	1	30			
	184A28/0	25	38	13,25	HN	CN	1	30			
	184A28/6	25	38	13,25	AI	CN	1	30			
	184A30/0	27	42	15	HN	CN	1	30			
	184A30/6	27	42	15	AI	CN	1	30			
	184A33/0	30	43	13,25	HN	CN	1	30			
	184A33/6	30	43	13,25	AI	CN	1	30			
	184A35/0	32	47	15	HN	CN	1	30			
	184A35/6	32	47	15	AI	CN	1	30			
	184A38/0	35	48	13,25	HN	CN	1	30			
	184A38/6	35	48	13,25	AI	CN	1	30			
	<p><b>Opciones de cerradero</b> (ver página 41 - 47)</p>	184A23/0AN	20	33	13,25	HN	CN	1	30		
		184A23/6AN	20	33	13,25	AI	CN	1	30		
184A25/0AN		22	37	15	HN	CN	1	30			
184A25/6AN		22	37	15	AI	CN	1	30			
184A28/0AN		25	38	13,25	HN	CN	1	30			
184A28/6AN		25	38	13,25	AI	CN	1	30			
184A30/0AN		27	42	15	HN	CN	1	30			
184A30/6AN		27	42	15	AI	CN	1	30			
184A33/0AN		30	43	13,25	HN	CN	1	30			
184A33/6AN		30	43	13,25	AI	CN	1	30			
184A35/0AN		32	47	15	HN	CN	1	30			
184A35/6AN		32	47	15	AI	CN	1	30			
184A38/0AN		35	48	13,25	HN	CN	1	30			
184A38/6AN		35	48	13,25	AI	CN	1	30			

<ul style="list-style-type: none"> <li>• Con condena</li> </ul> <p><b>Opciones de cerradero</b> (ver página 41 - 47)</p>	184C23/6	20	33		AI		2	40			
	184C25/6	22	37		AI		2	40			
	184C28/6	25	38		AI		2	40			
	184C30/6	27	42		AI		2	40			
	184C33/6	30	43		AI		2	40			
	184C35/6	32	47		AI		2	40			
	184C38/6	35	48		AI		2	40			
		184C23/6AN	20	33		AI		2	40		
		184C25/6AN	22	37		AI		2	40		
		184C28/6AN	25	38		AI		2	40		
184C30/6AN		27	42		AI		2	40			
184C33/6AN		30	43		AI		2	40			
184C35/6AN		32	47		AI		2	40			
184C38/6AN	35	48		AI		2	40				

## PALANCA DESLIZANTE ENTRE EJES 85 mm.

## SERIE 184

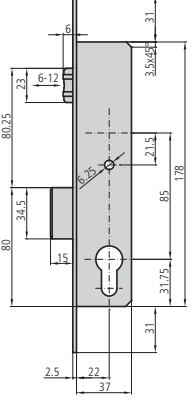
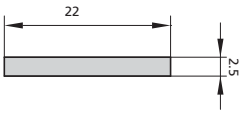
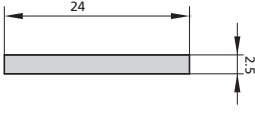
DESCRIPCIÓN	REF.	MEDIDAS		LEVA	ACABADOS		UDS		PRECIO		
		B	A		FRENTE	CILINDRO			COMPLETA	S/CILINDRO	
 <ul style="list-style-type: none"> <li>Rodillo vaivén regulable y palanca</li> <li>Cilindros de leva larga 5982/2525/4 ó de leva corta 5990/2525/4</li> </ul> <p><b>Opciones de cerradero</b> (ver página 41 - 47)</p> 	184V23/6	20	33	13,25	Al	CN	1	20			
	184V25/6	22	37	15	Al	CN	1	20			
	184V28/6	25	38	13,25	Al	CN	1	20			
	184V30/6	27	42	15	Al	CN	1	20			
	184V33/6	30	43	13,25	Al	CN	1	20			
	184V35/6	32	47	15	Al	CN	1	20			
	184V38/6	35	478	13,25	Al	CN	1	20			
	184V23/6AN	20	33	13,25	Al	CN	1	20			
	184V25/6AN	22	37	15	Al	CN	1	20			
	184V28/6AN	25	38	13,25	Al	CN	1	20			
	184V30/6AN	27	42	15	Al	CN	1	20			
	184V33/6AN	30	43	13,25	Al	CN	1	20			
	184V35/6AN	32	47	15	Al	CN	1	20			
	184V38/6AN	35	48	13,25	Al	CN	1	20			

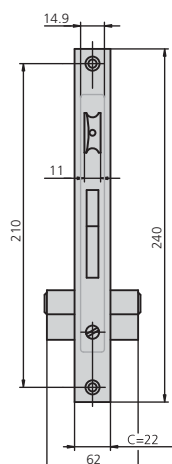
**PALANCA BASCULANTE ENTRE EJES 85 mm.**
**SERIE 196**

**CARACTERÍSTICAS**

- Frente inox de 22mm ó 24mm ó frente U de 24,5 x 6
- Picaporte reversible de 11mm
- Picaporte regulable excepto en entrada 25mm y 28mm
- Caja bicromatada de 15mm
- Cuadradillo de 8mm
- 2 escudos de nylon ref. ES1984
- 2 terminales de frente de nylon ref. EMB196 (para frente de 22mm)
- Tornillo de fijación de cilindro

**ACCESORIOS OPCIONALES**



- Cerraderos según cerradura (ver abajo)
- Gama completa de cilindros (ver página 127 - 148)
- Escudo de seguridad pasante ref. BT1296 (ver página 49)

DESCRIPCIÓN	REF.	MEDIDAS		LEVA	ACABADOS		UDS		PRECIO	
		B	A		FRENTE	CILINDRO			COMPLETA	S/CILINDRO
<ul style="list-style-type: none"> <li>• Picaporte y palanca</li> <li>• Cilindro de leva larga 5982/2525/4 ó de leva corta 5990/2525/4</li> </ul>	196/25/6	22	37	15	Al	CN	1	20		
	196/28/6	25	38	13,25	Al	CN	1	20		
	196/30/6	27	42	15	Al	CN	1	20		
	196/33/6	30	43	13,25	Al	CN	1	20		
	196/35/6	32	47	15	Al	CN	1	20		
	196/38/6	35	48	13,25	Al	CN	1	20		
	<p><b>Opciones de cerradero</b> (ver página 41 - 47)</p> <p><b>Opción cerradero eléctrico</b> (ver página 83)</p>	196/25/6AN	22	37	15	Al	CN	1	20	
196/28/6AN		25	38	13,25	Al	CN	1	20		
196/30/6AN		27	42	15	Al	CN	1	20		
196/33/6AN		30	43	13,25	Al	CN	1	20		
196/35/6AN		32	47	15	Al	CN	1	20		
196/38/6AN		35	48	13,25	Al	CN	1	20		
	196/25/6U	18	33	15	Al	CN	1	20		
	196/30/6U	23	38	15	Al	CN	1	20		
	196/35/6U	28	43	15	Al	CN	1	20		



## PALANCA BASCULANTE ENTRE EJES 85 mm.

## SERIE 196

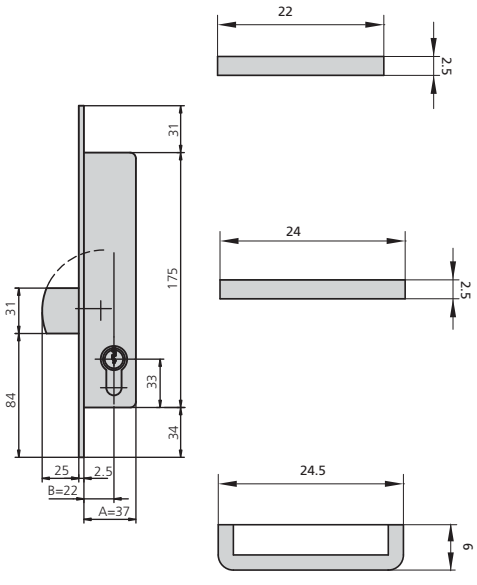
DESCRIPCIÓN	REF.	MEDIDAS		LEVA	ACABADOS		UDS		PRECIO	
		B	A		FRENTE	CILINDRO			COMPLETA	S/CILINDRO
	196A25/6	22	37	15	Al	CN	1	20		
	196A28/6	25	38	13,25	Al	CN	1	20		
	196A30/6	27	42	15	Al	CN	1	20		
	196A33/6	30	43	13,25	Al	CN	1	20		
	196A35/6	32	47	15	Al	CN	1	20		
	196A38/6	35	48	13,25	Al	CN	1	20		
	196A25/6AN	22	37	15	Al	CN	1	20		
	196A28/6AN	25	38	13,25	Al	CN	1	20		
	196A30/6AN	27	42	15	Al	CN	1	20		
	196A33/6AN	30	43	13,25	Al	CN	1	20		
	196A35/6AN	32	47	15	Al	CN	1	20		
	196A38/6AN	35	48	13,25	Al	CN	1	20		
	196A25/6U	18	33	15	Al	CN	1	20		
	196A30/6U	23	38	15	Al	CN	1	20		
	196A35/6U	28	43	15	Al	CN	1	20		

- Sólo palanca
- Cilindro de leva larga 5982/2525/4 ó de leva corta 5990/2525/4

## Opciones de cerradero

(ver página 41 - 47)

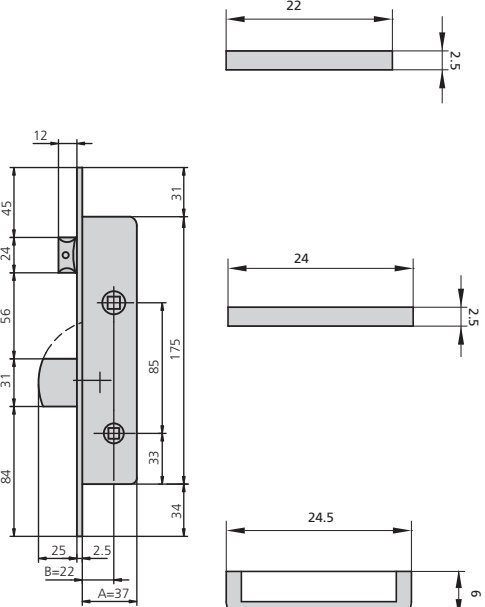
	196C25/6	22	37		Al		2	40		
	196C28/6	25	38		Al		2	40		
	196C30/6	27	42		Al		2	40		
	196C33/6	30	43		Al		2	40		
	196C35/6	32	47		Al		2	40		
	196C38/6	35	48		Al		2	40		
	196C25/6AN	22	37		Al		2	40		
	196C28/6AN	25	38		Al		2	40		
	196C30/6AN	27	42		Al		2	40		
	196C33/6AN	30	43		Al		2	40		
	196C35/6AN	32	47		Al		2	40		
	196C38/6AN	35	48		Al		2	40		
	196C25/6U	18	33		Al		2	40		
	196C30/6U	23	38		Al		2	40		
	196C35/6U	28	43		Al		2	40		

- Con condena y sin cilindro

## Opciones de cerradero

(ver página 41 - 47)

**PALANCA BASCULANTE ENTRE EJES 85 mm.**
**SERIE 196**

DESCRIPCIÓN	REF.	MEDIDAS		LEVA	ACABADOS		UDS		PRECIO	
		B	A		FRENTE	CILINDRO			COMPLETA	S/CILINDRO
	196T23/6	20	33	13,25	Al	CN	1	20		
	196T25/6	22	37	15	Al	CN	1	20		
	196T28/6	25	38	13,25	Al	CN	1	20		
	196T30/6	27	42	15	Al	CN	1	20		
	196T33/6	30	43	13,25	Al	CN	1	20		
	196T35/6	32	47	15	Al	CN	1	20		
	196T38/6	35	48	13,25	Al	CN	1	20		
	196T23/6AN	20	33	13,25	Al	CN	1	20		
	196T25/6AN	22	37	15	Al	CN	1	20		
	196T28/6AN	25	38	13,25	Al	CN	1	20		
196T30/6AN	27	42	15	Al	CN	1	20			
196T33/6AN	30	43	13,25	Al	CN	1	20			
196T35/6AN	32	47	15	Al	CN	1	20			
196T38/6AN	35	48	13,25	Al	CN	1	20			
	196T25/6U	18	33	15	Al	CN	1	20		
	196T30/6U	23	38	15	Al	CN	1	20		
	196T35/6U	28	43	15	Al	CN	1	20		

- Sólo picaporte y medio cilindro
- Cilindro 5982T40/4

**Opción cerradero eléctrico**

(ver página 83)

	196R23/6	20	33		Al	CN	1	20		
	196R25/6	22	37		Al	CN	1	20		
	196R28/6	25	38		Al	CN	1	20		
	196R30/6	27	42		Al	CN	1	20		
	196R33/6	30	43		Al	CN	1	20		
	196R35/6	32	47		Al	CN	1	20		
	196R38/6	35	48		Al	CN	1	20		
	196R23/6AN	20	33		Al	CN	1	20		
	196R25/6AN	22	37		Al	CN	1	20		
	196R28/6AN	25	38		Al	CN	1	20		
196R30/6AN	27	42		Al	CN	1	20			
196R33/6AN	30	43		Al	CN	1	20			
196R35/6AN	32	47		Al	CN	1	20			
196R38/6AN	35	48		Al	CN	1	20			
	196R25/6U	18	33		Al	CN	1	20		
	196R30/6U	23	38		Al	CN	1	20		
	196R35/6U	28	43		Al	CN	1	20		



- Solo picaporte y sin cilindro

**Opciones de cerradero**

(ver página 41 - 47)

## PALANCA BASCULANTE ENTRE EJES 85 mm.

## SERIE 196

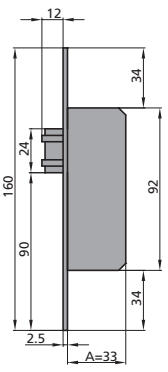
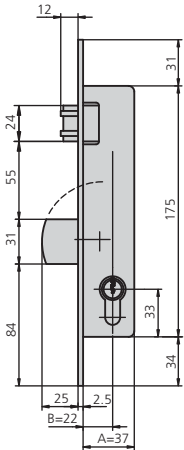
DESCRIPCIÓN	REF.	MEDIDAS		LEVA	ACABADOS		UDS		PRECIO		
		B	A		FRENTE	CILINDRO			COMPLETA	S/CILINDRO	
											
<ul style="list-style-type: none"> <li>Sólo vaivén</li> </ul>											
<b>Opciones de cerradero</b> (ver página 41 - 47)											
	196RV/6	22	33		Al	CN	1	20			
	196RV/6AN	24	33		Al	CN	1	20			
	196RV/6U	24.5	33		Al	CN	1	20			
											
	<ul style="list-style-type: none"> <li>Rodillo vaivén regulable y palanca</li> <li>Cilindro de leva larga 5982/2525/4 ó de leva corta 5990/2525/4</li> </ul>										
	<b>Opciones de cerradero</b> (ver página 41 - 47)										
		196V25/6	22	37	15	Al	CN	1	20		
		196V28/6	25	38	13,25	Al	CN	1	20		
	196V30/6	27	42	15	Al	CN	1	20			
	196V33/6	30	43	13,25	Al	CN	1	20			
	196V35/6	32	47	15	Al	CN	1	20			
	196V38/6	35	48	13,25	Al	CN	1	20			
	196V25/6AN	22	37	15	Al	CN	1	20			
	196V28/6AN	25	38	13,25	Al	CN	1	20			
	196V30/6AN	27	42	15	Al	CN	1	20			
	196V33/6AN	30	43	13,25	Al	CN	1	20			
	196V35/6AN	32	47	15	Al	CN	1	20			
	196V38/6AN	35	48	13,25	Al	CN	1	20			
	196V25/6U	24.5	33	15	Al	CN	1	20			
	196V30/6U	23	38	15	Al	CN	1	20			
	196V35/6U	28	43	15	Al	CN	1	20			

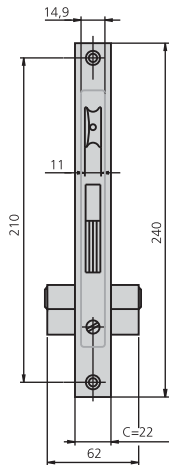
**PALANCA GANCHO ENTRE EJES 85 mm.**
**SERIE 197**

**CARACTERÍSTICAS**

- Frente inox de 22mm
- Picaporte reversible de 11mm
- Picaporte regulable excepto en entrada 25mm y 28mm
- Caja bicromatada de 15mm
- Cuadrado de 8mm
- 2 escudos de nylon ref. E51984
- 2 terminales de frente de nylon ref. EMB196 (para frente de 22mm)
- Tornillo de fijación de cilindro

**ACCESORIOS OPCIONALES**

- Cerraderos según cerradura (ver abajo)
- Gama completa de cilindros (ver página 127 - 148)
- Escudo de seguridad pasante ref. BTI296 (ver página 49)

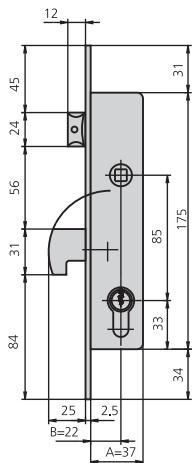
DESCRIPCIÓN	REF.	MEDIDAS		LEVA	ACABADOS		UDS		PRECIO	
		B	A		FRENTE	CILINDRO			COMPLETA	S/CILINDRO



- Picaporte y palanca gancho
- Cilindro de leva larga 5982/2525/4 ó de leva corta 5990/2525/4

**Opciones de cerradero**  
(ver página 41 - 47)

197/25/6	22	37	15	Al	CN	1	20		
197/28/6	25	38	13,25	Al	CN	1	20		
197/30/6	27	42	15	Al	CN	1	20		
197/33/6	30	43	13,25	Al	CN	1	20		
197/35/6	32	47	15	Al	CN	1	20		
197/38/6	35	48	13,25	Al	CN	1	20		

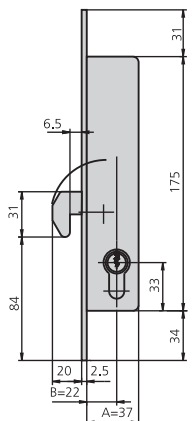

- Sólo palanca gancho
- Cilindro de leva larga 5982/2525/4 ó de leva corta 5990/2525/4

**Opciones de cerradero**  
(ver página 41 - 47)

197K25/6	22	37	15	Al	CN	1	20		
197K28/6	25	38	13,25	Al	CN	1	20		
197K30/6	27	42	15	Al	CN	1	20		
197K33/6	30	43	13,25	Al	CN	1	20		
197K35/6	32	47	15	Al	CN	1	20		
197K38/6	35	48	13,25	Al	CN	1	20		

## MULTIPUNTO PALANCA BASCULANTE ENTRE EJES 85 mm.

## SERIE 296

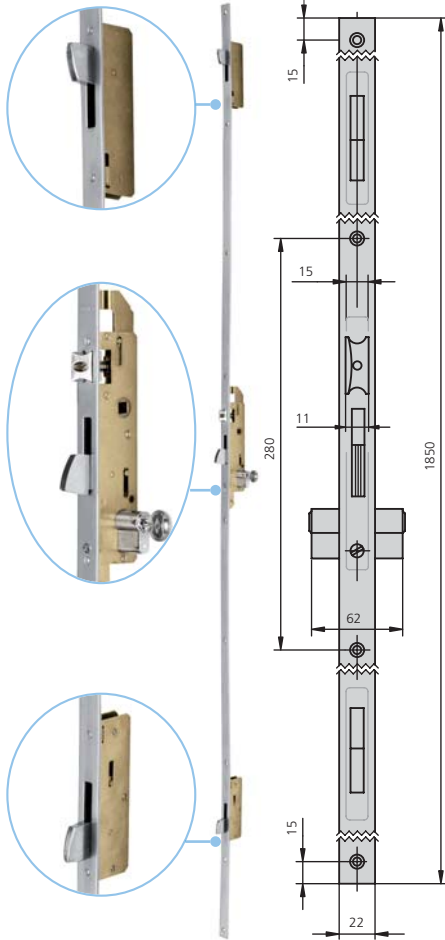

## CARACTERÍSTICAS

- Frente liso inox de 1850x22mm ó 1850x24mm ó frente U 1850x24,5x6
- Picaporte reversible de 11mm
- Picaporte regulable excepto en entrada 25mm y 28mm
- Caja bicromatada de 15mm
- Cuadradillo de 8mm
- Escudo de seguridad pasante ref. BTI296/1N
- Cerraderos de serie según cerradura
- Tornillo de fijación de cilindro

## ACCESORIOS OPCIONALES

- Otros cerraderos según cerradura (ver abajo)
- Gama completa de cilindros de seguridad (ver página 136 - 141)

## DESCRIPCIÓN

## REF.

## MEDIDAS

## LEVA

## ACABADOS

## UDS

## PRECIO

B

A

FRENTE CILINDRO



COMPLETA S/CILINDRO

DESCRIPCIÓN	REF.	MEDIDAS		LEVA	ACABADOS		UDS	PRECIO	
		B	A		FRENTE	CILINDRO		COMPLETA	S/CILINDRO
	296/25/6L	22	37	15	Al	CN	1		
	296/28/6L	25	38	13,25	Al	CN	1		
	296/30/6L	27	42	15	Al	CN	1		
	296/33/6L	30	43	13,25	Al	CN	1		
	296/35/6L	32	47	15	Al	CN	1		
	296/38/6L	35	48	13,25	Al	CN	1		
	296/25/6LAN	22	37	15	Al	CN	1		
	296/28/6LAN	25	38	13,25	Al	CN	1		
	296/30/6LAN	27	42	15	Al	CN	1		
	296/33/6LAN	30	43	13,25	Al	CN	1		
	296/35/6LAN	32	47	15	Al	CN	1		
	296/38/6LAN	35	48	13,25	Al	CN	1		
296/25/6U	18	33	15	Al	CN	1			
296/30/6U	23	38	15	Al	CN	1			
296/35/6U	28	43	15	Al	CN	1			

- Picaporte y palanca
- Cilindro de leva larga 6982/2535/4 ó de leva corta 6990/2535/4

## Cerraderos de serie

- Central fijo inox: CE196/6L ó CE196/6LAN
- 2 unidades alto/bajo inox: CE296S/6L ó CE296S/6LAN

## Otras opciones de cerradero

(ver página 41 - 47)

## Opción cerradero eléctrico

(ver página 83)



**MULTIPUNTO PALANCA BASCULANTE ENTRE EJES 85 mm.**
**SERIE 296**

DESCRIPCIÓN	REF.	MEDIDAS		LEVA	ACABADOS		UDS	PRECIO	
		B	A		FRENTE	CILINDRO		COMPLETA	S/CILINDRO
	296A25/6L	22	37	15	Al	CN	1		
	296A28/6L	25	38	13,25	Al	CN	1		
	296A30/6L	27	42	15	Al	CN	1		
	296A33/6L	30	43	13,25	Al	CN	1		
	296A35/6L	32	47	15	Al	CN	1		
	296A38/6L	35	48	13,25	Al	CN	1		
	296A25/6LAN	22	37	15	Al	CN	1		
	296A28/6LAN	25	38	13,25	Al	CN	1		
	296A30/6LAN	27	42	15	Al	CN	1		
	296A33/6LAN	30	43	13,25	Al	CN	1		
	296A35/6LAN	32	47	15	Al	CN	1		
	296A38/6LAN	35	48	13,25	Al	CN	1		
296A25/6U	18	33	15	Al	CN	1			
296A30/6U	23	38	15	Al	CN	1			
296A35/6U	28	43	15	Al	CN	1			

- Sólo palanca
- Cilindro de leva larga 6982/2535/4 ó de leva corta 6990/2535/4

**Cerraderos de serie**

- 3 unidades fijo inox: CE296S/6L ó CE296S/6LAN

**Otras opciones de cerradero**

(ver página 41 - 47)

	296V25/6L	22	37	15	Al	CN	1		
	296V28/6L	25	38	13,25	Al	CN	1		
	296V30/6L	27	42	15	Al	CN	1		
	296V33/6L	30	43	13,25	Al	CN	1		
	296V35/6L	32	47	15	Al	CN	1		
	296V38/6L	35	48	13,25	Al	CN	1		
	296V25/6LAN	22	37	15	Al	CN	1		
	296V28/6LAN	25	38	13,25	Al	CN	1		
	296V30/6LAN	27	42	15	Al	CN	1		
	296V33/6LAN	30	43	13,25	Al	CN	1		
	296V35/6LAN	32	47	15	Al	CN	1		
	296V38/6LAN	35	48	13,25	Al	CN	1		
296V25/6U	18	33	15	Al	CN	1			
296V30/6U	23	38	15	Al	CN	1			
296V35/6U	28	43	15	Al	CN	1			

- Rodillo vaivén regulable y palanca
- Cilindro de leva larga 6982/2535/4 ó de leva corta 6990/2535/4

**Cerraderos de serie**

- Central fijo inox: CE196/6L ó CE196/6LAN
- 2 unidades alto/bajo inox: CE296S/6L ó CE296S/6LAN

**Otras opciones de cerradero**

(ver página 41 - 47)

## MULTIPUNTO FRENTE ESPECIAL PALANCA BASCULANTE ENTRE EJES 85 mm.

## SERIE 496

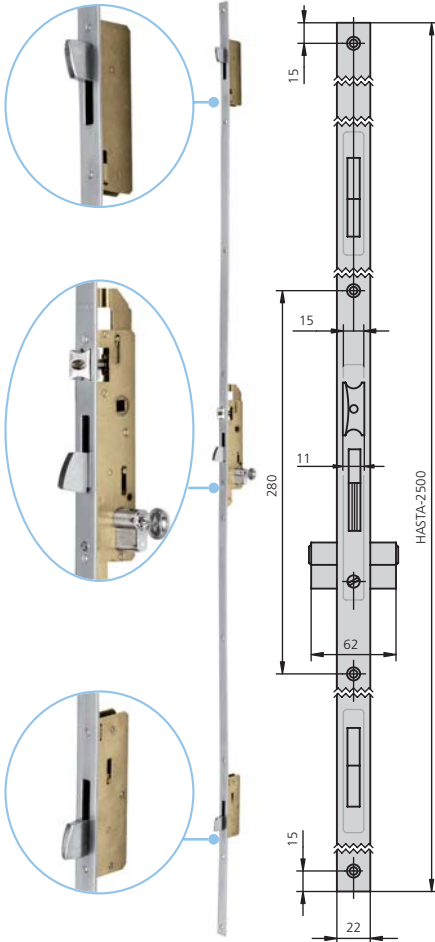

## CARACTERÍSTICAS

- Frente liso inox de 22mm ó 24mm de ancho y hasta 2.500mm de alto
- Picaporte reversible de 11mm
- Picaporte regulable excepto en entrada 25mm y 28mm
- Caja bicromatada de 15mm
- Cuadradillo de 8mm
- Escudo de seguridad pasante ref. BTI296/1N
- Cerraderos de serie según cerradura
- Tornillo de fijación de cilindro

## ACCESORIOS OPCIONALES

- Otros cerraderos según cerradura (ver abajo)
- Gama completa de cilindros de seguridad (ver página 136 - 141)

## DESCRIPCIÓN

## REF.

## MEDIDAS

## LEVA

## ACABADOS

## UDS

## PRECIO

B

A

FRENTE CILINDRO



COMPLETA S/CILINDRO

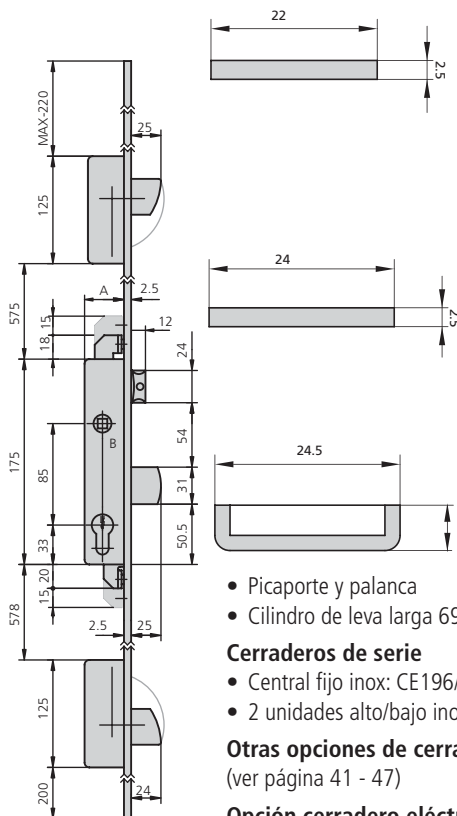

496/25/6L	22	37	15	Al	CN	1		
496/28/6L	25	38	13,25	Al	CN	1		
496/30/6L	27	42	15	Al	CN	1		
496/33/6L	30	43	13,25	Al	CN	1		
496/35/6L	32	47	15	Al	CN	1		
496/38/6L	35	48	13,25	Al	CN	1		
496/25/6LAN	22	37	15	Al	CN	1		
496/28/6LAN	25	38	13,25	Al	CN	1		
496/30/6LAN	27	42	15	Al	CN	1		
496/33/6LAN	30	43	13,25	Al	CN	1		
496/35/6LAN	32	47	15	Al	CN	1		
496/38/6LAN	35	48	13,25	Al	CN	1		
496/25/6U	18	33	15	Al	CN	1		
496/30/6U	23	38	15	Al	CN	1		
496/35/6U	28	43	15	Al	CN	1		

- Picaporte y palanca
- Cilindro de leva larga 6982/2535/4 ó de leva corta 6990/2535/4

## Cerraderos de serie

- Central fijo inox: CE196/6L ó CE196/6LAN
- 2 unidades alto/bajo inox: CE296S/6L ó CE296S/6LAN

## Otras opciones de cerradero

(ver página 41 - 47)

## Opción cerradero eléctrico

(ver página 83)

**MULTIPUNTO FRENTE ESPECIAL PALANCA BASCULANTE ENTRE EJES 85 mm.**
**SERIE 496**

DESCRIPCIÓN	REF.	MEDIDAS		LEVA	ACABADOS		UDS	PRECIO	
		B	A		FRENTE	CILINDRO		COMPLETA	S/CILINDRO
	496A25/6L	22	37	15	Al	CN	1		
	496A28/6L	25	38	13,25	Al	CN	1		
	496A30/6L	27	42	15	Al	CN	1		
	496A33/6L	30	43	13,25	Al	CN	1		
	496A35/6L	32	47	15	Al	CN	1		
	496A38/6L	35	48	13,25	Al	CN	1		
	496A25/6LAN	22	37	15	Al	CN	1		
	496A28/6LAN	25	38	13,25	Al	CN	1		
	496A30/6LAN	27	42	15	Al	CN	1		
	496A33/6LAN	30	43	13,25	Al	CN	1		
	496A35/6LAN	32	47	15	Al	CN	1		
	496A38/6LAN	32	47	15	Al	CN	1		
	496A25/6U	18	33	15	Al	CN	1		
	496A30/6U	23	38	15	Al	CN	1		
	496A35/6U	28	43	15	Al	CN	1		

• Sólo palanca  
 • Cilindro de leva larga 6982/2535/4 ó de leva corta 6990/2535/4

**Cerraderos de serie**  
 • 3 unidades fijo inox: CE296S/6L ó CE296S/6LAN

**Otras opciones de cerradero**  
 (ver página 41 - 47)

	496V25/6L	22	37	15	Al	CN	1		
	496V28/6L	25	38	13,25	Al	CN	1		
	496V30/6L	27	42	15	Al	CN	1		
	496V33/6L	30	43	13,25	Al	CN	1		
	496V35/6L	32	47	15	Al	CN	1		
	496V38/6L	35	48	13,25	Al	CN	1		
	496V25/6LAN	22	37	15	Al	CN	1		
	496V28/6LAN	25	38	13,25	Al	CN	1		
	496V30/6LAN	27	42	15	Al	CN	1		
	496V33/6LAN	30	43	13,25	Al	CN	1		
	496V35/6LAN	32	47	15	Al	CN	1		
	496V38/6LAN	35	48	13,25	Al	CN	1		
	496V25/6U	18	33	15	Al	CN	1		
	496V30/6U	23	38	15	Al	CN	1		
	496V35/6U	28	43	15	Al	CN	1		

• Rodillo vaivén regulable y palanca  
 • Cilindro de leva larga 6982/2535/4 ó de leva corta 6990/2535/4

**Cerraderos de serie**  
 • Central fijo inox: CE196/6L ó CE196/6LAN  
 • 2 unidades alto/bajo inox: CE296S/6L ó CE296S/6LAN

**Otras opciones de cerradero**  
 (ver página 41 - 47)

## MULTIPUNTO FRENTE ESPECIAL PALANCA BASCULANTE ENTRE EJES 85 mm.

## SERIE 596

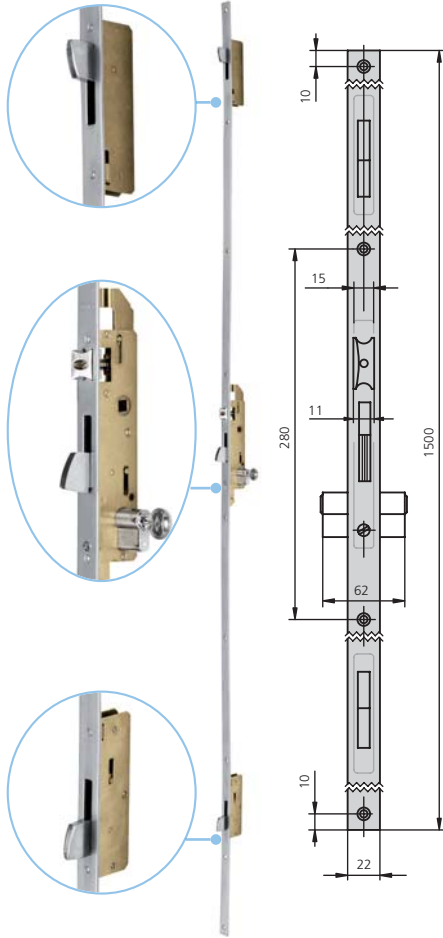

## CARACTERÍSTICAS

- Cerradura multipunto para puertas de doble hoja con pasadores en la hoja pasiva
- Frente liso inox de 22x1500mm
- Picaporte reversible de 11mm
- Picaporte regulable excepto en entrada 25mm y 28mm
- Caja bicromatada de 15mm
- Cuadradillo de 8mm
- Escudo de seguridad pasante ref. BTI296/1N
- Cerraderos de serie según cerradura
- Tornillo de fijación de cilindro

## ACCESORIOS OPCIONALES

- Otros cerraderos según cerradura (ver abajo)
- Gama completa de cilindros de seguridad (ver página 136 - 141)

## DESCRIPCIÓN

## REF.

MEDIDAS  
B A

## LEVA

ACABADOS  
FRENTE CILINDROUDS  
 

## PRECIO

## COMPLETA S/CILINDRO

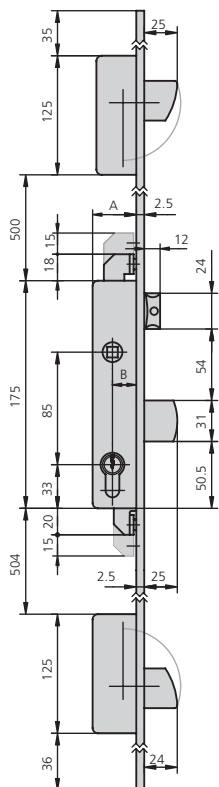

- Picaporte y palanca
- Cilindro de leva larga 6982/2535/4 ó de leva corta 6990/2535/4

## Cerraderos de serie

- Central fijo inox: CE196/6L ó CE196/6LAN
- 2 unidades alto/bajo inox: CE296S/6L ó CE296S/6LAN

## Otras opciones de cerradero

(ver página 41 - 47)

## Opción cerradero eléctrico

(Ver página 83)

596/25/6L	22	37	15	Al	CN	1		
596/28/6L	25	38	13,25	Al	CN	1		
596/30/6L	27	42	15	Al	CN	1		
596/33/6L	30	43	13,25	Al	CN	1		
596/35/6L	32	47	15	Al	CN	1		
596/38/6L	35	48	13,25	Al	CN	1		

**MULTIPUNTO FRENTE ESPECIAL PALANCA BASCULANTE ENTRE EJES 85 mm.**
**SERIE 596**

DESCRIPCIÓN	REF.	MEDIDAS		LEVA	ACABADOS		UDS	PRECIO	
		B	A		FRENTE	CILINDRO		COMPLETA	S/CILINDRO
<ul style="list-style-type: none"> <li>Sólo palanca</li> <li>Cilindro de leva larga 6982/2535/4 ó de leva corta 6990/2535/4</li> </ul>	596A25/6L	22	37	15	Al	CN	1		
	596A28/6L	25	38	13,25	Al	CN	1		
	596A30/6L	27	42	15	Al	CN	1		
	596A33/6L	30	43	13,25	Al	CN	1		
	596A35/6L	32	47	15	Al	CN	1		
	596A38/6L	35	48	13,25	Al	CN	1		

**Cerraderos de serie**

- 3 unidades fijo inox: CE296S/6L ó CE296S/6LAN

**Otras opciones de cerradero**

(ver página 41 - 47)

<ul style="list-style-type: none"> <li>Rodillo vaivén regulable y palanca</li> <li>Cilindro de leva larga 6982/2535/4 ó de leva corta 6990/2535/4</li> </ul>	596V25/6L	22	37	15	Al	CN	1		
	596V28/6L	25	38	13,25	Al	CN	1		
	596V30/6L	27	42	15	Al	CN	1		
	596V33/6L	30	43	13,25	Al	CN	1		
	596V35/6L	32	47	15	Al	CN	1		
	596V38/6L	35	48	13,25	Al	CN	1		

**Cerraderos de serie**

- Central fijo inox: CE196/6L ó CE196/6LAN
- 2 unidades alto/bajo inox: CE296S/6L ó CE296S/6LAN

**Otras opciones de cerradero**

(ver página 41 - 47)



## PALANCA DESLIZANTE ENTRE EJES 92 mm.

## SERIE 192

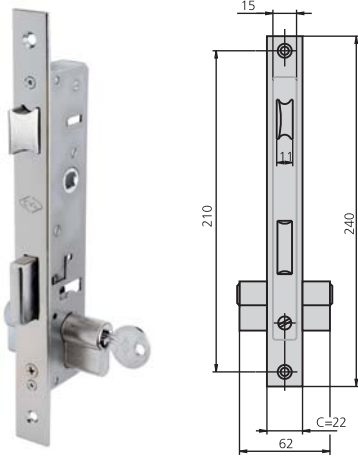

## CARACTERÍSTICAS

- Frente inox de 22mm ó 24mm
- Picaporte reversible de 11mm
- Caja zincada de 15mm
- Cuadradillo de 8mm
- 2 escudos de nylon ref. ES1984
- 2 terminales de frente de nylon ref. EMB196 para frente liso (para frente de 22mm)
- Tornillo de fijación de cilindro

## ACCESORIOS OPCIONALES

- Cerraderos según cerradura (ver abajo)
- Amplia gama de cilindros (ver página 127 - 148)
- Escudo de seguridad ref. BT194 (ver pág. 49)

## DESCRIPCIÓN

## REF.

## MEDIDAS

## LEVA

## ACABADOS

## UDS

## PRECIO

B

A

FRENTE

CILINDRO



COMPLETA

S/CILINDRO

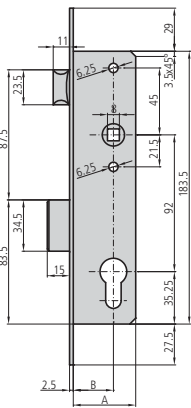

- Picaporte y palanca
- Cilindro europerfil leva DIN

Opciones de cerradero  
(ver página 41 - 47)Opción cerradero  
eléctrico  
(Ver página 83)

	22	2.5								
192/25/6	22	37	15	Al	CN	1	20			
192/30/6	27	42	15	Al	CN	1	20			
192/35/6	32	47	15	Al	CN	1	20			
192/25/6AN	22	37	15	Al	CN	1	20			
192/30/6AN	27	42	15	Al	CN	1	20			
192/35/6AN	32	47	15	Al	CN	1	20			

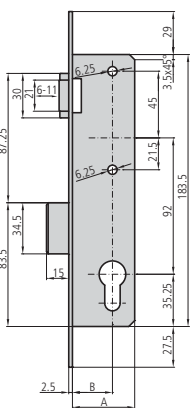

- Rodillo vaivén regulable y palanca
- Cilindro europerfil leva DIN

Opciones de cerradero  
(ver página 41 - 47)

	22	2.5								
192V25/6	22	37	15	Al	CN	1	20			
192V30/6	27	42	15	Al	CN	1	20			
192V35/6	32	47	15	Al	CN	1	20			
192V25/6AN	22	37	15	Al	CN	1	20			
192V30/6AN	27	42	15	Al	CN	1	20			
192V35/6AN	32	47	15	Al	CN	1	20			

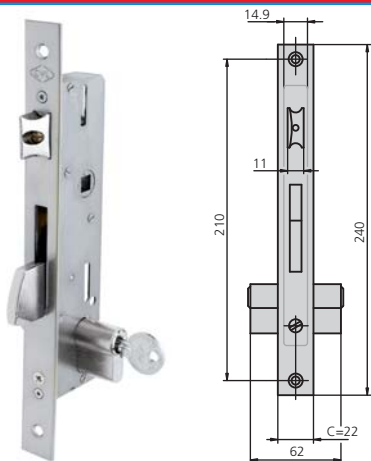
**PALANCA BASCULANTE ENTRE EJES 92 mm.**
**SERIE 194**

**CARACTERÍSTICAS**

- Frente liso inox de 22mm ó 24mm ó frente inox en U de 24,5x6
- Picaporte reversible de 11mm
- Picaporte regulable excepto en entrada 25mm
- Caja zincada de 15mm
- Cudradillo de 8mm
- 2 escudos de nylon ref. ES1984
- 2 terminales de frente de nylon ref. EMB196 para frente liso (para frente de 22mm)
- Tornillo de fijación de cilindro

**ACCESORIOS OPCIONALES**

- Cerraderos según cerradura (ver abajo)
- Amplia gama de cilindros (ver página 127 - 148)
- Escudo de seguridad pasante ref. BT1296 (ver pág. 49)

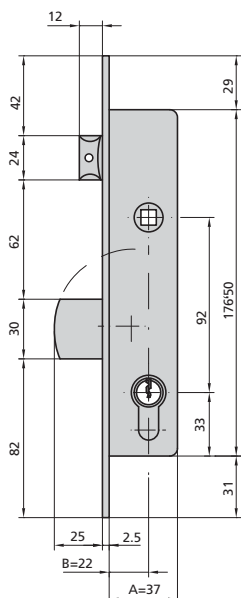
**DESCRIPCIÓN**
**REF.**
**MEDIDAS**
**LEVA**
**ACABADOS**
**UDS**

**PRECIO**
**B**
**A**
**FRENTE**
**CILINDRO**
**COMPLETA**
**S/CILINDRO**

- Picaporte y palanca
- Cilindro europerfil leva DIN

**Opciones de cerradero**  
(ver página 41 - 47)

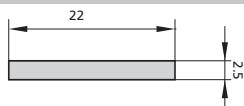
**Opción cerradero eléctrico**  
(Ver página 83)

194/25/6	22	37	15	Al	CN	1	20		
194/30/6	27	42	15	Al	CN	1	20		
194/35/6	32	47	15	Al	CN	1	20		

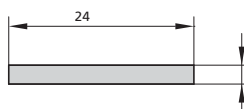

194/25/6AN	22	37	15	Al	CN	1	20		
194/30/6AN	27	42	15	Al	CN	1	20		
194/35/6AN	32	47	15	Al	CN	1	20		

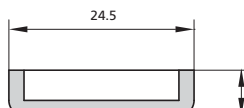

194/25/6U	18	33	15	Al U	CN	1	20		
194/30/6U	23	38	15	Al U	CN	1	20		
194/35/6U	28	43	15	Al U	CN	1	20		

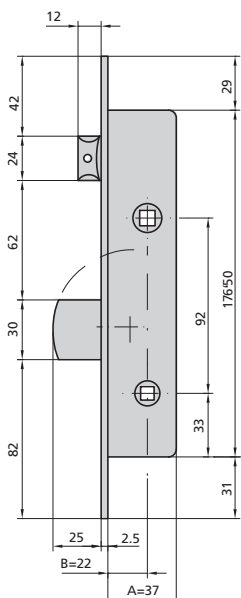

- Con condena
- Sin cilindro

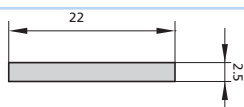
**Opciones de cerradero**  
(ver página 41 - 47)

194C25/6	22	37		Al		2	40		
194C30/6	27	42		Al		2	40		
194C35/6	32	47		Al		2	40		

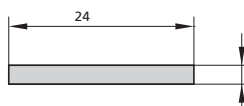

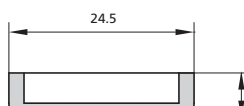

194C25/6AN	22	37		Al		2	40		
194C30/6AN	27	42		Al		2	40		
194C35/6AN	32	47		Al		2	40		



194C25/6U	18	33		Al U		2	40		
194C30/6U	23	38		Al U		2	40		
194C35/6U	28	43		Al U		2	40		

## PALANCA BASCULANTE ENTRE EJES 92 mm.

## SERIE 194

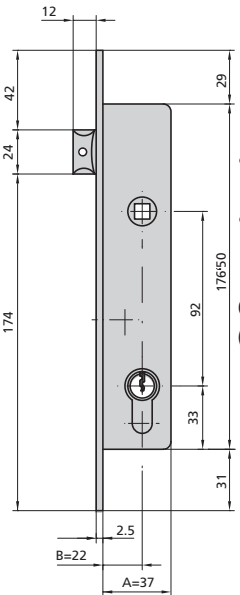
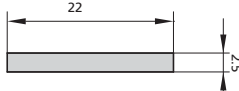
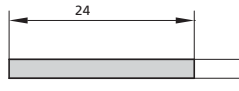
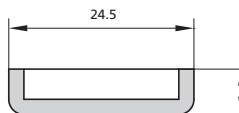
DESCRIPCIÓN	REF.	MEDIDAS		LEVA	ACABADOS		UDS		PRECIO		
		B	A		FRENTE	CILINDRO			COMPLETA	S/CILINDRO	
 <ul style="list-style-type: none"> <li>Sólo picaporte y medio cilindro</li> <li>Medio cilindro europerfil leva DIN</li> </ul> <p><b>Opciones de cerradero</b> (ver página 41 - 47)</p>											
	194T25/6	22	37	15	Al	CN	1	20			
	194T30/6	27	42	15	Al	CN	1	20			
	194T35/6	32	47	15	Al	CN	1	20			
											
	194T25/6AN	22	37	15	Al	CN	1	20			
	194T30/6AN	27	42	15	Al	CN	1	20			
	194T35/6AN	32	47	15	Al	CN	1	20			
											
	194T25/6U	18	33	15	Al U	CN	1	20			
	194T30/6U	23	38	15	Al U	CN	1	20			
	194T35/6U	28	43	15	Al U	CN	1	20			

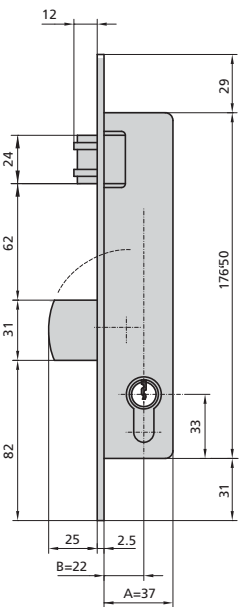
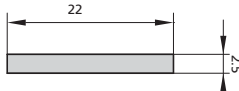
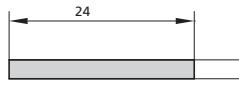
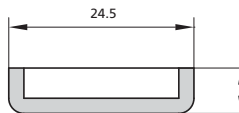
 <ul style="list-style-type: none"> <li>Rodillo vaivén regulable y palanca</li> <li>Cilindro europerfil leva DIN</li> </ul> <p><b>Opciones de cerradero</b> (ver página 41 - 47)</p>											
	194V25/6	22	37	15	Al	CN	1	20			
	194V30/6	27	42	15	Al	CN	1	20			
	194V35/6	32	47	15	Al	CN	1	20			
											
	194V25/6AN	22	37	15	Al	CN	1	20			
	194V30/6AN	27	42	15	Al	CN	1	20			
	194V35/6AN	32	47	15	Al	CN	1	20			
											
	194V25/6U	18	33	15	Al U	CN	1	20			
	194V30/6U	23	38	15	Al U	CN	1	20			
	194V35/6U	28	43	15	Al U	CN	1	20			

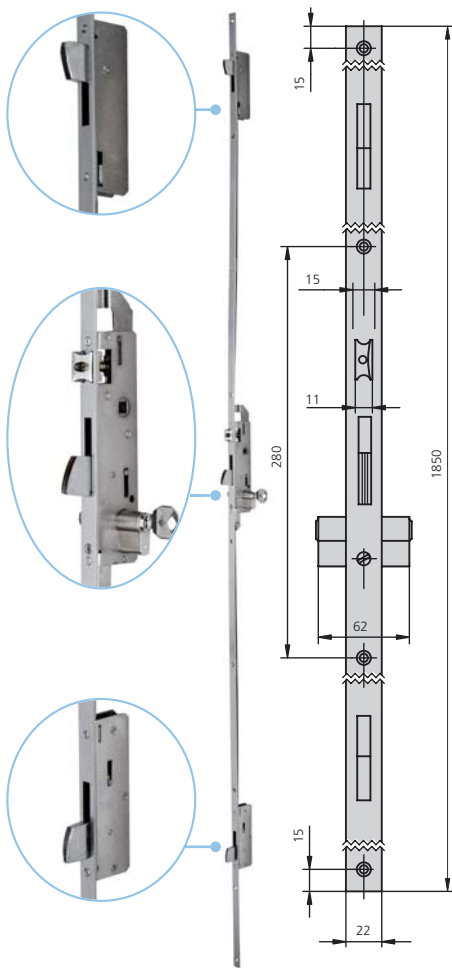
**MULTIPUNTO PALANCA BASCULANTE ENTRE EJES 92 mm.**
**SERIE 294**

**CARACTERÍSTICAS**

- Frente liso inox de 1850x22mm ó 1850x24mm ó frente U de 1850x24,5x6
- Picaporte reversible de 11mm
- Picaporte regulable excepto en entrada 25mm
- Caja zincada de 15mm
- Cuadradillo de 8mm
- Escudo de seguridad pasante ref. BTI296/1N
- Cerraderos de serie según cerradura
- Tornillo de fijación de cilindro

**ACCESORIOS OPCIONALES**

- Otros cerraderos según cerradura (ver abajo)
- Gama completa de cilindros de seguridad (ver página 136 - 141)

**DESCRIPCIÓN**
**REF.**
**MEDIDAS**  
 B A

**LEVA**
**ACABADOS**  
 FRENTE CILINDRO

**UDS**  
**PRECIO**

## COMPLETA S/CILINDRO

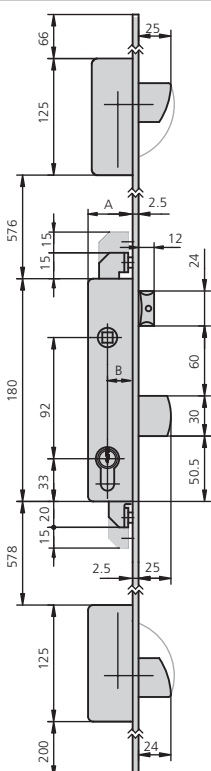

- Picaporte y palanca
- Cilindro europerfil de seguridad leva DIN

**Cerraderos de serie**

- Central fijo inox: CE196/6L ó CE196/6LAN
- 2 unidades alto/bajo inox: CE296S/6L ó CE296S/6LAN

**Otras opciones de cerradero**  
 (ver página 41 - 47)

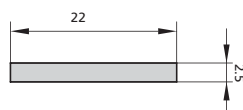
**Opción cerradero eléctrico**  
 (Ver página 83)

294/25/6L	22	37	15	Al	CN	1		
294/30/6L	27	42	15	Al	CN	1		
294/35/6L	32	47	15	Al	CN	1		

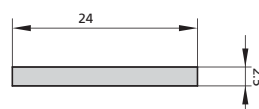

294/25/6LAN	22	37	15	Al	CN	1		
294/30/6LAN	27	42	15	Al	CN	1		
294/35/6LAN	32	47	15	Al	CN	1		

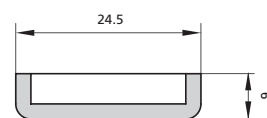

294/25/6U	18	33	15	Al	CN	1		
294/30/6U	23	38	15	Al	CN	1		
294/35/6U	28	43	15	Al	CN	1		

## MULTIPUNTO PALANCA BASCULANTE ENTRE EJES 92 mm.

## SERIE 294

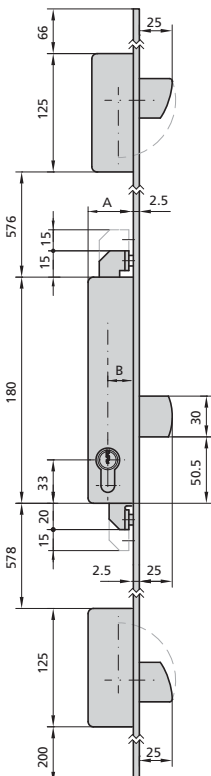
DESCRIPCIÓN	REF.	MEDIDAS		LEVA	ACABADOS		UDS	PRECIO	
		B	A		FRENTE	CILINDRO		COMPLETA	S/CILINDRO
 <ul style="list-style-type: none"> <li>Solo palanca</li> <li>Cilindro 6982/2535/4</li> </ul> <p><b>Cerraderos de serie</b></p> <ul style="list-style-type: none"> <li>3 unidades fijo inox: CE296S/6L ó CE296S/6LAN</li> </ul> <p><b>Otras opciones de cerradero</b> (ver página 41 - 47)</p>									
	294A25/6L	22	37	15	Al	CN	1		
	294A30/6L	27	42	15	Al	CN	1		
	294A35/6L	32	47	15	Al	CN	1		
	294A25/L6AN	22	37	15	Al	CN	1		
	294A30/L6AN	27	42	15	Al	CN	1		
	294A35/L6AN	32	47	15	Al	CN	1		
	294A25/6U	18	33	15	Al	CN	1		
	294A30/6U	23	38	15	Al	CN	1		
	294A35/6U	28	43	15	Al	CN	1		

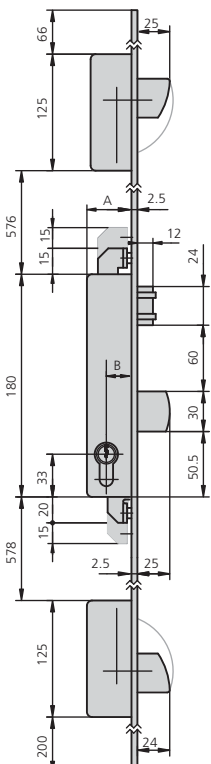
 <ul style="list-style-type: none"> <li>Rodillo vaivén regulable y palanca</li> <li>Cilindro europerfil de seguridad leva DIN</li> </ul> <p><b>Cerraderos de serie</b></p> <ul style="list-style-type: none"> <li>Central fijo inox: CE196/6L ó CE196/6LAN</li> <li>2 unidades alto/bajo fijo inox: CE296S/6L ó CE296S/6LAN</li> </ul> <p><b>Otras opciones de cerradero</b> (ver página 41 - 47)</p>									
	294V25/6L	22	37	15	Al	CN	1		
	294V30/6L	27	42	15	Al	CN	1		
	294V35/6L	32	47	15	Al	CN	1		
	294V25/6LAN	22	37	15	Al	CN	1		
	294V30/6LAN	27	42	15	Al	CN	1		
	294V35/6LAN	32	47	15	Al	CN	1		
	294V25/6U	18	33	15	Al	CN	1		
	294V30/6U	23	38	15	Al	CN	1		
	294V35/6U	28	43	15	Al	CN	1		

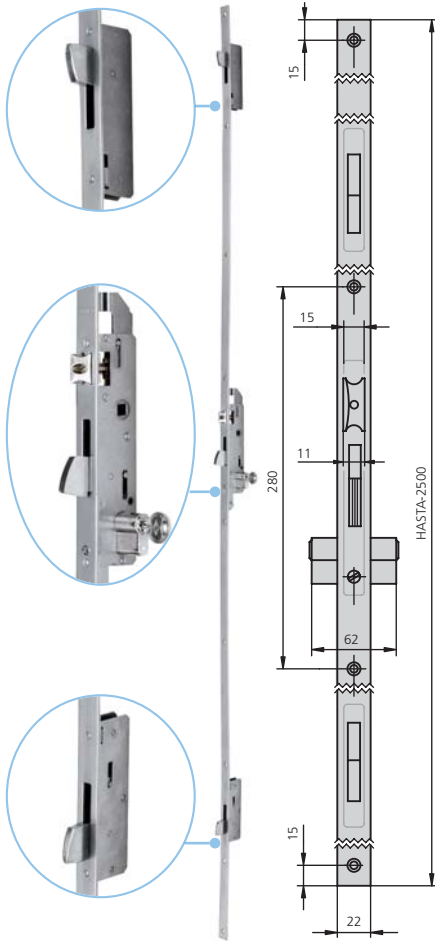

**MULTIPUNTO FRENTE ESPECIAL PALANCA BASCULANTE ENTRE EJES 92 mm.**
**SERIE 494**

**CARACTERÍSTICAS**

- Frente liso inox de 22mm ó 24 mm de ancho ó frente de U de 24,5x6mm y hasta 2500 mm de alto
- Picaporte reversible de 11mm
- Picaporte regulable excepto en entrada 25mm
- Caja zincada de 15mm
- Cuadradillo de 8mm
- Escudo de seguridad pasante ref. BTI296/1N
- Cerraderos de serie según cerradura
- Tornillo de fijación de cilindro

**ACCESORIOS OPCIONALES**

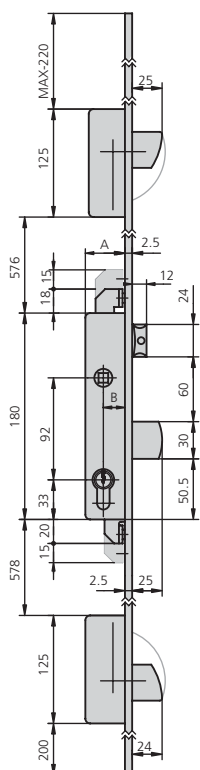
- Otros cerraderos según cerradura (ver abajo)
- Gama completa de cilindros de seguridad (ver página 136 - 141)

**DESCRIPCIÓN**
**REF.**
**MEDIDAS**
**LEVA**
**ACABADOS**
**UDS**
**PRECIO**
**B**
**A**
**FRENTE**
**CILINDRO**
**COMPLETA S/CILINDRO**

- Picaporte y palanca
- Cilindro europerfil de seguridad leva DIN

**Cerraderos de serie**

- Central fijo inox: CE196/6L ó CE196/6LAN
- 2 unidades alto/bajo fijo inox: CE296S/6L ó CE296S/6LAN

**Otras opciones de cerradero (ver página 41 - 47)**
**Opción cerradero eléctrico**

- CEC41/6A ó CEC41/6AD

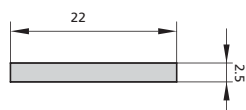

494/25/6L	22	37	15	Al	CN	1		
494/30/6L	27	42	15	Al	CN	1		
494/35/6L	32	47	15	Al	CN	1		



494/25/6LAN	22	37	15	Al	CN	1		
494/30/6LAN	27	42	15	Al	CN	1		
494/35/6LAN	32	47	15	Al	CN	1		

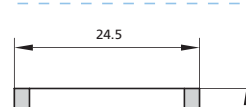

494/25/6U	18	33	15	Al	CN	1		
494/30/6U	23	38	15	Al	CN	1		
494/35/6U	28	43	15	Al	CN	1		

## MULTIPUNTO FRENTE ESPECIAL PALANCA BASCULANTE ENTRE EJES 92 mm.



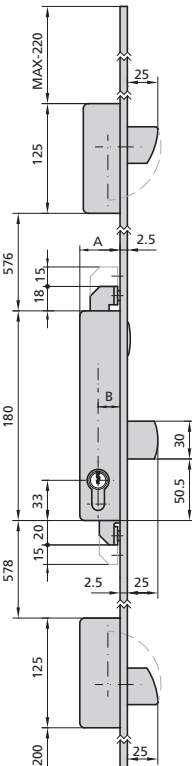
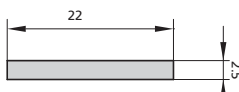
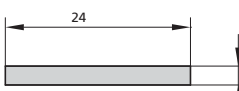
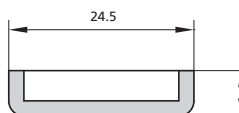

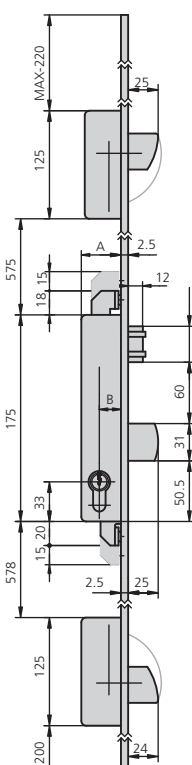
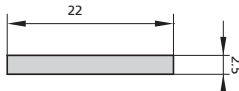
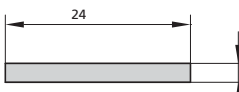
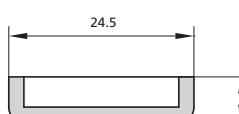







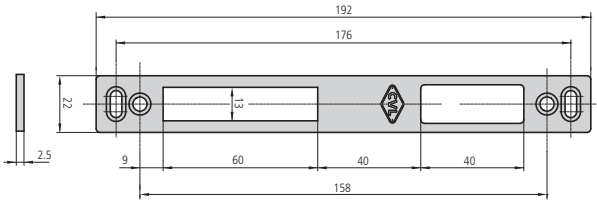

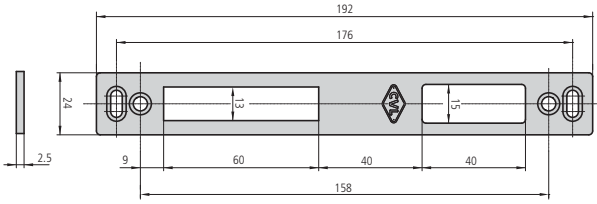
## SERIE 494

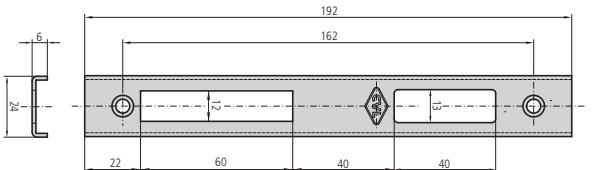
DESCRIPCIÓN	REF.	MEDIDAS		LEVA	ACABADOS		UDS	PRECIO	
		B	A		FRENTE	CILINDRO		COMPLETA	S/CILINDRO
 <ul style="list-style-type: none"> <li>Solo palanca</li> <li>Cilindro 6982/2535/4</li> </ul> <p><b>Cerraderos de serie</b></p> <ul style="list-style-type: none"> <li>3 unidades alto/bajo</li> <li>fijo inox: CE296S/6L ó CE296S/6LAN</li> </ul> <p><b>Otras opciones de cerradero</b> (ver página 41 - 47)</p>		494A25/6L 22 37 15 AI CN 1 494A30/6L 27 42 15 AI CN 1 494A35/6L 32 47 15 AI CN 1							
		494A25/6LAN 22 37 15 AI CN 1 494A30/6LAN 27 42 15 AI CN 1 494A35/6LAN 32 47 15 AI CN 1							
		494A25/6U 18 33 15 AI CN 1 494A30/6U 23 38 15 AI CN 1 494A35/6U 28 43 15 AI CN 1							

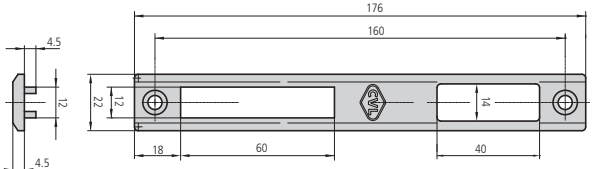

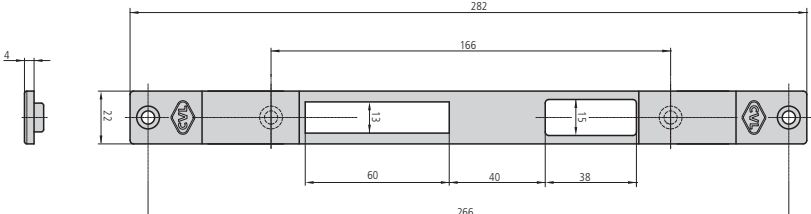

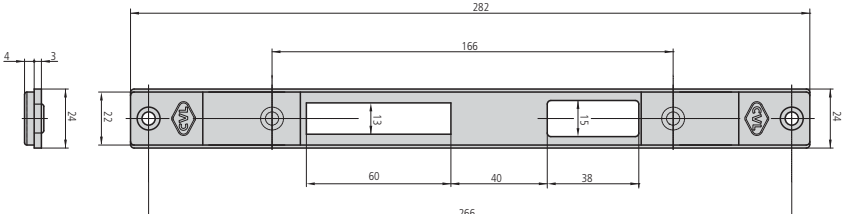







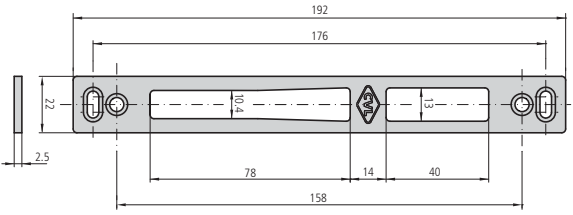

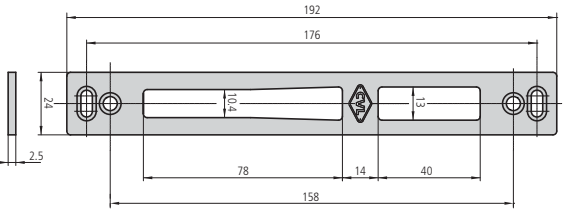

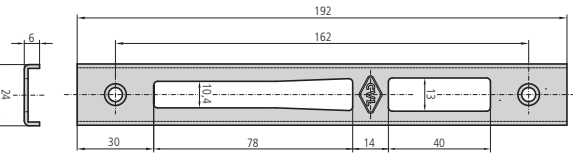
 <ul style="list-style-type: none"> <li>Rodillo vaivén regulable y palanca</li> <li>Cilindro europerfil de seguridad leva DIN</li> </ul> <p><b>Cerraderos de serie</b></p> <ul style="list-style-type: none"> <li>Central fijo inox: CE196/6L ó CE196/6LAN</li> <li>2 unidades alto/bajo</li> <li>fijo inox: CE296S/6L ó CE296S/6LAN</li> </ul> <p><b>Otras opciones de cerradero</b> (ver página 41 - 47)</p>		494V25/6L 22 37 15 AI CN 1 494V30/6L 27 42 15 AI CN 1 494V35/6L 32 47 15 AI CN 1						
		494V25/6LAN 22 37 15 AI CN 1 494V30/6LAN 27 42 15 AI CN 1 494V35/6LAN 32 47 15 AI CN 1						
		494V25/6U 18 33 15 AI CN 1 494V30/6U 23 38 15 AI CN 1 494V35/6U 28 43 15 AI CN 1						

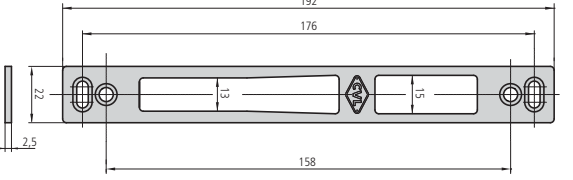



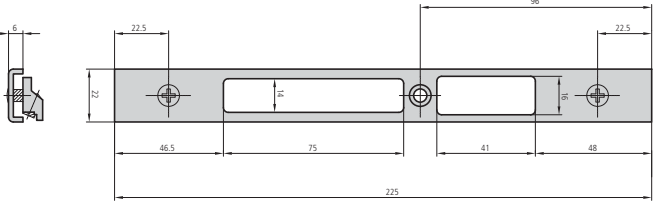

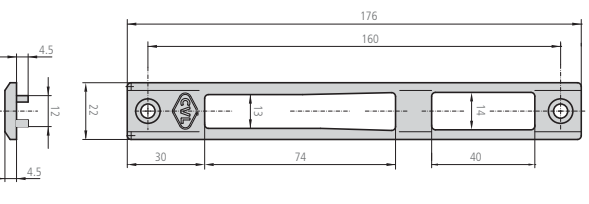





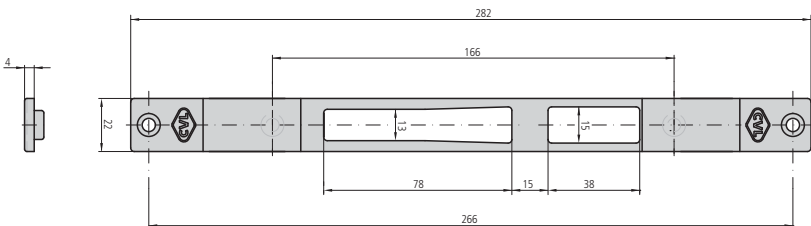

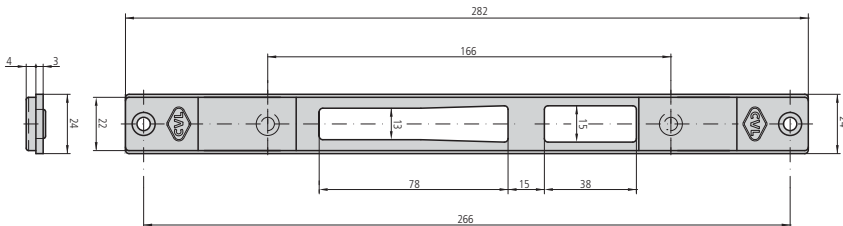
## ACCESORIOS

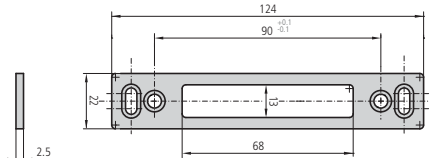
## CERRADEROS

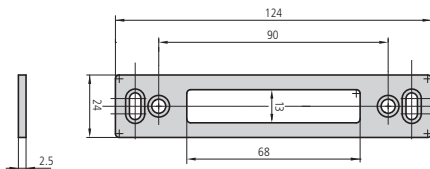
DESCRIPCIÓN	REF.	APLICABLE A CERRADURAS	UDS  	PRECIO COMPLETA S/CILINDRO
	CE184/0L			 
<ul style="list-style-type: none"> <li>Cerradero fijo de hierro niquelado</li> </ul>				
<ul style="list-style-type: none"> <li>Cerradero fijo de acero inoxidable</li> </ul>	CE184/6L			
	CE184/0LAN			 
<ul style="list-style-type: none"> <li>Cerradero fijo de hierro niquelado</li> </ul>				
<ul style="list-style-type: none"> <li>Cerradero fijo de acero inoxidable</li> </ul>	CE184/6LAN			
	CE184/6U			 
<ul style="list-style-type: none"> <li>Cerradero fijo de acero inoxidable</li> </ul>		184, 184C, 184V, 192, 192C, 192V, 1E5, 2E5, 1E2, 2E2		
	CE184/1N			 
<ul style="list-style-type: none"> <li>Cerradero fijo metálico negro</li> </ul>				
	CE184/1NR			 
<ul style="list-style-type: none"> <li>Cerradero regulable metálico negro</li> </ul>				
	CE184/1NRS			 
<ul style="list-style-type: none"> <li>Cerradero regulable metálico negro con suplemento</li> </ul>				

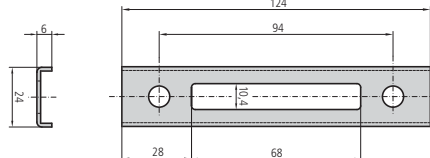

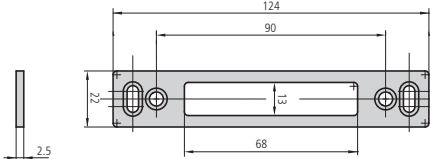
**ACCESORIOS** **CERRADEROS**



DESCRIPCIÓN	REF.	APLICABLE A CERRADURAS	UDS 	PRECIO  COMPLETA S/CILINDRO
	CE196/6L			 
	CE196/6LAN			 
	CE196/6U	196, 196C, 196V, 197, 194, 194C, 194V, 296, 296V, 496, 496V, 596, 596V, 294, 294V, 494, 494V, 184, 184C, 184V, 192, 192C, 192V		 
				
	CE196/6LR			 
	CE196/6RU			 
	CE196/1N			 

DESCRIPCIÓN	REF.	APLICABLE A CERRADURAS	UDS 	PRECIO 
				COMPLETA S/CILINDRO
				
<ul style="list-style-type: none"> <li>Cerradero regulable metálico negro</li> </ul>	CE196/1NR	196, 196C, 196V, 197, 194, 194C, 194V, 296, 296V, 496, 496V, 596, 596V, 294, 294V, 494, 494V, 184, 184C, 184V, 192, 192C, 192V		
				
<ul style="list-style-type: none"> <li>Cerradero regulable metálico negro con suplemento</li> </ul>	CE196/1NRS			
				
<ul style="list-style-type: none"> <li>Cerradero fijo de acero inoxidable para solo palanca</li> </ul>	CE296S/6L			
				
<ul style="list-style-type: none"> <li>Cerradero fijo de acero inoxidable para solo palanca</li> </ul>	CE296S/6LAN	184A, 196A, 197K, 296A, 496A, 596A, 294A, 494A, suplementos alto/bajo de las series 296, 496, 596, 294, 494, 2E5, 2E2, 2K5		
				
<ul style="list-style-type: none"> <li>Cerradero fijo de acero inoxidable para solo palanca</li> </ul>	CE296S/6U			
				
<ul style="list-style-type: none"> <li>Cerradero regulable de acero inoxidable con levas</li> </ul>	CE296S/6LR			

## ACCESORIOS

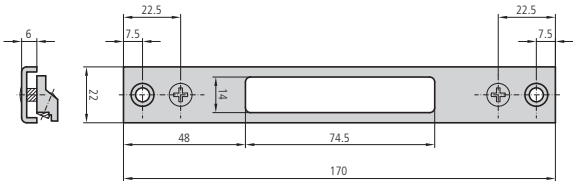
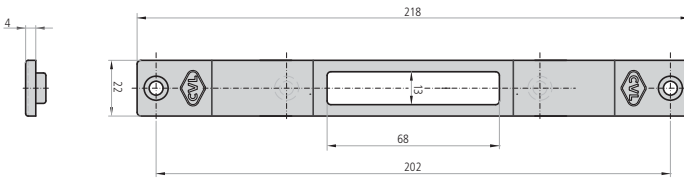
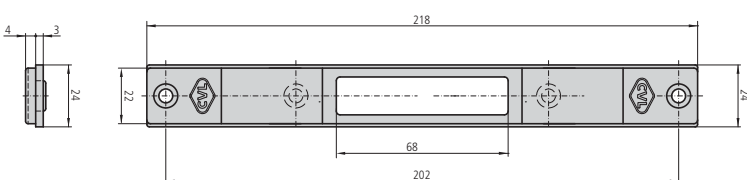
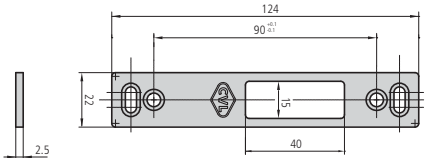
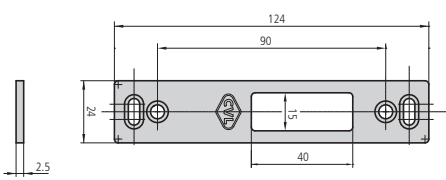
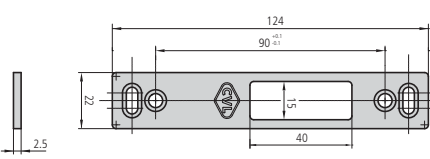
## CERRADEROS

DESCRIPCIÓN	REF.	APLICABLE A CERRADURAS	UDS 	PRECIO 
			COMPLETA	S/CILINDRO
				
• Cerradero regulable inox en U solo palanca	CE296S/6RU			
		184A, 196A, 197K, 296A, 496A, 596A, 294A, 494A, suplementos alto/bajo de las series 296, 496, 596, 294, 494, 2E5, 2E2, 2K5		
• Cerradero regulable metálico negro	CE296S/1NR			
				
• Cerradero regulable metálico negro con suplemento	CE296S/1NRS			
				
• Cerradero fijo de acero inoxidable para solo picaporte	CE196R/6L			
		196R, 196RV, 196T, 194T		
• Cerradero fijo de acero inoxidable para solo picaporte	CE196R/6LAN			
				
• Cerradero regulable de acero inoxidable con levas	CE196R/6LR			

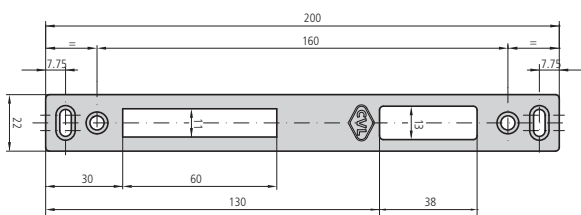
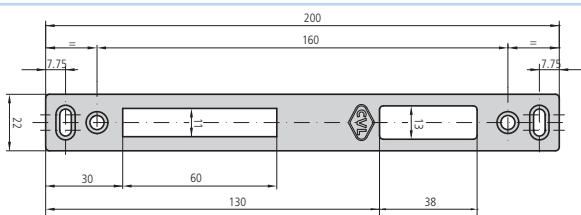
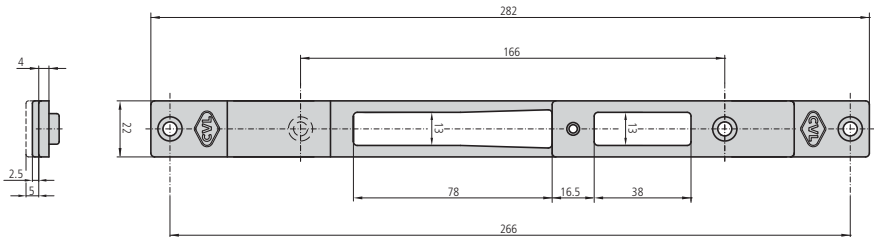
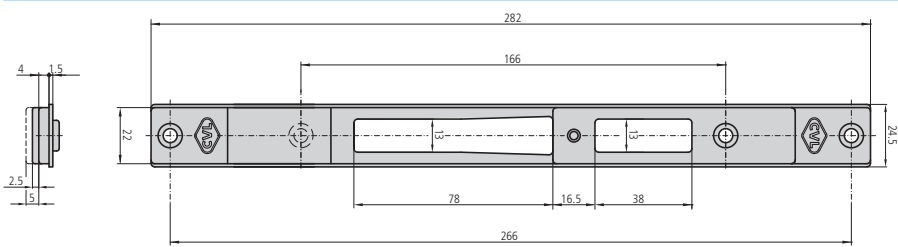
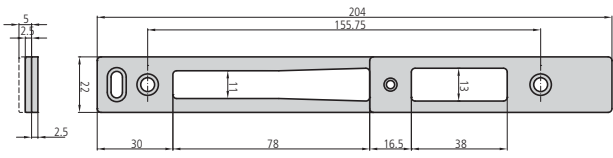
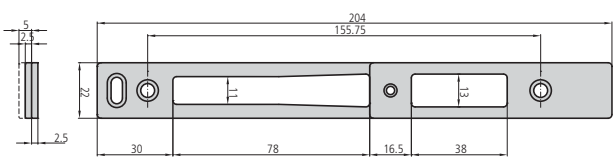
DESCRIPCIÓN	REF.	APLICABLE A CERRADURAS	UDS 	PRECIO 
				COMPLETA S/CILINDRO
	CE1E5/6L	1E5, central 2E5, 1E2, central 2E2		
<ul style="list-style-type: none"> <li>Cerradero fijo de acero inoxidable de 22 mm.</li> </ul>				
	CE1E5/6LR	1E5, central 2E5, 1E2, central 2E2		
<ul style="list-style-type: none"> <li>Cerradero regulable de acero inoxidable de 22mm. con levas</li> </ul>				
	KCE1K5/1NR	1K5, central 2K5		
<ul style="list-style-type: none"> <li>Cerradero regulable metálico negro, incluye 1 suplemento de 2,5mm y otro de 5mm</li> </ul>				
	KCE1K5/1NRS	1K5, central 2K5		
<ul style="list-style-type: none"> <li>Cerradero regulable metálico negro con suplemento, incluye 1 suplemento de 2,5mm y otro de 5mm</li> </ul>				
	KCE1K5/6L	1K5, central 2K5		
<ul style="list-style-type: none"> <li>Cerradero fijo de acero inoxidable de 22mm, incluye 1 suplemento de 2,5mm y otro de 5mm</li> </ul>				
	KCE1K5/6LR	1K5, central 2K5		
<ul style="list-style-type: none"> <li>Cerradero regulable de acero inoxidable, incluye 1 suplemento de 2,5mm y otro de 5mm con levas</li> </ul>				



**ACCESORIOS**

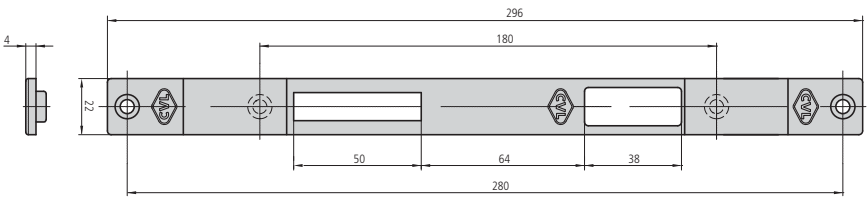

**CERRADEROS**

DESCRIPCIÓN	REF.	APLICABLE A CERRADURAS	UDS 	PRECIO COMPLETA S/CILINDRO 
-------------	------	------------------------	-----------------------------------------------------------------------------------------	----------------------------------------------------------------------------------------------------------------

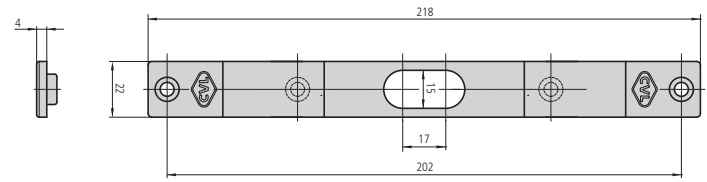

- Cerradero regulable metálico negro      CE202/1NR      202, 302       



- Cerradero regulable metálico negro      CE202S/1NR      Alto/bajo 202       

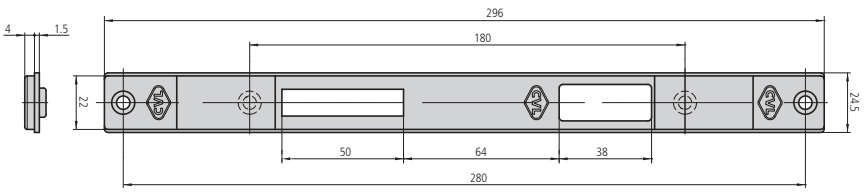

- Cerradero regulable metálico negro con suplemento      CE202/1NRS      202, 302       

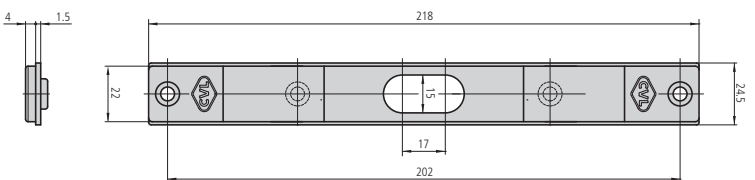

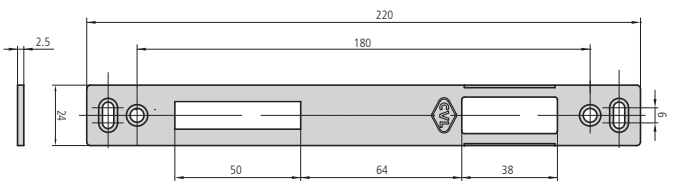

- Cerradero regulable metálico negro con suplemento      CE202S/1NRS      Alto/bajo 202       



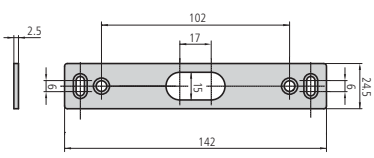

- Cerradero fijo de acero inoxidable de 24mm      CE202/6LAN      202, 302       







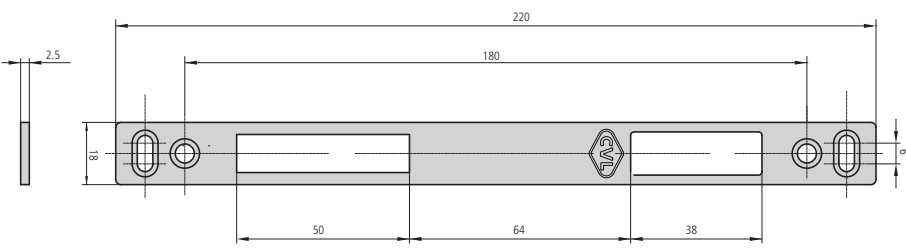
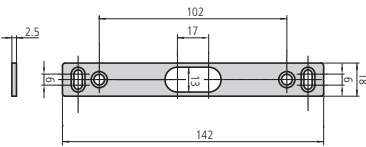
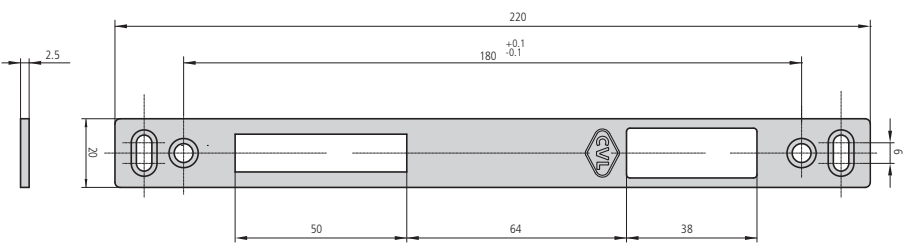
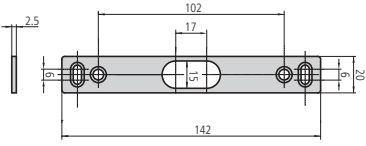
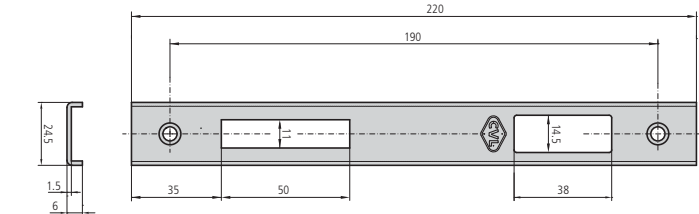
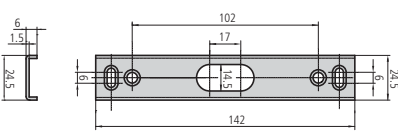





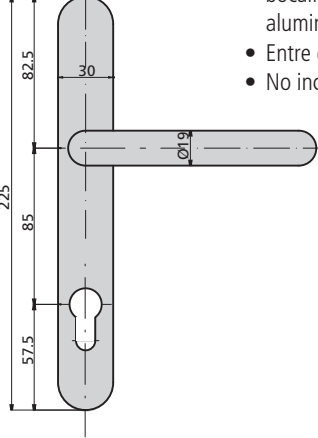



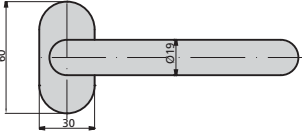

- Cerradero fijo de acero inoxidable de 24mm      CE202S/6LAN      Alto/bajo 202       

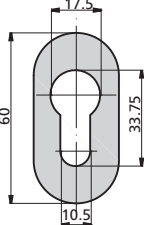
**ACCESORIOS**
**CERRADEROS**

DESCRIPCIÓN	REF.	APLICABLE A CERRADURAS	UDS 	PRECIO 
				COMPLETA S/CILINDRO
	CE202/6LR18	202, 302		
	CE202S/6LR18	Alto/bajo 202		
	CE202/6LR20	202, 302		
	CE202S/6LR20	Alto/bajo 202		
	CE202/6U	202, 302		
	CE202S/6U	Alto/bajo 202		

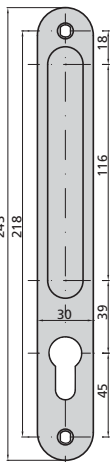
## ACCESORIOS

## ESCUDOS Y MANILLAS DE ACERO INOXIDABLE

DESCRIPCIÓN	REF.	ACABADO	CANTO SERIES	UDS 	PRECIO COMPLETA S/CILINDRO
<ul style="list-style-type: none"> <li>• Escudo con manilla y bocallave cilindro para aluminio</li> <li>• Entre ejes 85mm</li> <li>• No incluye cilindro</li> </ul>  	JM6006/85/6R	Al	Red	2	 
<ul style="list-style-type: none"> <li>• Roseta para aluminio</li> </ul>  	JM6000/6R	Al	Red	2	 
<ul style="list-style-type: none"> <li>• Escudo para cilindro</li> </ul>  	JES6000/6R	Al	Red	2	 
<ul style="list-style-type: none"> <li>• Placa con tirador y bocallave de cilindro</li> <li>• No incluye cilindro</li> </ul>  	JT6006/85/6R	Al	Red	2	 

**ACCESORIOS**
**ESCUDOS**

DESCRIPCIÓN	REF.	ACABADO	CANTO SERIES	UDS	PRECIO	
					COMPLETA	S/CILINDRO
<ul style="list-style-type: none"> <li>Escudo de seguridad no pasante, 1 escudo de nylon y 2 tornillos</li> </ul>	BTI94/1N	NEGRO	183, 184, 192			
	BTI94/1NM	NIQUEL MATE				
	BTI94/1PL	PLATA				
<ul style="list-style-type: none"> <li>Escudo de seguridad pasante con contraescudo, capucha de nylon y dos tornillos pasantes</li> </ul>	BTI296/1N	NEGRO	196, 197, 296,			
	BTI296/1NM	NIQUEL MATE	496, 596, 194,			
	BTI296/1PL	PLATA	294, 494			
<ul style="list-style-type: none"> <li>Escudo de nylon</li> </ul>	ES1984	NEGRO	183, 184, 192, 196, 197, 296, 496, 596, 194, 294, 494			

**ACCESORIOS**
**OTROS**

DESCRIPCIÓN	REF.	APLICABLE A SERIES	UDS	PRECIO	
				COMPLETA	S/CILINDRO
<ul style="list-style-type: none"> <li>Terminales de nylon</li> </ul>	EMB196	184, 192, 196, 197, 194, 1E5, 1E2, 1K5	10		
<ul style="list-style-type: none"> <li>Conjunto vaivén para la serie SOFT</li> </ul>	CV1E5	1E5, 2E5, 1E2, 2E2	10		
<ul style="list-style-type: none"> <li>Tapa resbalón para la serie SOFT</li> </ul>	TAP1E5	1E5, 2E5, 1E2, 2E2	10		



## CERRADURAS DE EMBUTIR PARA CARPINTERÍA METÁLICA



Palanca deslizante entre ejes 85 cilindro europerfil leva corta	52
• Serie 1984	52
Palanca deslizante entre ejes 85 cilindro europerfil leva larga	54
• Serie 1995	54
Palanca gancho entre ejes 85 cilindro europerfil	56
• Serie 190	56
• Serie 1990	57
• Serie 1994	58
Multipunto palanca gancho entre ejes 85	60
• Serie 2994	60
Multipunto palanca gancho entre ejes 85	62
• Serie 3994	62
Palanca deslizante entre ejes 92 cilindro europerfil	64
• Serie 1992	64
Palanca deslizante entre ejes 70 cilindro europerfil	65
• Serie 1983	65
Palanca deslizante entre ejes 85 cilindro ovalado monoblock	67
• Serie 1963	67
• Serie 1975	69
Palanca deslizante entre ejes 74 cilindro ovalado de vástagos	70
• Serie 1964	70
Cerradura para puertas de zócalo con cilindro ovalado de vástagos	72
• Serie 1981	72
Cerradura para puertas de zócalo con cilindro europerfil	73
• Serie 1991	73
Cerradura de sólo gancho con cilindro ovalado de vástagos	74
• Serie 1968	74
Cerradura de sólo gancho con cilindro europerfil	75
• Serie 1982	75
Cerradura de sólo picaporte para puertas metálicas	76
• Serie 1979	76
Cerradura para puertas y persianas metálicas enrollables	77
• Serie 11A	77
• Serie 11E	78
Cerradura para puertas metálicas basculantes	79
• Serie 11B	79
Accesorios	80
• Cerraderos para cerraduras metálicas	80
• Cerraderos eléctricos	83
• Escudos	84
• Escudos de seguridad	84

**PALANCA DESLIZANTE ENTRE EJES 85 CILINDRO EUROPERFIL LEVA CORTA**

**SERIE 1984**

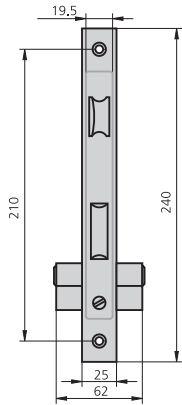

**CARACTERÍSTICAS**

- Frente hierro niquelado ó acero inoxidable
- Caja bicromatada
- Palanca deslizante
- Picaporte reversible
- Cuadradillo de 8mm
- Cilindro europerfil
- 2 escudos de nylon ref. ES1984
- Tornillo de fijación de cilindro

**ACCESORIOS OPCIONALES**

- Cerraderos según cerradura (ver abajo)
- Amplia gama de cilindros (ver página 127 - 148)

DESCRIPCIÓN	REF.	MEDIDAS		LEVA	ACABADOS		UDS		PRECIO	
		B	A		FRENTE	CILINDRO			COMPLETA	S/CILINDRO

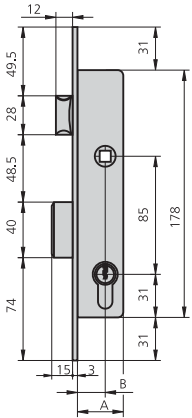

- Picaporte y palanca
- Cilindro 5990/2525

**Opciones de cerradero**

- CE1984/0 ó CE1984/6

**Opción cerraderos eléctricos**

- CEC41/6A
- CEC41/6AD

1984/20/0	20	33	13,25	HN	CN	1	20		
1984/20/5	20	33	13,25	HN	CL	1	20		
1984/20/6	20	33	13,25	AI	CN	1	20		
1984/25/0	25	38	13,25	HN	CN	1	20		
1984/25/5	25	38	13,25	HN	CL	1	20		
1984/25/6	25	38	13,25	AI	CN	1	20		
1984/30/0	30	43	13,25	HN	CN	1	20		
1984/30/5	30	43	13,25	HN	CL	1	20		
1984/30/6	30	43	13,25	AI	CN	1	20		

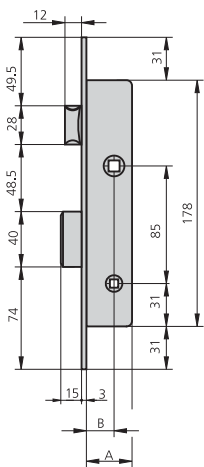

- Cerradura de condena
- Sin cilindro

**Opciones de cerradero**

- CE1984/6

1984C20/6	20	33		AI		2	40		
1984C25/6	25	38		AI		2	40		
1984C30/6	30	43		AI		2	40		



DESCRIPCIÓN	REF.	MEDIDAS		LEVA	ACABADOS		UDS		PRECIO	
		B	A		FRENTE	CILINDRO			COMPLETA	S/CILINDRO
<ul style="list-style-type: none"> <li>Sólo picaporte</li> <li>Cilindro 5982T40/4</li> </ul> <p><b>Opción cerraderos eléctricos</b></p> <ul style="list-style-type: none"> <li>CEC41/6A</li> <li>CEC41/6AD</li> </ul>	1984T20/6	20	33	15	Al	CN	1	20		
	1984T25/6	25	38	15	Al	CN	1	20		
	1984T30/6	30	43	15	Al	CN	1	20		

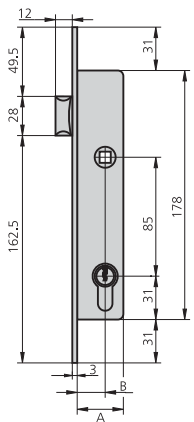

<ul style="list-style-type: none"> <li>Rodillo vaivén regulable y palanca</li> <li>Cilindro 5990/2525</li> </ul> <p><b>Opciones de cerradero</b></p> <ul style="list-style-type: none"> <li>CE1984/6</li> </ul>	1984V20/6	20	33	13,25	Al	CN	1	20		
	1984V25/6	25	38	13,25	Al	CN	1	20		
	1984V30/6	30	43	13,25	Al	CN	1	20		

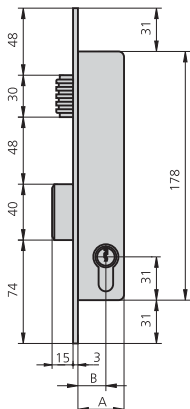

**PALANCA DESLIZANTE ENTRE EJES 85 CILINDRO EUROPERFIL LEVA LARGA**

**SERIE 1995**

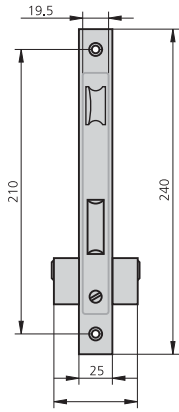

**CARACTERÍSTICAS**

- Frente hierro niquelado ó acero inoxidable
- Caja bicromatada
- Palanca deslizante
- Picaporte reversible
- Cudradillo de 8mm
- Cilindro europerfil
- 2 escudos de nylon ref. ES1984
- Tornillo de fijación de cilindro

**ACCESORIOS OPCIONALES**

- Cerraderos según cerradura (ver abajo)
- Amplia gama de cilindros (ver página 127 - 148)

DESCRIPCIÓN	REF.	MEDIDAS		LEVA	ACABADOS		UDS		PRECIO	
		B	A		FRENTE	CILINDRO			COMPLETA	S/CILINDRO

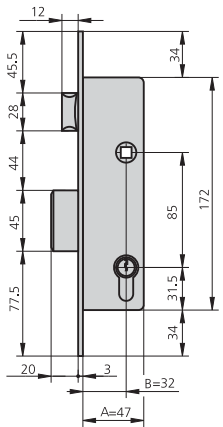

- Picaporte y palanca
- Cilindro 5982/2525

**Opciones de cerradero**  
 • CE1984/0 ó CE1984/6

**Opciones cerraderos eléctricos**  
 • CEC41/6A  
 CEC41/6AD

1995/32/0	32	47	15	HN	CN	1	20		
1995/32/5	32	47	15	HN	CL	1	20		
1995/32/6	32	47	15	Al	CN	1	20		

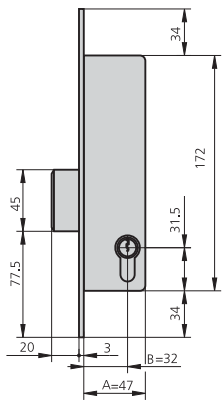

- Sólo palanca
- Cilindro 5982/2525/4

**Opciones de cerradero**  
 • CE2994S/6

1995A32/6	32	47	15	Al	CN	1	20		
-----------	----	----	----	----	----	---	----	--	--

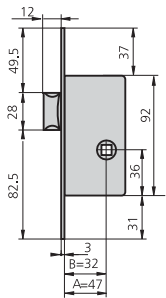

- Sólo picaporte
- Sin cilindro

1995R32/0	32	47		HN		1	30		
-----------	----	----	--	----	--	---	----	--	--

**PALANCA DESLIZANTE ENTRE EJES 85 CILINDRO EUROPERFIL LEVA LARGA SERIE 1995**

DESCRIPCIÓN	REF.	MEDIDAS		LEVA	ACABADOS		UDS		PRECIO	
		B	A		FRENTE	CILINDRO			COMPLETA	S/CILINDRO

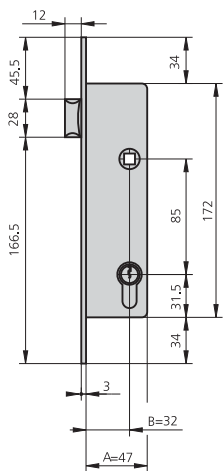

- Sólo picaporte
- Cilindro 5982T40/4

**Opciones cerraderos eléctricos**

- CEC41/6A
- CEC41/6AD

1995T32/6	32	47	15	Al	CN	1	20		
-----------	----	----	----	----	----	---	----	--	--

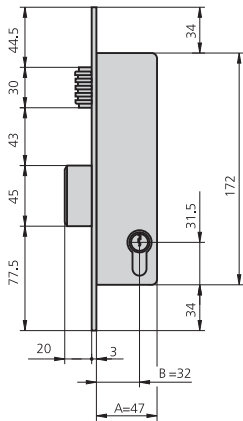

- Rodillo vaivén regulable y palanca
- Cilindro 5982/2525/4

**Opciones de cerradero**

- CE1984/6

1995V32/6	32	47	15	Al	CN	1	20		
-----------	----	----	----	----	----	---	----	--	--

**PALANCA GANCHO ENTRE EJES 85 CILINDRO EUROPERFIL**

**SERIE 190**

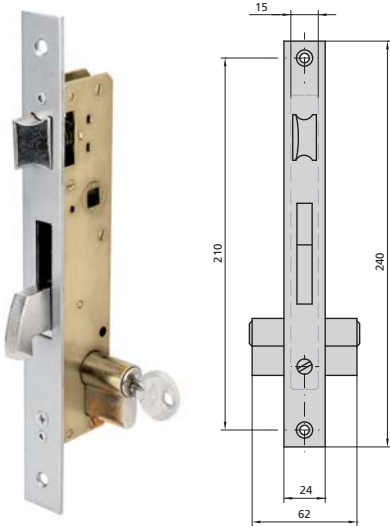

**CARACTERÍSTICAS**

- Frente de 24 mm
- Picaporte reversible
- Caja bicromatada de 15 mm
- Cudradillo de 8mm
- Cilindro europerfil
- 2 escudos de nylon ref. ES1984
- Tornillo de fijación de cilindro

**ACCESORIOS OPCIONALES**

- Amplia gama de cilindros (ver página 127 - 148)

DESCRIPCIÓN	REF.	MEDIDAS		LEVA	ACABADOS		UDS		PRECIO	
		B	A		FRENTE	CILINDRO			COMPLETA	S/CILINDRO

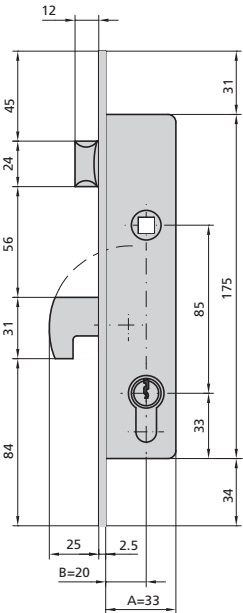

- Picaporte y palanca
- Cilindro 5990/2525

- Opciones de cerradero**
- CE190/0 ó CE190/6

190/23/0	20	33	13,25	HN	CN	1	20		
190/23/5	20	33	13,25	HN	CL	1	20		
190/23/6	20	33	13,25	AI	CN	1	20		
190/28/0	25	38	13,25	HN	CN	1	20		
190/28/5	25	38	13,25	HN	CL	1	20		
190/28/6	25	38	13,25	AI	CN	1	20		
190/33/0	30	43	13,25	HN	CN	1	20		
190/33/5	30	43	13,25	HN	CL	1	20		
190/33/6	30	43	13,25	AI	CN	1	20		

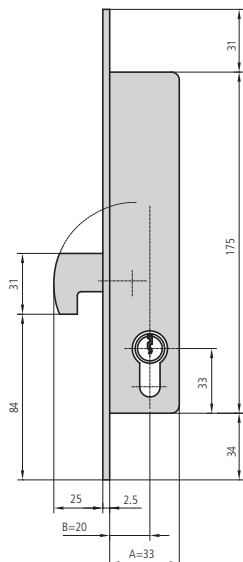

- Solo palanca
- Cilindro 5990/2525

- Opciones de cerradero**
- CE190/0 ó CE190/6

190A23/0	20	33	13,25	HN	CN	1	20		
190A23/5	20	33	13,25	HN	CL	1	20		
190A23/6	20	33	13,25	AI	CN	1	20		
190A28/0	25	38	13,25	HN	CN	1	20		
190A28/5	25	38	13,25	HN	CL	1	20		
190A28/6	25	38	13,25	AI	CN	1	20		
190A33/0	30	43	13,25	HN	CN	1	20		
190A33/5	30	43	13,25	HN	CL	1	20		
190A33/6	30	43	13,25	AI	CN	1	20		

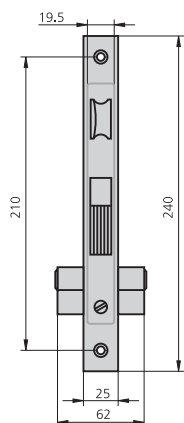
**CARACTERÍSTICAS**

- Frente hierro niquelado ó acero inoxidable
- Caja bicromatada
- Palanca basculante de gancho
- Picaporte reversible
- Cudradillo de 8mm
- Cilindro europerfil
- 2 escudos de nylon ref. ES1984
- Tornillo de fijación de cilindro

**ACCESORIOS OPCIONALES**

- Amplia gama de cilindros (ver página 127 - 148)

DESCRIPCIÓN	REF.	MEDIDAS		LEVA	ACABADOS		UDS		PRECIO	
		B	A		FRENTE	CILINDRO			COMPLETA	S/CILINDRO
<ul style="list-style-type: none"> <li>• Picaporte y palanca</li> <li>• Cilindro 5990/2525 ó 5982/2525</li> <li>• Cerradero CE1990/0</li> </ul>	1990/20/0	20	33	13,25	HN	CN	1	20		
	1990/20/5	20	33	13,25	HN	CL	1	20		
	1990/20/6	20	33	13,25	AI	CN	1	20		
	1990/25/0	25	38	13,25	HN	CN	1	20		
	1990/25/5	25	38	13,25	HN	CL	1	20		
	1990/25/6	25	38	13,25	AI	CN	1	20		
	1990/32/0	32	47	15	HN	CN	1	20		
	1990/32/5	32	47	15	HN	CL	1	20		
1990/32/6	32	47	15	AI	CN	1	20			
<ul style="list-style-type: none"> <li>• Sólo palanca</li> <li>• Cilindro 5990/2525 ó 5982/2525</li> <li>• Cerradero CE1990/0</li> </ul>	1990A20/0	20	33	13,25	HN	CN	1	20		
	1990A20/5	20	33	13,25	HN	CL	1	20		
	1990A20/6	20	33	13,25	AI	CN	1	20		
	1990A25/0	25	38	13,25	HN	CN	1	20		
	1990A25/5	25	38	13,25	HN	CL	1	20		
	1990A25/6	25	38	13,25	AI	CN	1	20		
	1990A32/0	32	47	15	HN	CN	1	20		
	1990A32/5	32	47	15	HN	CL	1	20		
1990A32/6	32	47	15	AI	CN	1	20			
<ul style="list-style-type: none"> <li>• Rodillo vaivén regulable y palanca</li> <li>• Cilindro 5990/2525 ó 5982/2525</li> <li>• Cerradero CE1990/0</li> </ul>	1990V20/0	20	33	13,25	HN	CN	1	20		
	1990V20/5	20	33	13,25	HN	CL	1	20		
	1990V20/6	20	33	13,25	AI	CN	1	20		
	1990V25/0	25	38	13,25	HN	CN	1	20		
	1990V25/5	25	38	13,25	HN	CL	1	20		
	1990V25/6	25	38	13,25	AI	CN	1	20		
	1990V32/0	32	47	15	HN	CN	1	20		
	1990V32/5	32	47	15	HN	CL	1	20		
1990V32/6	32	47	15	AI	CN	1	20			

**PALANCA GANCHO ENTRE EJES 85 CILINDRO EUROPERFIL**

**SERIE 1994**

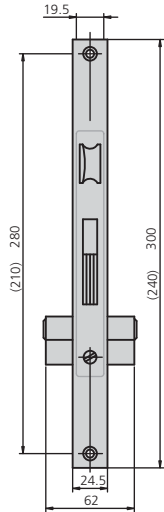

**CARACTERÍSTICAS**

- Frente de acero inoxidable
- Caja bicromatada
- Palanca basculante de gancho
- Picaporte reversible
- Cudradillo de 8mm
- Cilindro europerfil
- Tornillo de fijación de cilindro
- Cerradero según cerradura
- Escudo de seguridad BTI94/1N

**ACCESORIOS OPCIONALES**

- Amplia gama de cilindros (ver página 127 - 148)

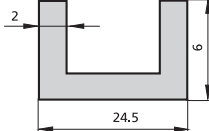

**FRENTE U**

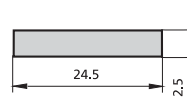

**FRENTE LISO**

DESCRIPCIÓN	REF.	MEDIDAS		LEVA	ACABADOS		UDS		PRECIO	
		B	A		FRENTE	CILINDRO			COMPLETA	S/CILINDRO

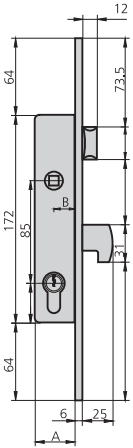

**FRENTE U**

- Picaporte y palanca
- Cilindro 5982/2525/4
- Cerradero CE1994/6
- Escudo de seguridad BTI94/1N

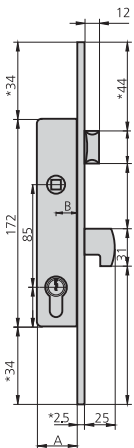

1994/25/6	18	33	15	Al	CN	1	10		
1994/30/6	23	38	15	Al	CN	1	10		
1994/35/6	28	43	15	Al	CN	1	10		



**FRENTE LISO**

- Picaporte y palanca
- Cilindro 5982/2525/4
- Cerradero CE1994/6
- Escudo de seguridad BTI94/1N

1994/25/6L	22	37	15	Al	CN	1	20		
1994/30/6L	27	42	15	Al	CN	1	20		
1994/35/6L	32	47	15	Al	CN	1	20		

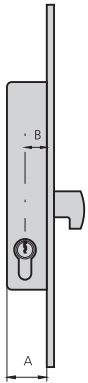
DESCRIPCIÓN	REF.	MEDIDAS		LEVA	ACABADOS		UDS		PRECIO	
		B	A		FRENTE	CILINDRO			COMPLETA	S/CILINDRO
 <b>FRENTE U</b> <ul style="list-style-type: none"> <li>Sólo palanca</li> <li>Cilindro 5982/2525/4</li> <li>Cerradero CE1994/6</li> <li>Escudo de seguridad BTI94/1N</li> </ul>	1994A25/6	18	33	15	Al	CN	1	10		
	1994A30/6	23	38	15	Al	CN	1	10		
	1994A35/6	28	43	15	Al	CN	1	10		
<b>FRENTE LISO</b> <ul style="list-style-type: none"> <li>Sólo palanca</li> <li>Cilindro 5982/2525/4</li> <li>Cerradero CE1994/6</li> <li>Escudo de seguridad BTI94/1N</li> </ul>	1994A25/6L	22	37	15	Al	CN	1	20		
	1994A30/6L	27	42	15	Al	CN	1	20		
	1994A35/6L	32	47	15	Al	CN	1	20		

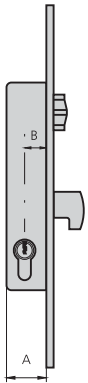
 <b>FRENTE U</b> <ul style="list-style-type: none"> <li>Rodillo vaivén regulable y palanca</li> <li>Cilindro 5982/2525/4</li> <li>Cerradero CE1994/6</li> <li>Escudo de seguridad BTI94/1N</li> </ul>	1994V25/6	18	33	15	Al	CN	1	10		
	1994V30/6	23	38	15	Al	CN	1	10		
	1994V35/6	28	43	15	Al	CN	1	10		
<b>FRENTE LISO</b> <ul style="list-style-type: none"> <li>Rodillo vaivén regulable y palanca</li> <li>Cilindro 5982/2525/4</li> <li>Cerradero CE1994/6</li> <li>Escudo de seguridad BTI94/1N</li> </ul>	1994V25/6L	22	37	15	Al	CN	1	20		
	1994V30/6L	27	42	15	Al	CN	1	20		
	1994V35/6L	32	47	15	Al	CN	1	20		



**MULTIPUNTO PALANCA GANCHO ENTRE EJES 85**

**SERIE 2994**

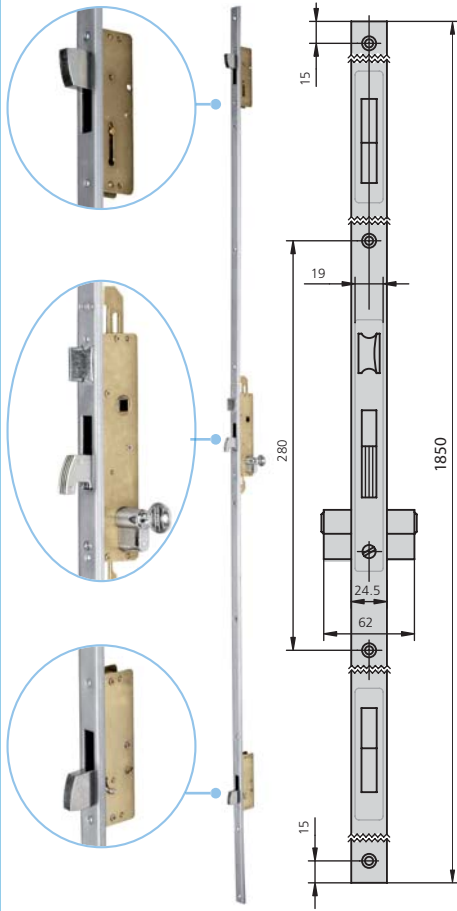

**CARACTERÍSTICAS**

- Frente de acero inoxidable
- Caja bicromatada
- Palanca basculante de gancho
- Picaporte reversible
- Cudradillo de 8mm
- Cilindro euoperfil de seguridad
- Tornillo de fijación de cilindro
- Cerradero según cerradura
- Escudo de seguridad BT194/1N

**ACCESORIOS OPCIONALES**

- Amplia gama de cilindros (ver página 127 - 148)

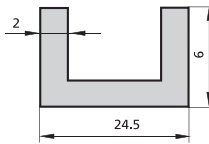

**FRENTE U**



**FRENTE LISO**

DESCRIPCIÓN	REF.	MEDIDAS		LEVA	ACABADOS		UDS		PRECIO	
		B	A		FRENTE	CILINDRO			COMPLETA	S/CILINDRO

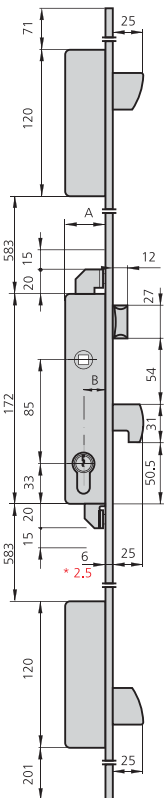

**FRENTE U**

- Picaporte y palanca
- Cilindro 6982/2525/4
- Cerradero CE1994/6
- Cerradero alto/bajo CE2994S/6
- Escudo de seguridad BT194/1N

2994/25/6	18	33	15	Al	CN	1		
2994/30/6	23	38	15	Al	CN	1		
2994/35/6	28	43	15	Al	CN	1		

**FRENTE LISO**

- Picaporte y palanca
- Cilindro 6982/2525/4
- Cerradero CE1994/6
- Cerradero alto/bajo CE2994S/6
- Escudo de seguridad BT194/1N

2994/25/6L	22	37	15	Al	CN	1		
2994/30/6L	27	42	15	Al	CN	1		
2994/35/6L	32	47	15	Al	CN	1		

\* Medidas en frente liso

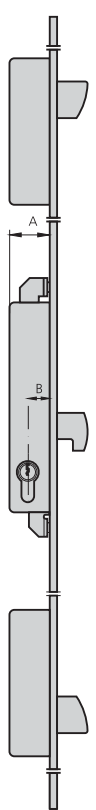
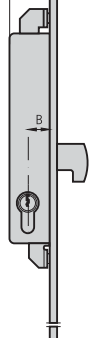
DESCRIPCIÓN	REF.	MEDIDAS		LEVA	ACABADOS		UDS	PRECIO	
		B	A		FRENTE	CILINDRO		COMPLETA	S/CILINDRO
 <p><b>FRENTE U</b></p> <ul style="list-style-type: none"> <li>Sólo palanca</li> <li>Cilindro 6982/2525/4</li> <li>Cerradero CE1994/6</li> <li>Cerradero alto/bajo CE2994S/6</li> <li>Escudo de seguridad BTI94/1N</li> </ul>	2994A25/6	18	33	15	Al	CN	1		
	2994A30/6	23	38	15	Al	CN	1		
	2994A35/6	28	43	15	Al	CN	1		
 <p><b>FRENTE LISO</b></p> <ul style="list-style-type: none"> <li>Sólo palanca</li> <li>Cilindro 6982/2525/4</li> <li>Cerradero CE1994/6</li> <li>Cerradero alto/bajo CE2994S/6</li> <li>Escudo de seguridad BTI94/1N</li> </ul>	2994A25/6L	22	37	15	Al	CN	1		
	2994A30/6L	27	42	15	Al	CN	1		
	2994A35/6L	32	47	15	Al	CN	1		

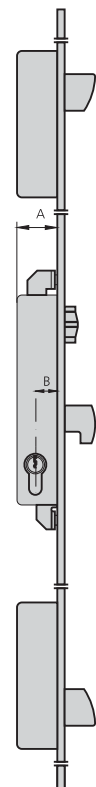
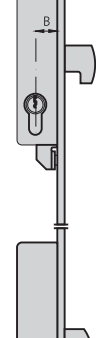
 <p><b>FRENTE U</b></p> <ul style="list-style-type: none"> <li>Rodillo vaivén regulable y palanca</li> <li>Cilindro 6982/2525/4</li> <li>Cerraderos CE1994/6</li> <li>Cerraderos alto/bajo CE2994S/6</li> <li>Escudo de seguridad BTI94/1N</li> </ul>	2994V25/6	18	33	15	Al	CN	1		
	2994V30/6	23	38	15	Al	CN	1		
	2994V35/6	28	43	15	Al	CN	1		
 <p><b>FRENTE LISO</b></p> <ul style="list-style-type: none"> <li>Rodillo vaivén regulable y palanca</li> <li>Cilindro 6982/2525/4</li> <li>Cerraderos CE1994/6</li> <li>Cerraderos alto/bajo CE2994S/6</li> <li>Escudo de seguridad BTI94/1N</li> </ul>	2994V25/6L	22	37	15	Al	CN	1		
	2994V30/6L	27	42	15	Al	CN	1		
	2994V35/6L	32	47	15	Al	CN	1		

## MULTIPUNTO PALANCA GANCHO ENTRE EJES 85

## SERIE 3994

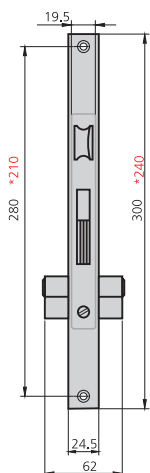

### CARACTERÍSTICAS

- Cerradura de 3 puntos mediante barra roscada de M8
- Frente de acero inoxidable
- Caja bicromatada
- Palanca basculante de gancho
- Picaporte reversible
- Cudradillo de 8mm
- Cilindro de seguridad
- Tornillo de fijación de cilindro
- Cerradero según cerradura
- Escudo de seguridad ref. BTI94/1N

### ACCESORIOS OPCIONALES

- Amplia gama de cilindros (ver página 127 - 148)

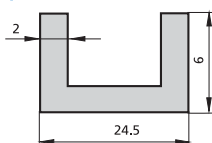

**FRENTE U**

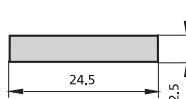

**FRENTE LISO**

\* Medidas en frente liso

DESCRIPCIÓN	REF.	MEDIDAS		LEVA	ACABADOS		UDS		PRECIO	
		B	A		FRENTE	CILINDRO			COMPLETA	S/CILINDRO
<ul style="list-style-type: none"> <li>• Picaporte y palanca</li> <li>• Cilindro 6982/2525/4</li> <li>• Cerradero CE1994/6</li> <li>• Escudo de seguridad BTI94/1N</li> </ul>	3994/25/6	18	33	15	Al	CN	1	10		
	3994/30/6	23	38	15	Al	CN	1	10		
	3994/35/6	28	43	15	Al	CN	1	10		
<ul style="list-style-type: none"> <li>• Picaporte y palanca</li> <li>• Cilindro 6982/2525/4</li> <li>• Cerradero CE1994/6</li> <li>• Escudo de seguridad BTI94/1N</li> </ul>	3994/25/6L	22	37	15	Al	CN	1	10		
	3994/30/6L	27	42	15	Al	CN	1	10		
	3994/35/6L	32	47	15	Al	CN	1	10		

\* Medidas en frente liso

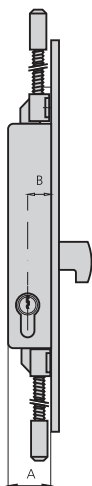

**FRENTE U**

- Sólo palanca
- Cilindro 6982/2525/4
- Cerradero CE1994/6
- Escudo de seguridad BTI94/1N

**FRENTE LISO**

- Cilindro 6982/2525/4
- Cerradero CE1994/6
- Escudo de seguridad BTI94/1N

3994A25/6	18	33	15	Al	CN	1	10		
3994A30/6	23	38	15	Al	CN	1	10		
3994A35/6	28	43	15	Al	CN	1	10		
3994A25/6L	22	37	15	Al	CN	1	10		
3994A30/6L	27	42	15	Al	CN	1	10		
3994A35/6L	32	47	15	Al	CN	1	10		

DESCRIPCIÓN	REF.	MEDIDAS		LEVA	ACABADOS		UDS		PRECIO	
		B	A		FRENTE	CILINDRO			COMPLETA	S/CILINDRO

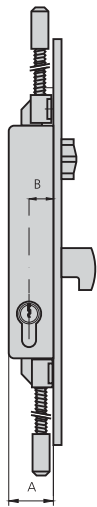

<b>FRENTE U</b>	• Rodillo vaivén regulable y palanca	3994V25/6	18	33	15	Al	CN	1	10		
	• Cilindro 6982/2525/4	3994V30/6	23	38	15	Al	CN	1	10		
	• Cerradero CE1994/6 • Escudo de seguridad BTI94/1N	3994V35/6	28	43	15	Al	CN	1	10		

<b>FRENTE LISO</b>	• Rodillo vaivén regulable y palanca	3994V25/6L	22	37	15	Al	CN	1	10		
	• Cilindro 6982/2525/4	3994V30/6L	27	42	15	Al	CN	1	10		
	• Cerradero CE1994/6 • Escudo de seguridad BTI94/1N	3994V35/6L	32	47	15	Al	CN	1	10		

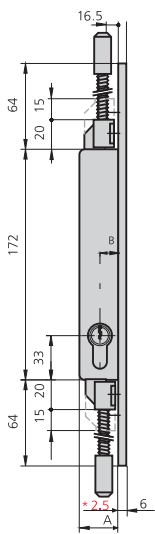

<b>FRENTE U</b>	• Sin palanca y sin picaporte	3994F25/6	18	33	15	Al	CN	1	10		
	• Cilindro 6982/2525/4	3994F30/6	23	38	15	Al	CN	1	10		
	• Escudo de seguridad BTI94/1N	3994F35/6	28	43	15	Al	CN	1	10		

<b>FRENTE LISO</b>	• Sin palanca y sin picaporte	3994F25/6L	22	37	15	Al	CN	1	10		
	• Cilindro 6982/2525/4	3994F30/6L	27	42	15	Al	CN	1	10		
	• Escudo de seguridad BTI94/1N	3994F35/6L	32	47	15	Al	CN	1	10		

## PALANCA DESLIZANTE ENTRE EJES 92 CILINDRO EUROPERFIL

## SERIE 1992

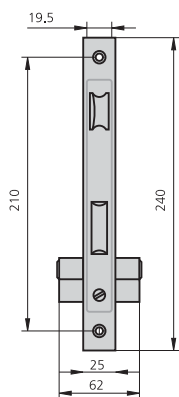

### CARACTERÍSTICAS

- Frente de acero inoxidable
- Caja bicromatada
- Palanca deslizante
- Picaporte reversible
- Cuadradillo de 8mm
- Cilindro europerfil
- 2 escudos de nylon ref. ES1984
- Tornillo de fijación de cilindro

### ACCESORIOS OPCIONALES

- Cerraderos según cerradura (ver abajo)
- Amplia gama de cilindros (ver página 127 - 148)

DESCRIPCIÓN	REF.	MEDIDAS		LEVA	ACABADOS		UDS		PRECIO	
		B	A		FRENTE	CILINDRO			COMPLETA	S/CILINDRO

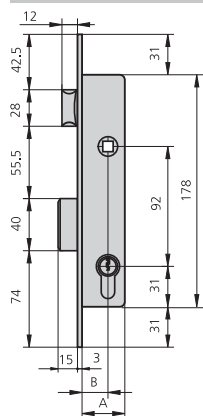

- Picaporte y palanca
- Cilindro 5990/2525/4

1992/20/6	20	33	13,25	Al	CN	1	20		
1992/25/6	25	38	13,25	Al	CN	1	20		
1992/30/6	30	43	13,25	Al	CN	1	20		

#### Opciones de cerradero

- CE1984/6

#### Opciones cerraderos eléctricos

- CELC196/6A ó  
CELC196/6AD

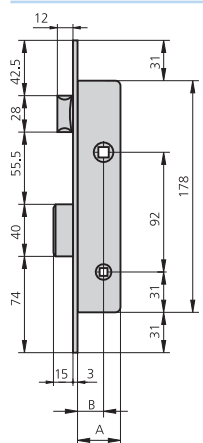

- Cerradura de condena
- Sin cilindro

1992C20/6	20	33		Al		2	40		
1992C25/6	25	38		Al		2	40		
1992C30/6	30	43		Al		2	40		

#### Opciones de cerradero

- CE1984/6

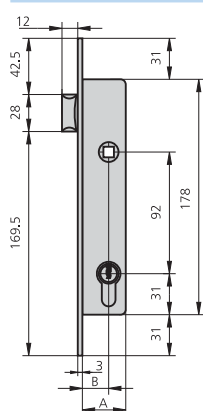

- Sólo picaporte
- Cilindro 5982T40/4

1992T20/6	20	33	15	Al	CN	1	20		
1992T25/6	25	38	15	Al	CN	1	20		
1992T30/6	30	43	15	Al	CN	1	20		

#### Opciones cerraderos eléctricos

- CELC196T/6A ó  
CELC196T/6AD

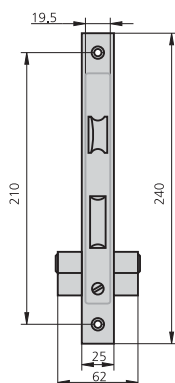

**CARACTERÍSTICAS**

- Frente hierro niquelado ó acero inoxidable
- Caja bicromatada
- Palanca deslizante
- Picaporte reversible
- Cuadradillo de 8mm
- Cilindro europerfil
- 2 escudos de nylon ref. ES1984
- Tornillo de fijación de cilindro

**ACCESORIOS OPCIONALES**

- Cerraderos según cerradura (ver abajo)
- Amplia gama de cilindros (ver página 127 - 148)

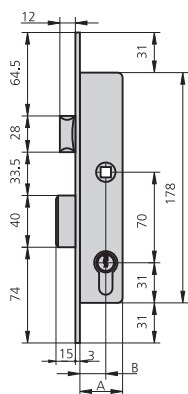
DESCRIPCIÓN	REF.	MEDIDAS		LEVA	ACABADOS		UDS		PRECIO	
		B	A		FRENTE	CILINDRO			COMPLETA	S/CILINDRO



- Picaporte y palanca
- Cilindro 5990/2525
- Opciones de cerradero**
- CE1983/0 ó CE1983/6

1983/20/0	20	33	13,25	HN	CN	1	20		
1983/20/5	20	33	13,25	HN	CL	1	20		
1983/20/6	20	33	13,25	Al	CN	1	20		
1983/25/0	25	38	13,25	HN	CN	1	20		
1983/25/5	25	38	13,25	HN	CL	1	20		
1983/25/6	25	38	13,25	Al	CN	1	20		
1983/30/0	30	43	13,25	HN	CN	1	20		
1983/30/5	30	43	13,25	HN	CL	1	20		
1983/30/6	30	43	13,25	Al	CN	1	20		

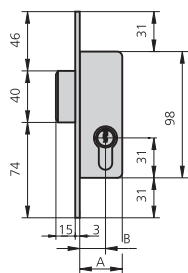

- Sólo palanca
- Cilindro 5990/2525
- Opciones de cerradero**
- CE2994S/6

1983A20/0	20	33	13,25	HN	CN	1	30		
1983A20/5	20	33	13,25	HN	CL	1	30		
1983A25/0	25	38	13,25	HN	CN	1	30		
1983A25/5	25	38	13,25	HN	CL	1	30		
1983A30/0	30	43	13,25	HN	CN	1	30		
1983A30/5	30	43	13,25	HN	CL	1	30		

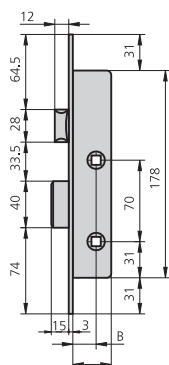



- Cerradura de condena
- Sin cilindro
- Opciones de cerradero**
- CE1983/6

1983C20/6	20	33		Al		2	40		
1983C25/6	25	38		Al		2	40		
1983C30/6	30	43		Al		2	40		

**PALANCA DESLIZANTE ENTRE EJES 70 CILINDRO EUROPERFIL**

**SERIE 1983**

DESCRIPCIÓN	REF.	MEDIDAS		LEVA	ACABADOS		UDS		PRECIO	
		B	A		FRENTE	CILINDRO			COMPLETA	S/CILINDRO
<ul style="list-style-type: none"> <li>• Cerradura de sólo picaporte</li> <li>• Sin cilindro</li> </ul>	1983R20/0	20	33		HN	2	60			
	1983R25/0	25	38		HN	2	60			
	1983R30/0	30	43		HN	2	60			

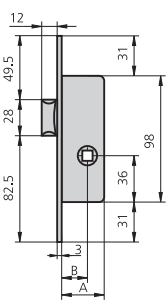

<ul style="list-style-type: none"> <li>• Cerradura de sólo vaivén</li> <li>• Sin cilindro</li> </ul>	1983RV/0		33		HN	2	60		
------------------------------------------------------------------------------------------------------	----------	--	----	--	----	---	----	--	--

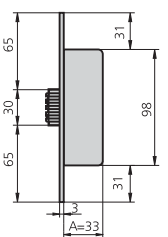

<ul style="list-style-type: none"> <li>• Sólo picaporte</li> <li>• Cilindro 5982T40/4</li> </ul>	1983T20/6	20	33	15	Al	CN	1	20		
	1983T25/6	25	38	15	Al	CN	1	20		
	1983T30/6	30	43	15	Al	CN	1	20		

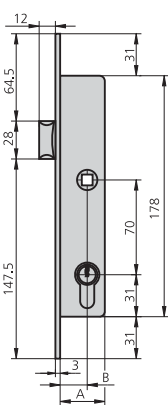

**Opciones de cerraderos eléctricos**

- CELC196T/6A ó CELC196T/6AD



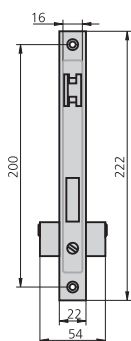

**CARACTERÍSTICAS**

- Frente de hierro niquelado o acero inoxidable
- Caja bicromatada
- Palanca deslizante
- Picaporte reversible
- Cuadradillo de 8mm
- Cilindro ovalado monoblock (5963)
- 2 escudos de nylon ref. ES1963
- Tornillo de fijación de cilindro

**ACCESORIOS OPCIONALES**

- Cerraderos según cerradura (ver abajo)
- Amplia gama de cilindros (ver página 127 - 148)

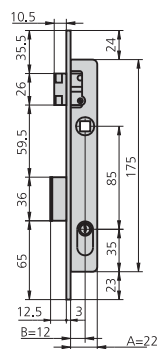
DESCRIPCIÓN	REF.	MEDIDAS		LEVA	ACABADOS		UDS		PRECIO	
		B	A		FRENTE	CILINDRO			COMPLETA	S/CILINDRO



- Picaporte y palanca
  - Cilindro 5963/2222
- Opciones de cerradero**
- CE1984/0 ó CE1984/6

1963/0	12	22	HN	CN	1	20		
1963/5	12	22	HN	CL	1	20		
1963/6	12	22	Al	CN	1	20		

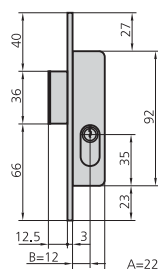

- Cerradura de sólo palanca
  - Cilindro 5963/2222
- Opciones de cerradero**
- CE2994S/6

1963A/0	12	22	HN	CN	1	30		
1963A/5	12	22	HN	CL	1	30		
1963A/6	12	22	Al	CN	1	30		

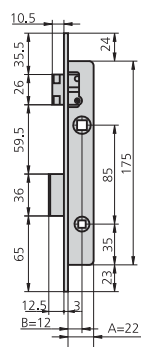

- Cerradura de condena
  - Sin cilindro
- Opciones de cerradero**
- CE1984/6

1963C/6	12	22	Al		2	40		
---------	----	----	----	--	---	----	--	--

**PALANCA DESLIZANTE ENTRE EJES 85 CILINDRO OVALADO MONOBLOCK**

**SERIE 1963**

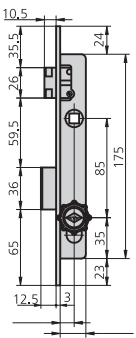
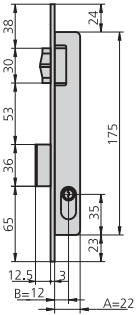
DESCRIPCIÓN	REF.	MEDIDAS		LEVA	ACABADOS		UDS		PRECIO	
		B	A		FRENTE	CILINDRO			COMPLETA	S/CILINDRO
 <ul style="list-style-type: none"> <li>• Cerradura de pomo condensa</li> <li>• Sin cilindro</li> </ul> <p><b>Opciones de cerradero</b></p> <ul style="list-style-type: none"> <li>• CE1984/6</li> </ul>	1963CP16/6	12	22		Al		1	20		
 <ul style="list-style-type: none"> <li>• Cerradura de sólo picaporte</li> <li>• Sin cilindro</li> </ul> <p><b>Opciones de cerradero</b></p> <ul style="list-style-type: none"> <li>• Cerradero CE196R/6</li> </ul>	1963R/0	12	22		HN		2	60		
 <ul style="list-style-type: none"> <li>• Cerradura de sólo vaivén</li> <li>• Sin cilindro</li> </ul> <p><b>Opciones de cerradero</b></p> <ul style="list-style-type: none"> <li>• CE196R/6</li> </ul>	1963RV/0		22		HN		2	60		
 <ul style="list-style-type: none"> <li>• Rodillo vaivén regulable y palanca</li> <li>• Cilindro 5963/2222</li> </ul> <p><b>Opciones de cerradero</b></p> <ul style="list-style-type: none"> <li>• CE1984/0 ó CE1984/6</li> </ul>	1963V/0	12	22		HN	CN	1	20		
	1963V/5	12	22		HN	CL	1	20		
	1963V/6	12	22		Al	CN	1	20		

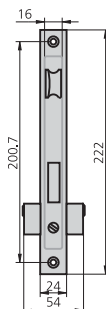

**CARACTERÍSTICAS**

- Frente de hierro niquelado
- Caja bicromatada
- Palanca deslizante
- Picaporte reversible
- Cuadradillo de 8mm
- Cilindro ovalado monoblock (5963)
- 2 escudos de nylon ref. ES1963
- Tornillo de fijación de cilindro

**ACCESORIOS OPCIONALES**

- Cerraderos según cerradura (ver abajo)
- Amplia gama de cilindros (ver página 127 - 148)

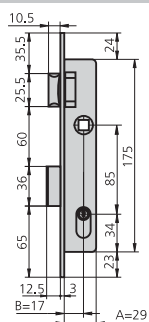
DESCRIPCIÓN	REF.	MEDIDAS		LEVA	ACABADOS		UDS		PRECIO	
		B	A		FRENTE	CILINDRO			COMPLETA	S/CILINDRO



- Picaporte y palanca
- Cilindro 5963/2222

1975/0	17	29	HN	CN	1	20		
1975/5	17	29	HN	CL	1	20		

**Opciones de cerradero**

- CE1984/0

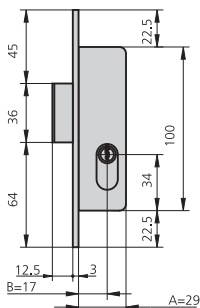

- Cerradura de sólo palanca
- Cilindro 5963/2222

1975A/0	17	29	HN	CN	1	30		
1975A/5	17	29	HN	CL	1	30		

**Opciones de cerradero**

- CE2994S/6

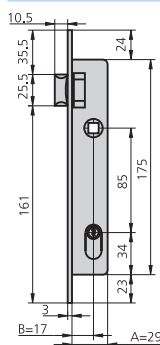

- Cerradura con sólo picaporte
- Cilindro 5963T36

1975T/0	17	29	HN	CN	1	20		
1975T/5	17	29	HN	CL	1	20		

**Opciones de cerraderos eléctricos**

- CEC41T/6A ó CEC41T/6AD

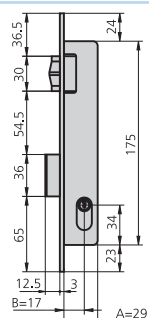

- Rodillo vaivén regulable y palanca
- Cilindro 5963/2222

1975V/0	17	29	HN	CN	1	20		
1975V/5	17	29	HN	CL	1	20		

**Opciones de cerradero**

- CE1984/0

**PALANCA DESLIZANTE ENTRE EJES 74 CILINDRO OVALADO DE VÁSTAGOS**

**SERIE 1964**

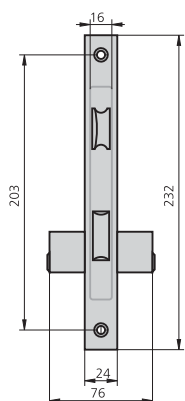

**CARACTERÍSTICAS**

- Frente de hierro niquelado o acero inoxidable
- Caja bicromatada
- Palanca deslizante
- Picaporte reversible
- Cuadradillo de 8mm
- Cilindro ovalado monoblock (5964)
- 2 escudos de nylon ref. ES1964
- Tornillo de fijación de cilindro

**ACCESORIOS OPCIONALES**

- Cerraderos según cerradura (ver abajo)
- Amplia gama de cilindros (ver página 127 - 148)

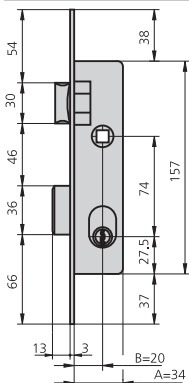
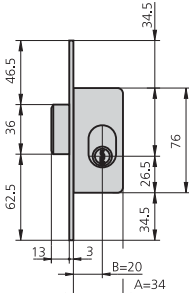
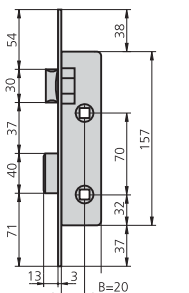
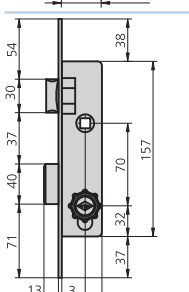
DESCRIPCIÓN	REF.	MEDIDAS		LEVA	ACABADOS		UDS		PRECIO	
		B	A		FRENTE	CILINDRO			COMPLETA	S/CILINDRO
 <ul style="list-style-type: none"> <li>• Picaporte y palanca</li> <li>• Cilindro ovalado 5964/2525</li> </ul> <p><b>Opciones de cerradero</b></p> <ul style="list-style-type: none"> <li>• CE1984/0 ó CE1984/6</li> </ul>	1964/0	20	34		HN	CN	1	20		
	1964/5	20	34		HN	CL	1	20		
	1964/6	20	34		Al	CN	1	20		
 <ul style="list-style-type: none"> <li>• Cerradura de sólo palanca</li> <li>• Cilindro ovalado 5964/2525</li> </ul> <p><b>Opciones de cerradero</b></p> <ul style="list-style-type: none"> <li>• CE2994S/6</li> </ul>	1964A/0	20	34		HN	CN	1	30		
	1964A/5	20	34		HN	CL	1	30		
 <ul style="list-style-type: none"> <li>• Cerradura de condena</li> <li>• Sin cilindro</li> </ul> <p><b>Opciones de cerradero</b></p> <ul style="list-style-type: none"> <li>• CE1984/0 ó CE1984/6</li> </ul>	1964C/0	20	34		HN		2	40		
	1964C/6	20	34		Al		2	40		
 <ul style="list-style-type: none"> <li>• Cerradura de pomo condena</li> <li>• Sin cilindro</li> </ul> <p><b>Opciones de cerradero</b></p> <ul style="list-style-type: none"> <li>• CE1984/6</li> </ul>	1964CP/6	20	34		Al		1	20		

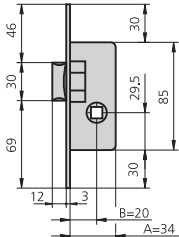
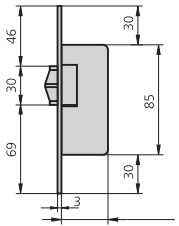
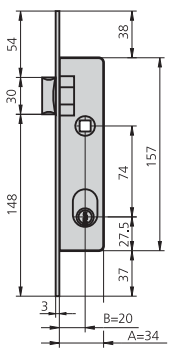
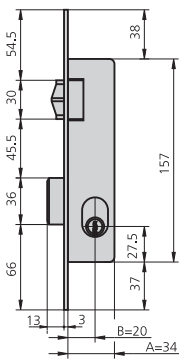
DESCRIPCIÓN	REF.	MEDIDAS		LEVA	ACABADOS		UDS		PRECIO	
		B	A		FRENTE	CILINDRO			COMPLETA	S/CILINDRO
 <ul style="list-style-type: none"> <li>Cerradura de sólo picaporte</li> <li>Sin cilindro</li> </ul> <p><b>Opciones de cerradero</b></p> <ul style="list-style-type: none"> <li>CE196R/6L</li> </ul>	1964R/0	20	34		HN		2	60		
 <ul style="list-style-type: none"> <li>Cerradura de sólo vaivén</li> <li>Sin cilindro</li> </ul> <p><b>Opciones de cerradero</b></p> <ul style="list-style-type: none"> <li>CE196R/6L</li> </ul>	1964RV/0		34		HN		2	60		
 <ul style="list-style-type: none"> <li>Cerradura de sólo picaporte</li> <li>Cilindro 5964T25</li> </ul> <p><b>Opciones de cerraderos eléctricos</b></p> <ul style="list-style-type: none"> <li>CEC41T/6A ó CEC41T/6AD</li> </ul>	1964T/0	20	34		HN	CN	1	20		
	1964T/5	20	34		HN	CL	1	20		
	1964T/6	20	34		AI	CN	1	20		
 <ul style="list-style-type: none"> <li>Rodillo vaivén regulable y palanca</li> <li>Cilindro 5964/2525</li> </ul> <p><b>Opciones de cerradero</b></p> <ul style="list-style-type: none"> <li>CE1984/0 ó CE1984/6</li> </ul>	1964V/0	20	34		HN	CN	1	20		
	1964V/5	20	34		HN	CL	1	20		
	1964V/6	20	34		AI	CN	1	20		

CERRADURA PARA PUERTAS DE ZÓCALO CON CILINDRO OVALADO DE VÁSTAGOS

SERIE 1981

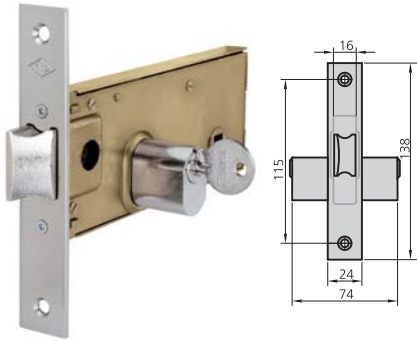

CARACTERÍSTICAS

- Frente de hierro niquelado
- Caja bicromatada
- Picaporte extensible y reversible
- Accionamiento extensible con llave
- Accionamiento del picaporte con llave y manilla
- Cuadradillo de 8mm
- Cilindro ovalado monoblock (5081) o cilindro redondo monoblock (5181)
- 2 escudos de nylon ref. ES1964 ó ES1962/4
- Tornillo de fijación de cilindro
- Cerradero CE1991/0

ACCESORIOS OPCIONALES

- Amplía gama de cilindros (ver página 127 - 148)

DESCRIPCIÓN	REF.	MEDIDAS		LEVA	ACABADOS		UDS		PRECIO	
		B	A		FRENTE	CILINDRO			COMPLETA	S/CILINDRO

CILINDRO OVALADO

- Cilindro ovalado 5081/3030
- Cerradero CE1991/0
- Escudo de nylon ES1964

1981/60/0	57	152		HN	CN	1	20		
1981/60/5	57	152		HN	CL	1	20		

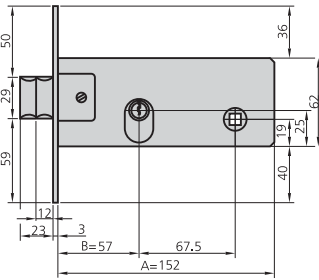

CILINDRO REDONDO

- Cilindro redondo 5181/3030
- Cerradero CE1991/0
- Escudo ES1962/4

11981/60/0	57	152		HN	CN	1	20		
11981/60/5	57	152		HN	CL	1	20		

CILINDRO OVALADO

- Vaivén extensible
- Cilindro ovalado 5081/3030
- Cerradero CE1991/0
- Escudo de nylon ES1964

1981V60/0	57	152		HN	CN	1	20		
1981V60/5	57	152		HN	CL	1	20		

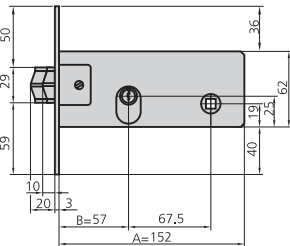

CILINDRO REDONDO

- Vaivén extensible
- Cilindro redondo 5181/3030
- Cerradero CE1991/0
- Escudo ES1962/4

11981V60/0	57	152		HN	CN	1	20		
11981V60/5	57	152		HN	CL	1	20		

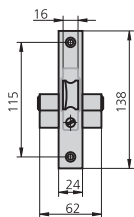

**CARACTERÍSTICAS**

- Frente de hierro niquelado
- Caja bicromatada
- Picaporte extensible y reversible
- Accionamiento extensible con llave
- Accionamiento del picaporte con llave y manilla
- Cuadradillo de 8mm
- Cilindro europerfil
- 2 escudos de nylon ref. ES1984
- Tornillo de fijación de cilindro
- Cerradero CE1991/0

**ACCESORIOS OPCIONALES**

- Amplia gama de cilindros (ver página 127 - 148)

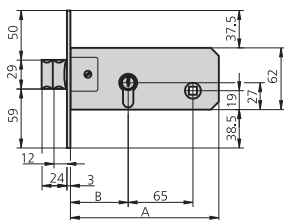
DESCRIPCIÓN	REF.	MEDIDAS		LEVA	ACABADOS		UDS		PRECIO	
		B	A		FRENTE	CILINDRO			COMPLETA	S/CILINDRO
• Picaporte extensible y reversible	1991/60/0	58	149	15	HN	CN	1	20		
• Cilindro europerfil 5982/2525	1991/60/5	58	149	15	HN	CL	1	20		
• Cerradero CE1991/0	1991/70/0	68	159	15	HN	CN	1	20		
	1991/70/5	68	159	15	HN	CL	1	20		



**CERRADURA DE SÓLO GANCHO CON CILINDRO OVALADO DE VÁSTAGOS**

**SERIE 1968**

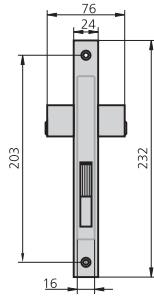

**CARACTERÍSTICAS**

- Frente de hierro niquelado
- Caja bicromatada
- Palanca de gancho
- Cilindro ovalado monoblock de vástagos
- 2 escudos de nylon ref. ES1964
- Tornillo de fijación de cilindro

**ACCESORIOS OPCIONALES**

DESCRIPCIÓN	REF.	MEDIDAS		LEVA	ACABADOS		UDS		PRECIO	
		B	A		FRENTE	CILINDRO			COMPLETA	S/CILINDRO
<ul style="list-style-type: none"> <li>• Cerradura con palanca basculante de gancho</li> <li>• Cilindro 5968/2525</li> </ul>	1968/0	17	34		HN	CN	1	20		
	1968/5	17	34		HN	CL	1	20		



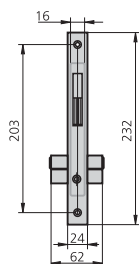

**CARACTERÍSTICAS**

- Frente de hierro niquelado
- Caja bicromatada
- Palanca de gancho
- Cilindro europerfil
- 2 escudos de nylon ref. E51984
- Tornillo de fijación de cilindro

**ACCESORIOS OPCIONALES**

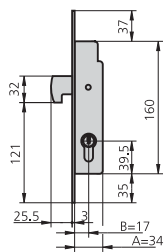
DESCRIPCIÓN	REF.	MEDIDAS		LEVA	ACABADOS		UDS		PRECIO	
		B	A		FRENTE	CILINDRO			COMPLETA	S/CILINDRO



- Cerradura con palanca basculante de gancho
- Cilindro 5982/2525

1982/0	17	34		HN	CN	1	20		
1982/5	17	34		HN	CL	1	20		

**CERRADURA DE SÓLO PICAPORTE PARA PUERTAS METÁLICAS**

**SERIE 1979**

**CARACTERÍSTICAS**

- Frente de hierro niquelado
- Caja bicromatada
- Picaporte reversible accionado con llave por el exterior y con pomo por el interior o accionamiento con llave por ambos lados
- Cilindro ovalado monoblock de vástagos
- 2 escudos de nylon ref. ES1964
- Tornillo de fijación de cilindro

**ACCESORIOS OPCIONALES**

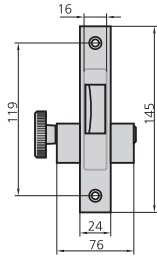

**DESCRIPCIÓN**

REF.	MEDIDAS		LEVA	ACABADOS		UDS		PRECIO	
	B	A		FRENTE	CILINDRO			COMPLETA	S/CILINDRO

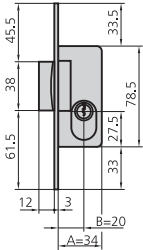

- Picaporte reversible accionado con llave por el exterior y pomo por el interior
- 5979P3030

1979P/0	20	34		HN	CN	1	30		
1979P/5	20	34		HN	CL	1	30		

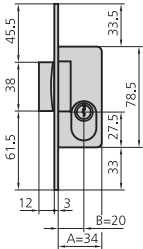

- Picaporte reversible accionado con llave por el exterior y por el interior
- 5979/3030

1979/0	20	34		HN	CN	1	30		
1979/5	20	34		HN	CL	1	30		

**CARACTERÍSTICAS**

- Cerradura para puertas metálicas enrollables
- Accionamiento exterior e interior mediante llave
- Caja bicromatada
- Cilindro redondo de 3 pitones

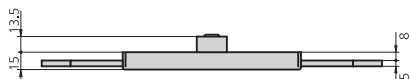
**ACCESORIOS OPCIONALES**

**DESCRIPCIÓN**
**REF.**
**MEDIDAS**  
**B A**
**LEVA**
**ACABADOS**  
**FRENTE CILINDRO**
**UDS**

**PRECIO**
**COMPLETA S/CILINDRO**

- Dos puntos de cierre laterales

11A

60 154

CL

1

24

[ ] [ ]

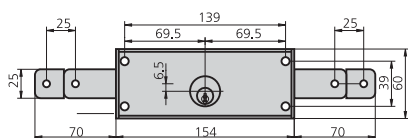

- Dos puntos de cierre laterales y un punto inferior

11A/3P

60 154

CL

1

[ ] [ ]

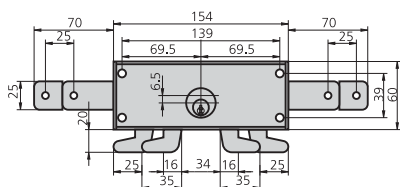

**CERRADURA PARA PUERTAS Y PERSIANAS METÁLICAS ENROLLABLES**

**SERIE 11E**

**CARACTERÍSTICAS**

- Cerradura para persiana metálica enrollable
- Accionamiento exterior e interior mediante llave
- Cilindro redondo de 3 pitones

**ACCESORIOS OPCIONALES**

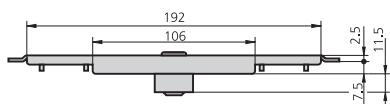

**DESCRIPCIÓN**

**REF.**

**MEDIDAS**  
B A

**LEVA**

**ACABADOS**  
FRENTE CILINDRO

**UDS**  
 

**PRECIO**  
COMPLETA S/CILINDRO

- Dos puntos de cierre horizontales

11E	30	216		CL	1	20		
-----	----	-----	--	----	---	----	--	--

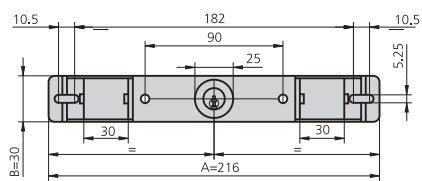

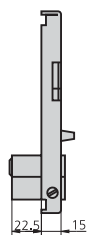

**CARACTERÍSTICAS**

- Accionamiento mediante manilla.
- Bloqueo interior mediante botón, bloqueo exterior mediante llave
- 2 puntos de cierre horizontales
- Caja bicromatada
- Medio cilindro monoblock ref. 5982T40/3
- Opcionalmente con set de escudo y manillas (ref. 11B/M)
- 1 Escudo ref. ES1960

**ACCESORIOS OPCIONALES**

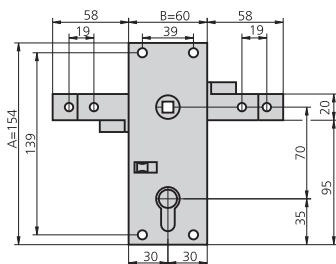

DESCRIPCIÓN	REF.	MEDIDAS		LEVA	ACABADOS		UDS		PRECIO	
		B	A		FRENTE	CILINDRO			COMPLETA	S/CILINDRO
• Dos puntos de cierre horizontales	11B	60	154	15	CL		1	40		
• Medio cilindro monoblock 5982T40/3	11B/M	60	154	15	CL		1	40		



**ACCESORIOS**

**CERRADEROS PARA CERRADURAS METÁLICAS**

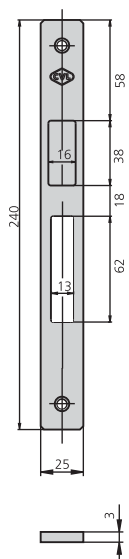
DESCRIPCIÓN	REF.	ACABADO	APLICABLE A CERRADURAS	UDS  	PRECIO COMPLETA	S/CILINDRO
-------------	------	---------	------------------------	-----------------------------------------------------------------------------------------------------------------------------------------------------------------------------	-----------------	------------



CE1983/0	HN	1983				
CE1983/6	Al					

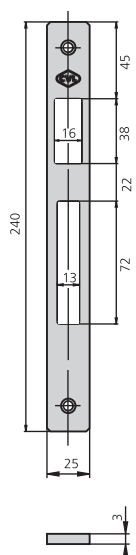

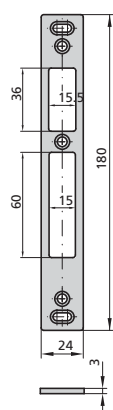

CE1984

CE1984/0	HN	1984, 1992, 1995,				
CE1984/6	Al	1964, 1963, 1975				



CE190/0	HN	190				
CE190/6	Al	190				

DESCRIPCIÓN	REF.	ACABADO	APLICABLE A CERRADURAS	UDS  	PRECIO COMPLETA	S/CILINDRO
-------------	------	---------	------------------------	-----------------------------------------------------------------------------------------------------------------------------------------------------------------------------	-----------------	------------

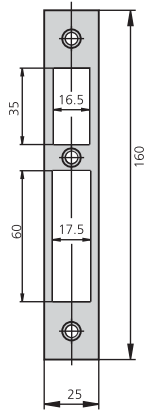

CE1990/0      HN      1990

--	--

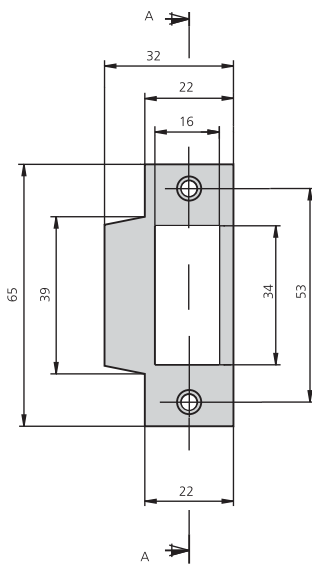
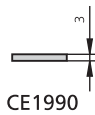

CE1991/0      HN      1991, 1981, 11981

--	--

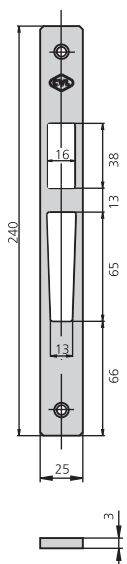



CE1994/6      Al      1994, 2994

--	--

ACCESORIOS

CERRADEROS PARA CERRADURAS METÁLICAS

DESCRIPCIÓN	REF.	ACABADO	APLICABLE A CERRADURAS	UDS  	PRECIO COMPLETA S/CILINDRO
-------------	------	---------	------------------------	-----------------------------------------------------------------------------------------------------------------------------------------------------------------------------	----------------------------

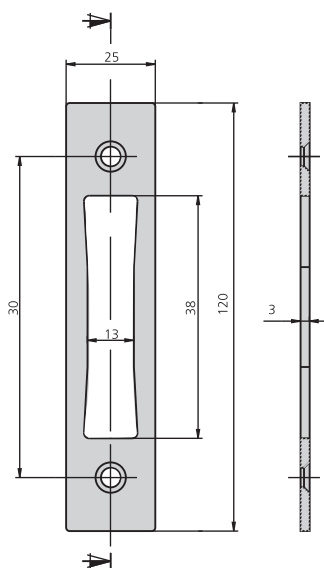

CE2994S/6 Al 1983A, 1963A, 1975A, 1995A, alto/bajo 2994

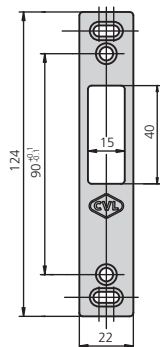

--	--



CE196R/6 Al 1963R, 1964R, 1983R, 1995R



--	--

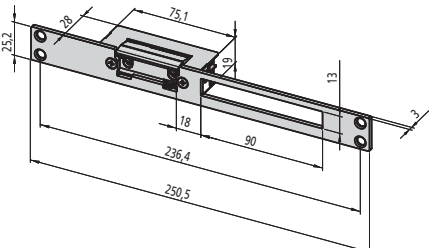
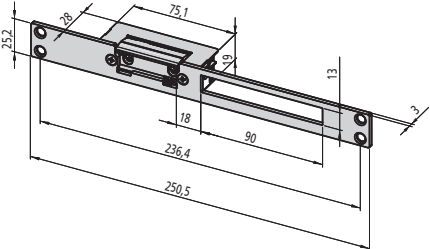
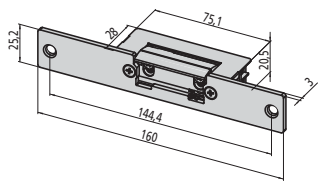
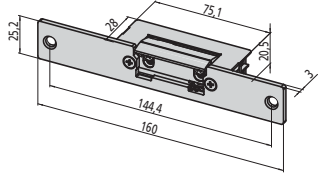

DESCRIPCIÓN	REF.	APLICABLE A CERRADURAS	UDS 	PRECIO COMPLETA S/CILINDRO 
<ul style="list-style-type: none"> <li>• Cerradero eléctrico regulable reversible con funcionamiento automático</li> <li>• Frente plano inox</li> </ul> 	CELC45/6A	-----	-----	-----
<ul style="list-style-type: none"> <li>• Cerradero eléctrico regulable reversible con funcionamiento automático y con desbloqueo</li> <li>• Frente plano inox</li> </ul> 	CELC45/6AD	-----	-----	-----
<ul style="list-style-type: none"> <li>• Cerradero eléctrico regulable reversible con funcionamiento automático</li> <li>• Sólo picaporte y frente plano inox</li> </ul> 	CELC45T/6A	-----	-----	-----
<ul style="list-style-type: none"> <li>• Cerradero eléctrico regulable reversible con funcionamiento automático y con desbloqueo</li> <li>• Sólo picaporte y frente plano inox</li> </ul> 	CELC45T/6AD	-----	-----	-----





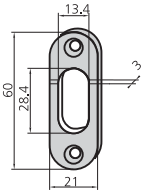
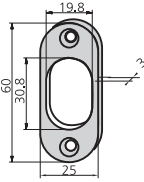
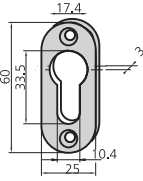

**ACCESORIOS**

**ESCUDOS**

DESCRIPCIÓN	REF.	ACABADO	APLICABLE A CERRADURAS	UDS		PRECIO	
						COMPLETA	S/CILINDRO
	ES1963	Escudo de nylon	1963, 1975				
	ES1964	Escudo de nylon	1964, 1968, 1979, 1981				
	ES1984	Escudo de nylon	1982, 1983, 1984, 1990, 1992, 1994, 1995, 196, 184, 183, 192, 194, 194, P194				

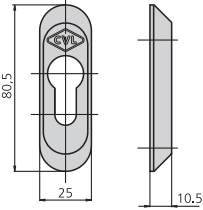
**ACCESORIOS**

**ESCUDOS DE SEGURIDAD**

DESCRIPCIÓN	REF.	ACABADO	APLICABLE A CERRADURAS	UDS		PRECIO	
						COMPLETA	S/CILINDRO
	BT194/1N BT194/1NM BT194/1PL	Negro Niquel mate Plata	1983, 1984, 1990, 1992, 1994, 1995, 2994, 183, 184, 192				
	NEGRO						
	NIQUEL MATE						
	PLATA						

## CERRADURAS DE SOBREPONER

	Cerradura de sobreponer Serie 56	86
	• Serie 56A	86
	• Serie 56B	87
	• Serie 56C	88
	Cerradura de sobreponer Serie 125	89
	• Serie 125A	89
	• Serie 125B	90
	Cerradura de sobreponer Serie 124	91
	• Serie 124A	91
	Cerradura de sobreponer Serie 122	92
	• Serie 122A	92
	• Serie 122C	93
	Cerradura de sobreponer Serie 123	94
	• Serie 123A	94
	• Serie 123C	95
Cerrojos	96	
• Serie 1976	96	
• Serie 1978	97	
• Serie 1988	98	
Picaportes	99	
• Serie 234	99	
• Serie 236	100	
Cerraderos eléctricos	101	

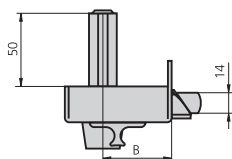

**CARACTERÍSTICAS**

- Picaporte accionado por llave exteriormente y con llave y tirador desde el interior
- Palanca de una vuelta de llave accionable por ambos lados
- Posibilidad de elección entre cilindro de perfil o cilindro redondo
- Dos acabados: hierro esmaltado y hierro niquelado
- Cerradero según cerradura
- Embellecedor según tipo de cilindro
- componentes de sujeción

**ACCESORIOS OPCIONALES**

- Cerraderos eléctricos (ver página 101)
- Cilindro de seguridad

**DESCRIPCIÓN**

**REF.**

**MEDIDAS**  
B A

**CILINDRO**

**ACABADOS**  
FRENTE CILINDRO

**UDS**

**PRECIO**  
COMPLETA S/CILINDRO

- Cilindro perfil ref. 5056/50/3
- Cerradero ref. CE56AD ó CE56AI
- Embellecedor ES125
- Opcional**
- Cerradero CELC56/1A ó CELC56/1BA

56A60D/0	35	60	5056/50/3	HN	CL	1	24		
56A60I/0	35	60	5056/50/3	HN	CL	1	24		
56A60D/1	35	60	5056/50/3	HE	CL	1	24		
56A60I/1	35	60	5056/50/3	HE	CL	1	24		
56A70D/0	45	70	5056/50/3	HN	CL	1	24		
56A70I/0	45	70	5056/50/3	HN	CL	1	24		
56A70D/1	45	70	5056/50/3	HE	CL	1	24		
56A70I/1	45	70	5056/50/3	HE	CL	1	24		

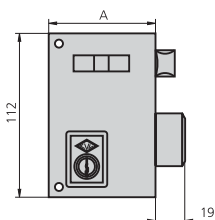

- Cilindro redondo ref. 5156/50/3
- Cerradero ref. CE56AD ó CE56AI
- Embellecedor ES1125
- Opciones cerraderos eléctricos**
- CELC56/1A ó CELC56/1BA

156A60D/0	35	60	5156/50/3	HN	CL	1	24		
156A60I/0	35	60	5156/50/3	HN	CL	1	24		
156A60D/1	35	60	5156/50/3	HE	CL	1	24		
156A60I/1	35	60	5156/50/3	HE	CL	1	24		
156A70D/0	45	70	5156/50/3	HN	CL	1	24		
156A70I/0	45	70	5156/50/3	HN	CL	1	24		
156A70D/1	45	70	5156/50/3	HE	CL	1	24		
156A70I/1	45	70	5156/50/3	HE	CL	1	24		

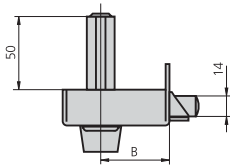
**CARACTERÍSTICAS**

- Picaporte accionado mediante manilla por ambos lados
- Palanca de una vuelta de llave accionable por ambos lados
- Posibilidad de elección entre cilindro de perfil o cilindro redondo
- Dos acabados: hierro esmaltado y hierro niquelado
- Cerradero según cerradura
- Embellecedor según tipo de cilindro
- Componentes de sujeción

**ACCESORIOS OPCIONALES**

- Cerraderos eléctricos (ver página 101)
- Cilindro de seguridad

DESCRIPCIÓN	REF.	MEDIDAS		CILINDRO	ACABADOS		UDS		PRECIO	
		B	A		FRENTE	CILINDRO			COMPLETA	S/CILINDRO
• Cilindro perfil ref. 5056/50/3	56B60D/0	35	60	5056/50/3	HN	CL	1	24		
• Cerradero ref. CE56AD ó CE56AI	56B60I/0	35	60	5056/50/3	HN	CL	1	24		
• Picaporte reversible en la medida de 70mm (ref. 56BR)	56B60D/1	35	60	5056/50/3	HE	CL	1	24		
• Embellecedor ES125	56B60I/1	35	60	5056/50/3	HE	CL	1	24		
	56BR70D/0	45	70	5056/50/3	HN	CL	1	24		
	56BR70I/0	45	70	5056/50/3	HN	CL	1	24		
	56BR70D/1	45	70	5056/50/3	HE	CL	1	24		
	56BR70I/1	45	70	5056/50/3	HE	CL	1	24		

**Opciones cerraderos eléctricos**

- CELC56/1A ó CELC56/1BA

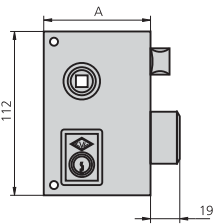

• Cilindro redondo ref. 5156/50/3	156B60D/0	35	60	5156/50/3	HN	CL	1	24		
• Cerradero ref. CE56AD ó CE56AI	156B60I/0	35	60	5156/50/3	HN	CL	1	24		
• Picaporte reversible en la medida de 70mm (ref. 156BR)	156B60D/1	35	60	5156/50/3	HE	CL	1	24		
• Embellecedor ES1125	156B60I/1	35	60	5156/50/3	HE	CL	1	24		
	156BR70D/0	45	70	5156/50/3	HN	CL	1	24		
	156BR70I/0	45	70	5156/50/3	HN	CL	1	24		
	156BR70D/1	45	70	5156/50/3	HE	CL	1	24		
	156BR70I/1	45	70	5156/50/3	HE	CL	1	24		

**Opciones cerraderos eléctricos**

- CELC56/1A ó CELC56/1BA



**CARACTERÍSTICAS**

- Palanca de una vuelta de llave accionable por ambos lados
- Posibilidad de elección entre cilindro de perfil o cilindro redondo
- Dos acabados: hierro esmaltado y hierro niquelado
- Cerradero según cerradura
- Embellecedor según tipo de cilindro
- componentes de sujeción

**ACCESORIOS OPCIONALES**

- Cilindro de seguridad

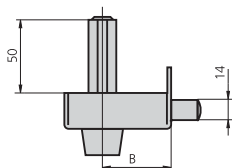

**DESCRIPCIÓN**

**REF.**

**MEDIDAS CILINDRO**  
B A

**ACABADOS**  
FRENTE CILINDRO

**UDS**  
 

**PRECIO**  
COMPLETA S/CILINDRO

- Cilindro perfil ref. 5056/50/3
- Cerradero ref. CE56C/1 ó CE56C/0
- Embellecedor ES125

56C60D/0	35	60	5056/50/3	HN	CL	1	24		
56C60I/0	35	60	5056/50/3	HN	CL	1	24		
56C60D/1	35	60	5056/50/3	HE	CL	1	24		
56C60I/1	35	60	5056/50/3	HE	CL	1	24		
56C70D/0	45	70	5056/50/3	HN	CL	1	24		
56C70I/0	45	70	5056/50/3	HN	CL	1	24		
56C70D/1	45	70	5056/50/3	HE	CL	1	24		
56C70I/1	45	70	5056/50/3	HE	CL	1	24		

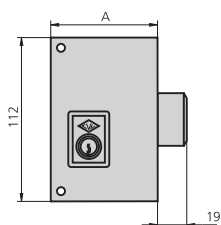

- Cilindro redondo ref. 5156/50/3
- Cerradero ref. CE56C/1 ó CE56C/0
- Embellecedor ES1125

156C60D/0	35	60	5156/50/3	HN	CL	1	24		
156C60I/0	35	60	5156/50/3	HN	CL	1	24		
156C60D/1	35	60	5156/50/3	HE	CL	1	24		
156C60I/1	35	60	5156/50/3	HE	CL	1	24		
156C70D/0	45	70	5156/50/3	HN	CL	1	24		
156C70I/0	45	70	5156/50/3	HN	CL	1	24		
156C70D/1	45	70	5156/50/3	HE	CL	1	24		
156C70I/1	45	70	5156/50/3	HE	CL	1	24		

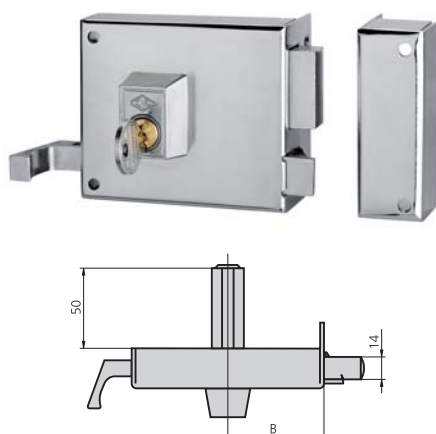

**CARACTERÍSTICAS**

- Picaporte accionado por llave exteriormente y con llave y tirador desde el interior
- Palanca de dos vueltas de llave accionable por ambos lados
- Posibilidad de elección entre cilindro de perfil o cilindro redondo
- Dos acabados: hierro esmaltado y hierro niquelado
- Cerradero según cerradura
- Embellecedor según tipo de cilindro
- Componentes de sujeción

**ACCESORIOS OPCIONALES**

- Cerraderos eléctricos (ver página 101)
- Cilindro de seguridad

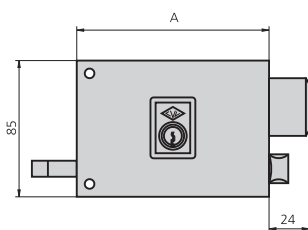
DESCRIPCIÓN	REF.	MEDIDAS		CILINDRO	ACABADOS		UDS		PRECIO	
		B	A		FRENTE	CILINDRO			COMPLETA	S/CILINDRO
<ul style="list-style-type: none"> <li>• Cilindro perfil ref. 5056/50/3</li> <li>• Picaporte reversible en la medida de 100mm (REF. 125AR)</li> <li>• Cerradero ref. CE125AD ó CE125AI</li> <li>• Embellecedor ES125</li> </ul>	125A8D/0	47	90	5056/50/3	HN	CL	1	20		
	125A8I/0	47	90	5056/50/3	HN	CL	1	20		
	125A8D/1	47	90	5056/50/3	HE	CL	1	20		
	125A8I/1	47	90	5056/50/3	HE	CL	1	20		
	125AR10D/0	60	100	5056/50/3	HN	CL	1	20		
	125AR10I/0	60	100	5056/50/3	HN	CL	1	20		
	125AR10D/1	60	100	5056/50/3	HE	CL	1	20		
	125AR10I/1	60	100	5056/50/3	HE	CL	1	20		
	125A12D/0	60	120	5056/50/3	HN	CL	1	20		
	125A12I/0	60	120	5056/50/3	HN	CL	1	20		
	125A12D/1	60	120	5056/50/3	HE	CL	1	20		
	125A12I/1	60	120	5056/50/3	HE	CL	1	20		
	125A14D/0	70	140	5056/50/3	HN	CL	1	20		
	125A14I/0	70	140	5056/50/3	HN	CL	1	20		
	125A14D/1	70	140	5056/50/3	HE	CL	1	20		
	125A14I/1	70	140	5056/50/3	HE	CL	1	20		
	1125A8D/0	47	90	5156/50/3	HN	CL	1	20		
	1125A8I/0	47	90	5156/50/3	HN	CL	1	20		
	1125A8D/1	47	90	5156/50/3	HE	CL	1	20		
	1125A8I/1	47	90	5156/50/3	HE	CL	1	20		
	1125AR10D/0	60	100	5156/50/3	HN	CL	1	20		
	1125AR10I/0	60	100	5156/50/3	HN	CL	1	20		
	1125AR10D/1	60	100	5156/50/3	HE	CL	1	20		
	1125AR10I/1	60	100	5156/50/3	HE	CL	1	20		
	1125A12D/0	60	120	5156/50/3	HN	CL	1	20		
	1125A12I/0	60	120	5156/50/3	HN	CL	1	20		
	1125A12D/1	60	120	5156/50/3	HE	CL	1	20		
	1125A12I/1	60	120	5156/50/3	HE	CL	1	20		
	1125A14D/0	70	140	5156/50/3	HN	CL	1	20		
	1125A14I/0	70	140	5156/50/3	HN	CL	1	20		
	1125A14D/1	70	140	5156/50/3	HE	CL	1	20		
	1125A14I/1	70	140	5156/50/3	HE	CL	1	20		



- Cilindro redondo ref. 5156/50/3
- Picaporte reversible en la medida de 100mm (REF. 1125AR)
- Cerradero ref. CE125AD ó CE125AI
- Embellecedor ES1125

**Opciones cerraderos eléctricos**

- CELC125/1A ó CELC125/1BA

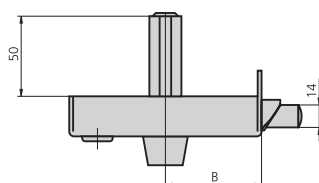

**CARACTERÍSTICAS**

- Picaporte accionado por manilla por ambos lados
- Picaporte reversible
- Palanca de dos vueltas de llave accionable por ambos lados
- Posibilidad de elección entre cilindro de perfil o cilindro redondo
- Dos acabados: hierro esmaltado y hierro niquelado
- Cerradero según cerradura
- Embellecedor según tipo de cilindro
- Componentes de sujeción

**ACCESORIOS OPCIONALES**

- Cerraderos eléctricos (ver página 101)
- Cilindro de seguridad

**DESCRIPCIÓN**

REF.	MEDIDAS		CILINDRO	ACABADOS		UDS		PRECIO	
	B	A		FRENTE	CILINDRO			COMPLETA	S/CILINDRO

- Cilindro perfil ref. 5056/50/3
- Picaporte reversible
- Cerradero ref. CE125AD ó CE125AI
- Embellecedor ES125

**Opciones cerraderos eléctricos**

- CELC125/1A ó CELC125/1BA

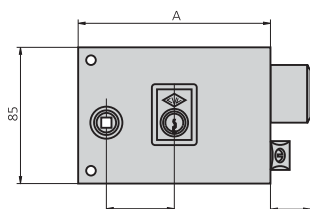

- Cilindro redondo ref. 5156/50/3
- Picaporte reversible
- Cerradero ref. CE125AD ó CE125AI
- Embellecedor ES1125

**Opciones cerraderos eléctricos**

- CELC125/1A ó CELC125/1BA

125BR12D/0	60	120	5056/50/3	HN	CL	1	24		
125BR12I/0	60	120	5056/50/3	HN	CL	1	24		
125BR12D/1	60	120	5056/50/3	HE	CL	1	24		
125BR12I/1	60	120	5056/50/3	HE	CL	1	24		
125BR14D/0	70	140	5056/50/3	HN	CL	1	24		
125BR14I/0	70	140	5056/50/3	HN	CL	1	24		
125BR14D/1	70	140	5056/50/3	HE	CL	1	24		
125BR14I/1	70	140	5056/50/3	HE	CL	1	24		

1125BR12D/0	60	120	5156/50/3	HN	CL	1	24		
1125BR12I/0	60	120	5156/50/3	HN	CL	1	24		
1125BR12D/1	60	120	5156/50/3	HE	CL	1	24		
1125BR12I/1	60	120	5156/50/3	HE	CL	1	24		
1125BR14D/0	70	140	5156/50/3	HN	CL	1	24		
1125BR14I/0	70	140	5156/50/3	HN	CL	1	24		
1125BR14D/1	70	140	5156/50/3	HE	CL	1	24		
1125BR14I/1	70	140	5156/50/3	HE	CL	1	24		





**CARACTERÍSTICAS**

- Palanca de dos vueltas de llave accionable por ambos lados
- Posibilidad de elección entre cilindro de perfil o cilindro redondo
- Dos acabados: hierro esmaltado y hierro niquelado
- Cerradero según cerradura
- Embellecedor según tipo de cilindro
- Componentes de sujeción

**ACCESORIOS OPCIONALES**

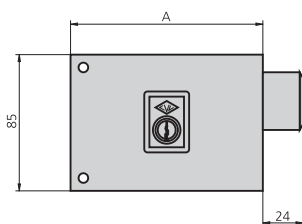
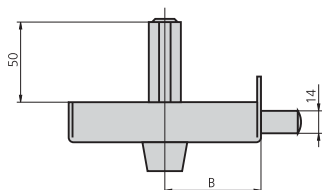
- Cilindro de seguridad



- Cilindro perfil ref. 5056/50/3
- Cerradero ref. CE125AD ó CE125AI
- Embellecedor ES125

- Cilindro redondo ref. 5156/50/3
- Cerradero ref. CE125AD ó CE125AI
- Embellecedor ES1125

DESCRIPCIÓN	REF.	MEDIDAS		CILINDRO	ACABADOS		UDS		PRECIO	
		B	A		FRENTE	CILINDRO			COMPLETA	S/CILINDRO
	124A8D/0	47	90	5056/50/3	HN	CL	1	24		
	124A8I/0	47	90	5056/50/3	HN	CL	1	24		
	124A8D/1	47	90	5056/50/3	HE	CL	1	24		
	124A8I/1	47	90	5056/50/3	HE	CL	1	24		
	124A10D/0	60	100	5056/50/3	HN	CL	1	24		
	124A10I/0	60	100	5056/50/3	HN	CL	1	24		
	124A10D/1	60	100	5056/50/3	HE	CL	1	24		
	124A10I/1	60	100	5056/50/3	HE	CL	1	24		
	124A12D/0	60	120	5056/50/3	HN	CL	1	24		
	124A12I/0	60	120	5056/50/3	HN	CL	1	24		
	124A12D/1	60	120	5056/50/3	HE	CL	1	24		
	124A12I/1	60	120	5056/50/3	HE	CL	1	24		
	124A14D/0	70	140	5056/50/3	HN	CL	1	24		
	124A14I/0	70	140	5056/50/3	HN	CL	1	24		
	124A14D/1	70	140	5056/50/3	HE	CL	1	24		
	124A14I/1	70	140	5056/50/3	HE	CL	1	24		
	1124A8D/0	47	90	5156/50/3	HN	CL	1	24		
	1124A8I/0	47	90	5156/50/3	HN	CL	1	24		
	1124A8D/1	47	90	5156/50/3	HE	CL	1	24		
	1124A8I/1	47	90	5156/50/3	HE	CL	1	24		
	1124A10D/0	60	100	5156/50/3	HN	CL	1	24		
	1124A10I/0	60	100	5156/50/3	HN	CL	1	24		
	1124A10D/1	60	100	5156/50/3	HE	CL	1	24		
	1124A10I/1	60	100	5156/50/3	HE	CL	1	24		
	1124A12D/0	60	120	5156/50/3	HN	CL	1	24		
	1124A12I/0	60	120	5156/50/3	HN	CL	1	24		
	1124A12D/1	60	120	5156/50/3	HE	CL	1	24		
	1124A12I/1	60	120	5156/50/3	HE	CL	1	24		
	1124A14D/0	70	140	5156/50/3	HN	CL	1	24		
	1124A14I/0	70	140	5156/50/3	HN	CL	1	24		
	1124A14D/1	70	140	5156/50/3	HE	CL	1	24		
	1124A14I/1	70	140	5156/50/3	HE	CL	1	24		

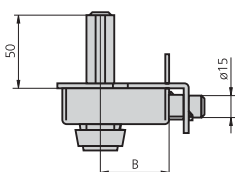

**CARACTERÍSTICAS**

- Cerradura de sobreponer reforzada
- Picaporte accionado por llave exteriormente y con llave o pomo desde el interior
- Palanca de 3 bulones de acero a dos vueltas de llave accionable por ambos lados del cilindro
- Sistema antipalanqueta
- Posibilidad de elección entre cilindro de perfil o cilindro redondo
- Dos acabados: hierro esmaltado y hierro niquelado
- Cerradero según cerradura
- Embellecedor según tipo de cilindro
- Componentes de sujeción

**ACCESORIOS OPCIONALES**

- Cilindro de seguridad

**DESCRIPCIÓN**

REF.	MEDIDAS CILINDRO		ACABADOS		UDS		PRECIO	
	B	A	FRENTE	CILINDRO			COMPLETA	S/CILINDRO

- Cilindro perfil ref. 5056/50/3
- Cerradero ref. CE122AD ó CE122AI
- Embellecedor ES125

122A70D/0	45	70	5056/50/3	HN	CL	1	10		
122A70I/0	45	70	5056/50/3	HN	CL	1	10		
122A70D/1	45	70	5056/50/3	HE	CL	1	10		
122A70I/1	45	70	5056/50/3	HE	CL	1	10		

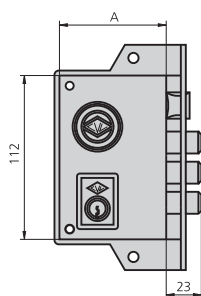

- Cilindro redondo ref. 5156/50/3
- Cerradero ref. CE122AD ó CE122AI
- Embellecedor ES1125

1122A70D/0	45	70	5156/50/3	HN	CL	1	10		
1122A70I/0	45	70	5156/50/3	HN	CL	1	10		
1122A70D/1	45	70	5156/50/3	HE	CL	1	10		
1122A70I/1	45	70	5156/50/3	HE	CL	1	10		

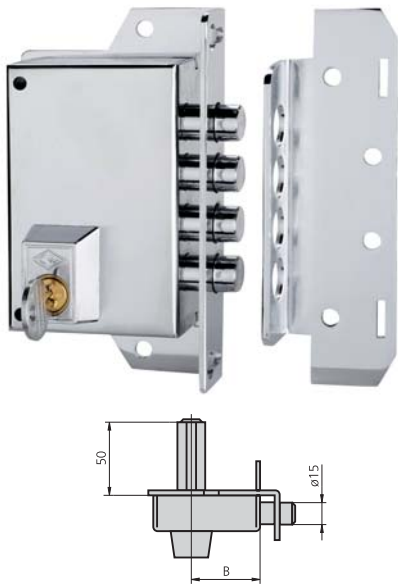

**CARACTERÍSTICAS**

- Cerradura de sobreponer reforzada
- Palanca de 4 bulones de acero a dos vueltas de llave accionable por ambos lados del cilindro
- Sistema antipalanqueta
- Posibilidad de elección entre cilindro de perfil o cilindro redondo
- Dos acabados: hierro esmaltado y hierro niquelado
- Cerradero según cerradura
- Embellecedor según tipo de cilindro
- Componentes de sujeción

**ACCESORIOS OPCIONALES**

- Cilindro de seguridad

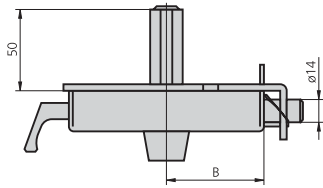
DESCRIPCIÓN	REF.	MEDIDAS CILINDRO		ACABADOS		UDS		PRECIO		
		B	A	FRENTE	CILINDRO			COMPLETA	S/CILINDRO	
<ul style="list-style-type: none"> <li>• Cilindro perfil ref. 5056/50/3</li> <li>• Cerradero ref. CE122C/1 ó CE122C/0</li> <li>• Embellecedor ES125</li> </ul>	122C70D/0	45	70	5056/50/3	HN	CL	1	10		
	122C70I/0	45	70	5056/50/3	HN	CL	1	10		
	122C70D/1	45	70	5056/50/3	HE	CL	1	10		
	122C70I/1	45	70	5056/50/3	HE	CL	1	10		
<ul style="list-style-type: none"> <li>• Cilindro redondo ref. 5156/50/3</li> <li>• Cerradero ref. CE122C/1 ó CE122C/0</li> <li>• Embellecedor ES1125</li> </ul>	1122C70D/0	45	70	5156/50/3	HN	CL	1	10		
	1122C70I/0	45	70	5156/50/3	HN	CL	1	10		
	1122C70D/1	45	70	5156/50/3	HE	CL	1	10		
	1122C70I/1	45	70	5156/50/3	HE	CL	1	10		



**CARACTERÍSTICAS**

- Cerradura de sobreponer reforzada
- Picaporte accionable mediante llave por el exterior y con tirador o llave desde el interior
- Palanca de 3 bulones de acero a dos vueltas de llave accionable por ambos lados del cilindro
- Sistema antipalanqueta
- Posibilidad de elección entre cilindro de perfil o cilindro redondo
- Dos acabados: hierro esmaltado y hierro niquelado
- Cerradero según cerradura
- Embellecedor según tipo de cilindro
- Componentes de sujeción

**ACCESORIOS OPCIONALES**

- Cilindro de seguridad

DESCRIPCIÓN	REF.	MEDIDAS CILINDRO		ACABADOS		UDS		PRECIO		
		B	A	FRENTE	CILINDRO			COMPLETA	S/CILINDRO	
<ul style="list-style-type: none"> <li>• Cilindro perfil ref. 5056/50/3</li> <li>• Cerradero ref. CE123AD ó CE123AI</li> <li>• Embellecedor ES125</li> </ul>	123A10D/0	60	100	5056/50/3	HN	CL	1	10		
	123A10I/0	60	100	5056/50/3	HN	CL	1	10		
	123A10D/1	60	100	5056/50/3	HE	CL	1	10		
	123A10I/1	60	100	5056/50/3	HE	CL	1	10		
	123A12D/0	60	120	5056/50/3	HN	CL	1	10		
	123A12I/0	60	120	5056/50/3	HN	CL	1	10		
	123A12D/1	60	120	5056/50/3	HE	CL	1	10		
	123A12I/1	60	120	5056/50/3	HE	CL	1	10		

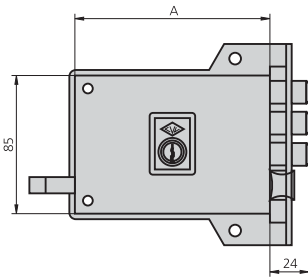

- Cilindro redondo ref. 5156/50/3
- Cerradero ref. CE123AD ó CE123AI
- Embellecedor ES1125

1123A10D/0	60	100	5156/50/3	HN	CL	1	10		
1123A10I/0	60	100	5156/50/3	HN	CL	1	10		
1123A10D/1	60	100	5156/50/3	HE	CL	1	10		
1123A10I/1	60	100	5156/50/3	HE	CL	1	10		
1123A12D/0	60	120	5156/50/3	HN	CL	1	10		
1123A12I/0	60	120	5156/50/3	HN	CL	1	10		
1123A12D/1	60	120	5156/50/3	HE	CL	1	10		
1123A12I/1	60	120	5156/50/3	HE	CL	1	10		

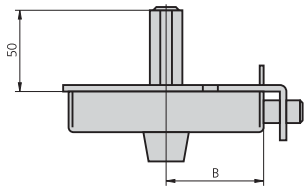

**CARACTERÍSTICAS**

- Cerradura de sobreponer reforzada
- Palanca de 4 bulones de acero a dos vueltas de llave accionable por ambos lados del cilindro
- Sistema antipalanqueta
- Posibilidad de elección entre cilindro de perfil o cilindro redondo
- Dos acabados: hierro esmaltado y hierro niquelado
- Cerradero según cerradura
- Embellecedor según tipo de cilindro
- Componentes de sujeción

**ACCESORIOS OPCIONALES**

- Cilindro de seguridad

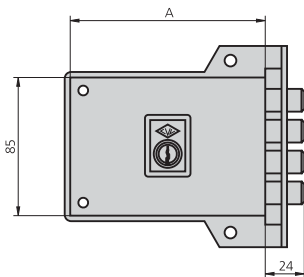
DESCRIPCIÓN	REF.	MEDIDAS		CILINDRO	ACABADOS		UDS		PRECIO	
		B	A		FRENTE	CILINDRO			COMPLETA	S/CILINDRO
<ul style="list-style-type: none"> <li>• Cilindro perfil ref. 5056/50/3</li> <li>• Cerradero ref. CE123C/1 ó CE123C/1</li> <li>• Embellecedor ES125</li> </ul>	123C10D/0	60	100	5056/50/3	HN	CL	1	10		
	123C10I/0	60	100	5056/50/3	HN	CL	1	10		
	123C10D/1	60	100	5056/50/3	HE	CL	1	10		
	123C10I/1	60	100	5056/50/3	HE	CL	1	10		
	123C12D/0	60	120	5056/50/3	HN	CL	1	10		
	123C12I/0	60	120	5056/50/3	HN	CL	1	10		
	123C12D/1	60	120	5056/50/3	HE	CL	1	10		
	123C12I/1	60	120	5056/50/3	HE	CL	1	10		



- Cilindro redondo ref. 5156/50/3
- Cerradero ref. CE123C/1 ó CE123C/1
- Embellecedor ES1125

1123C10D/0	60	100	5156/50/3	HN	CL	1	10		
1123C10I/0	60	100	5156/50/3	HN	CL	1	10		
1123C10D/1	60	100	5156/50/3	HE	CL	1	10		
1123C10I/1	60	100	5156/50/3	HE	CL	1	10		
1123C12D/0	60	120	5156/50/3	HN	CL	1	10		
1123C12I/0	60	120	5156/50/3	HN	CL	1	10		
1123C12D/1	60	120	5156/50/3	HE	CL	1	10		
1123C12I/1	60	120	5156/50/3	HE	CL	1	10		

CARACTERÍSTICAS

- Cerrojo de seguridad reversible aplicable a puertas metálicas basculantes o enrollables
- Se suministra por parejas con la misma llave
- Palanca deslizante de acero accionable por llave desde el exterior
- Cilindro exterior redondo diámetro 26mm
- Acabado en hierro esmaltado

ACCESORIOS OPCIONALES

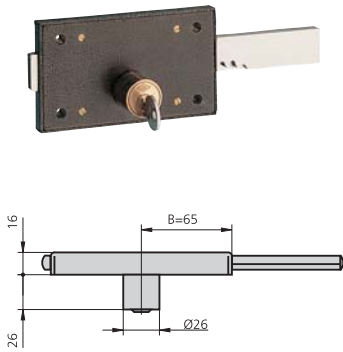

DESCRIPCIÓN

REF.	MEDIDAS		CILINDRO	ACABADOS		UDS		PRECIO	
	B	A		FRENTE	CILINDRO			COMPLETA	S/CILINDRO

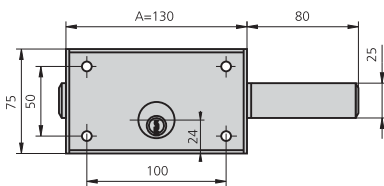

1976/1	65	130	Ø 26mm	HE	CL	1	17		
--------	----	-----	--------	----	----	---	----	--	--

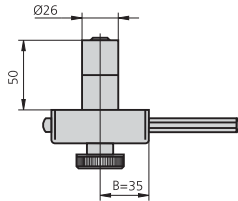

**CARACTERÍSTICAS**

- Cerrojo de seguridad reversible
- Palanca deslizante de acero accionable por llave desde el exterior y mediante pomo desde el interior
- Cilindro exterior redondo diámetro 26mm
- Dos acabados: hierro esmaltado y hierro niquelado
- Cerradero CE1978/1 ó CE1978/0
- Embellecedor ES1125
- Componentes de sujeción

**ACCESORIOS OPCIONALES**

- Cilindro de seguridad
- Cilindros de distintas longitudes

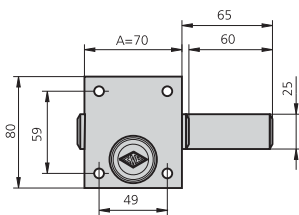
DESCRIPCIÓN	REF.	MEDIDAS		CILINDRO	ACABADOS		UDS		PRECIO	
		B	A		FRENTE	CILINDRO			COMPLETA	S/CILINDRO



1978/0	35	70	Ø 26mm	HN	CL	1	20		
1978/1	35	70	Ø 26mm	HE	CL	1	20		

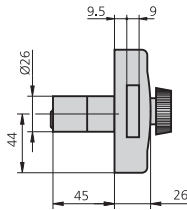

**CARACTERÍSTICAS**

- Cerrojo de seguridad reversible
- Palanca deslizante de acero accionable por llave desde el exterior y mediante pomo desde el interior
- Cilindro exterior redondo diámetro 26mm
- Dos acabados: hierro esmaltado y hierro niquelado
- Cerradero CE1988/1 ó CE1988/0
- Embellecedor ES1125
- Componentes de sujeción

**ACCESORIOS OPCIONALES**

- Cilindro de seguridad
- Cilindros de distintas longitudes

**DESCRIPCIÓN**

REF.	MEDIDAS		CILINDRO	ACABADOS		UDS		PRECIO	
	B	A		FRENTE	CILINDRO			COMPLETA	S/CILINDRO
1988/0	56	56	Ø 26mm	HN	CL	1	24		
1988/1	56	56	Ø 26mm	HE	CL	1	24		

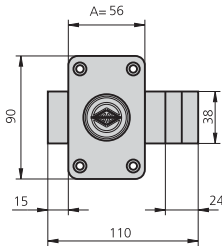



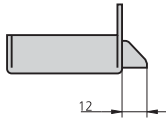

**CARACTERÍSTICAS**

- Picaporte reversible de sobreponer
- Picaporte accionable mediante manilla
- Cuadradillo para manilla de 8mm
- Acabado en hierro esmaltado
- Cerradero CE234/1
- Embellecedor ES234

**ACCESORIOS OPCIONALES**

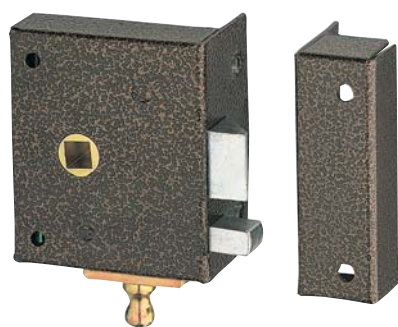
DESCRIPCIÓN	REF.	MEDIDAS			CILINDRO		ACABADOS		UDS		PRECIO	
		B	A		FRENTE	CILINDRO			COMPLETA	S/CILINDRO		
	234/50/1	30	50	-	HE		6	120				
	234/60/1	38	60	-	HE		6	120				
	234/70/1	46	70	-	HE		6	120				



CARACTERÍSTICAS

- Picaporte reversible de sobreponer
- Condena accionable mediante tirador
- Cuadradillo para manilla de 8mm
- Acabado en hierro esmaltado
- Cerradero CE236/1
- Embellecedor ES234

ACCESORIOS OPCIONALES

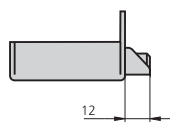

DESCRIPCIÓN

REF.	MEDIDAS CILINDRO		ACABADOS FRENTE CILINDRO	UDS		PRECIO	
	B	A				COMPLETA	S/CILINDRO

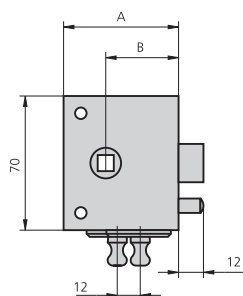

236/50/1	30	50	-	HE	6	120		
236/60/1	38	60	-	HE	6	120		
236/70/1	46	70	-	HE	6	120		

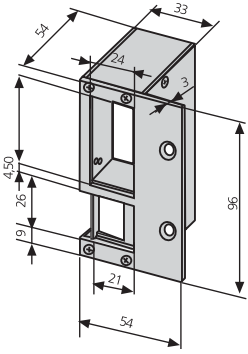
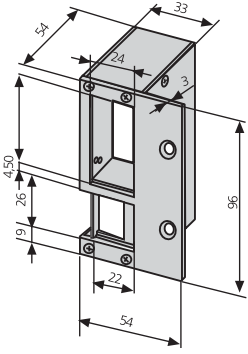
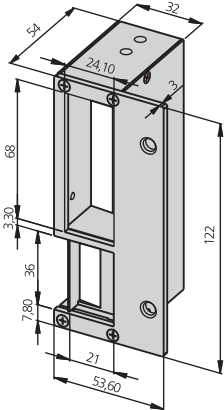
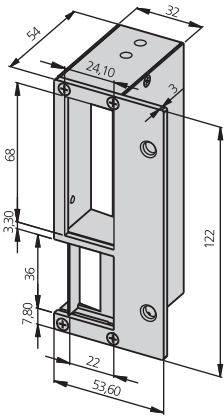
DESCRIPCIÓN	REF.	PARA	PRECIO	
			COMPLETA	S/CILINDRO
 <ul style="list-style-type: none"> <li>Cerradero eléctrico reversible de 96mm con sujeción oculta para cerraduras horizontales con cerrojo (RF. 125) que tengan un espesor de 20mm</li> </ul>	CELC125/1A	125, 1125		
 <ul style="list-style-type: none"> <li>Cerradero eléctrico reversible de 96mm con sujeción oculta para cerraduras horizontales con cerrojo (RF. 125) que tengan un espesor superior a 20mm</li> </ul>	CELC125/1BA	125, 1125		
 <ul style="list-style-type: none"> <li>Cerradero eléctrico reversible de 122mm con sujeción oculta para cerraduras horizontales con cerrojo (ref. 56) que tengan un espesor de 20mm</li> </ul>	CELC56/1A	56, 156		
 <ul style="list-style-type: none"> <li>Cerradero eléctrico reversible de 122mm con sujeción oculta para cerraduras horizontales con cerrojo (ref. 56) que tengan un espesor superior a 20mm</li> </ul>	CELC56/1BA	56, 156		



## CERRADURAS DE EMBUTIR PARA CARPINTERÍA DE MADERA

<b>Cerraduras de seguridad con palanca de bulones</b>	<b>104</b>
• Serie 4000	104
<b>Cerradura multipunto de seguridad con palanca de bulones</b>	<b>105</b>
• Serie 4100	105
<b>Cerraduras de palanca rectangular deslizante</b>	<b>107</b>
• Serie 1985	107
• Serie 1970	108
• Serie 1960	110
• Serie 1961	111
• Serie 1962	112
• Serie 62 y 63R	113
<b>Picaportes</b>	<b>114</b>
• Serie 943	114
• Serie 942	115
• Serie 249	116
<b>Accesorios</b>	<b>117</b>
• Cerraderos para cerraduras para puertas de madera	117
• Escudos	119
• Escudos de seguridad	119

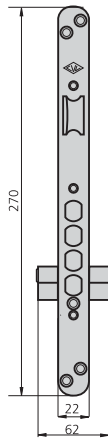

**CARACTERÍSTICAS**

- Cerradura de seguridad de 1 punto y palanca de 4 bulones de acero
- Entre ejes 85mm
- Frente de hierro latonado o acero inoxidable disponible en canto redondo y canto cuadrado
- Picaporte reversible accionable mediante llave y manilla
- Cerradero de hierro latonado o acero inoxidable disponible en canto redondo y canto cuadrado
- Escudo protector de cilindro
- Cilindro de seguridad

**ACCESORIOS OPCIONALES**

- Amplia gama de cilindros (ver página 127 - 148)

**DESCRIPCIÓN**

REF.	MEDIDAS B A	LEVA	ACABADOS FRENTE	CANTO CILINDRO	UDS  	PRECIO COMPLETA S/CILINDRO
------	----------------	------	--------------------	-------------------	--------------------------------------------------------------------------------------------------------------------------------------------------------------------------------	-------------------------------

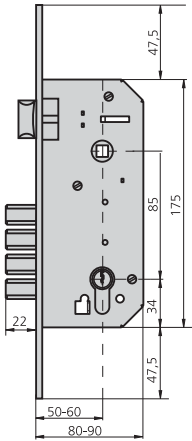

- Picaporte y palanca de 4 bulones de acero
- Cilindro de seguridad 6982/2525

4000/50/2ZB	50 80	15	HL	CL	Red	1 12		
4000/50/6ZB	50 80	15	Al	CN	Red	1 12		
4001/50/2ZB	50 80	15	HL	CL	Cua	1 12		
4001/50/6ZB	50 80	15	Al	CN	Cua	1 12		
4000/60/2ZB	60 90	15	Al	CN	Red	1 12		
4000/60/6ZB	60 90	15	Al	CN	Red	1 12		
4001/60/2ZB	60 90	15	HL	CL	Cua	1 12		
4001/60/6ZB	60 90	15	Al	CN	Cua	1 12		

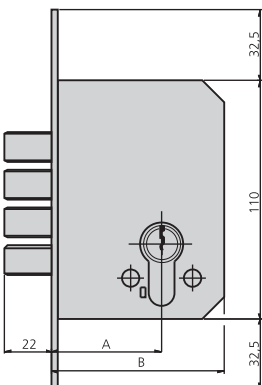

- Cerradura con sólo palanca de 4 bulones de acero
- Cilindro de seguridad 6982/2525

4000A50/2ZB	50 80	15	HL	CL	Red	1 12		
4000A50/6ZB	50 80	15	Al	CN	Red	1 12		
4001A50/2ZB	50 80	15	HL	CL	Cua	1 12		
4001A50/6ZB	50 80	15	Al	CN	Cua	1 12		
4000A60/2ZB	60 90	15	HL	CL	Red	1 12		
4000A60/6ZB	60 90	15	Al	CN	Red	1 12		
4001A60/2ZB	60 90	15	HL	CL	Cua	1 12		
4001A60/6ZB	60 90	15	Al	CN	Cua	1 12		

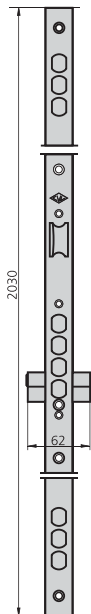
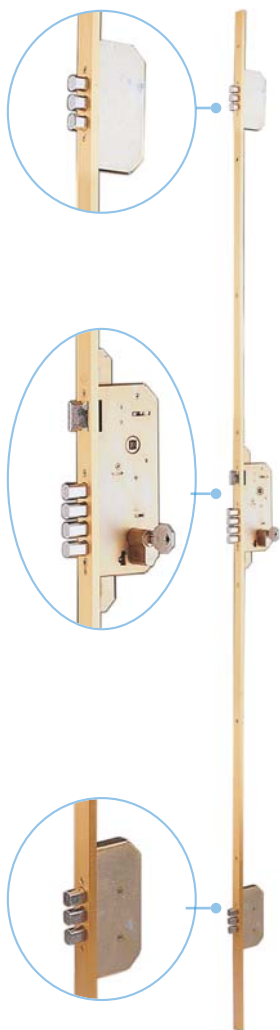
**CARACTERÍSTICAS**

- Cerradura de alta seguridad de 3 puntos de cierre mediante 10 bulones de acero
- Entre ejes 85mm
- Frente largo de acero pintado dorado
- Picaporte reversible accionable mediante llave y manilla
- 3 cerraderos cortos de acero pintado dorado
- Escudo protector de cilindro de seguridad pintado dorado
- Cilindro de seguridad

**ACCESORIOS OPCIONALES**

- Amplia gama de cilindros (ver página 127 - 148)

DESCRIPCIÓN	REF.	MEDIDAS		LEVA	ACABADOS		UDS		PRECIO	
		B	A		FRENTE	CILINDRO			COMPLETA	S/CILINDRO

- Cerradura de 3 puntos
- Cilindro de seguridad ref. 6982/2525/3

4100/50/1D	50	80	15	HE	CL	1				
4100/60/1D	60	90	15	HE	CL	1				

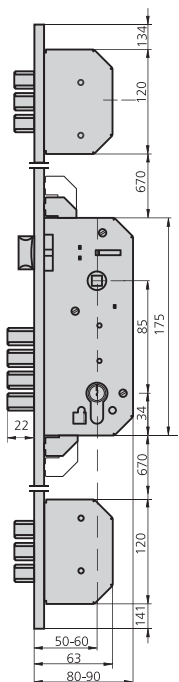

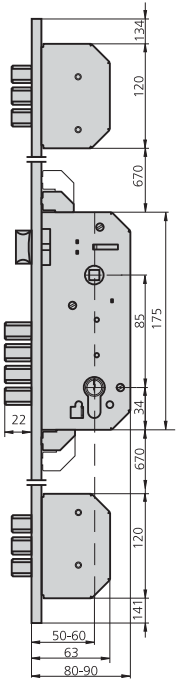

- Cerradura antipánico de 3 puntos
- Cilindro de seguridad ref. 6982/2525/3

DESCRIPCIÓN	REF.	MEDIDAS		LEVA	ACABADOS		UDS	PRECIO	
		B	A		FRENTE	CILINDRO		COMPLETA	S/CILINDRO
	4110/50D/1D	50	80	15	HE	CL	1		
	4110/50I/1D	50	80	15	HE	CL	1		
	4110/60D/1D	60	90	15	HE	CL	1		
	4110/60I/1D	60	90	15	HE	CL	1		



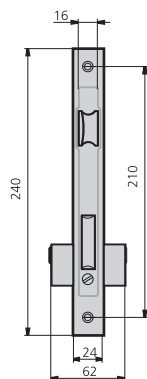

**CARACTERÍSTICAS**

- Entre ejes 85mm
- Frente de hierro latonado o acero inoxidable
- Picaporte reversible accionable mediante llave y manilla
- Palanca deslizante a dos vueltas de llave
- Cerradero según cerradura
- Embellecedor ES1960
- Componentes de sujeción
- Cilindro europerfil

**ACCESORIOS OPCIONALES**

- Amplia gama de cilindros (ver página 127 - 148)

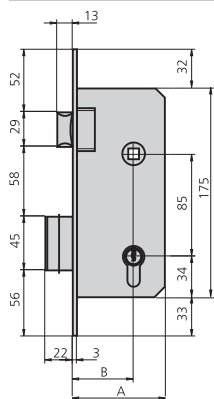
DESCRIPCIÓN	REF.	MEDIDAS		LEVA	ACABADOS		UDS		PRECIO	
		B	A		FRENTE	CILINDRO			COMPLETA	S/CILINDRO



- Cerradura con resbalón y palanca
- Cilindro de leva larga 5982/2525
- Cerradero CE1985/2 ó CE1985/6

1985/40/2	40	68	15	HL	CL	1	12		
1985/40/6	40	68	15	AI	CN	1	12		
1985/50/2	50	78	15	HL	CL	1	12		
1985/50/6	50	78	15	AI	CN	1	12		
1985/60/2	60	88	15	HL	CL	1	12		
1985/60/6	60	88	15	AI	CN	1	12		

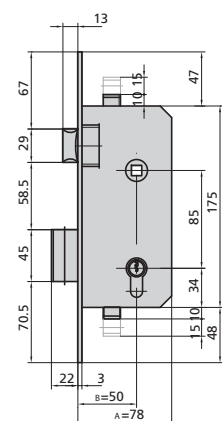

- Cerradura con picaporte y palanca
- 3 puntos de cierre
- Cilindro de leva larga 5982/2525
- Cerradero CE1985/2 ó CE1985/6

1985/3P/2	50	78	15	HL	CL	1	12		
-----------	----	----	----	----	----	---	----	--	--

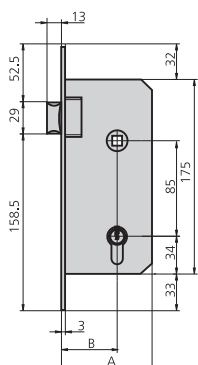

- Cerradura de sólo picaporte
- Con medio cilindro 5982T40
- Cerradero CE1970R/2 ó CE1970R/6

1985T40/2	40	68	15	HL	CL	1	12		
1985T40/6	40	68	15	AI	CN	1	12		
1985T50/2	50	78	15	HL	CL	1	12		
1985T50/6	50	78	15	AI	CN	1	12		
1985T60/2	60	88	15	HL	CL	1	12		
1985T60/6	60	88	15	AI	CN	1	12		

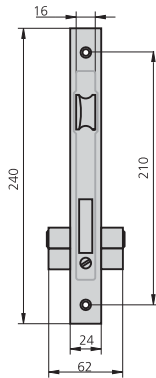

**CARACTERÍSTICAS**

- Entre ejes 70mm
- Frente de hierro latonado o acero inoxidable
- Picaporte reversible accionable mediante llave y manilla
- Palanca deslizante a dos vueltas de llave
- Cerradero según cerradura
- Embellecedor ES1960
- Componentes de sujeción
- Cilindro europerfil

**ACCESORIOS OPCIONALES**

- Amplia gama de cilindros (ver página 127 - 148)

**DESCRIPCIÓN**

REF.	MEDIDAS		LEVA	ACABADOS		UDS		PRECIO	
	B	A		FRENTE	CILINDRO			COMPLETA	S/CILINDRO

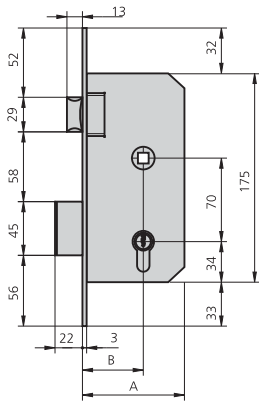

- Cerradura con picaporte y palanca
- Cilindro de leva larga 5982/2525
- Cerradero CE1985/2 ó CE1985/6

1970/40/2	40	68	15	HL	CL	1	12		
1970/40/6	40	68	15	AI	CN	1	12		
1970/50/2	50	78	15	HL	CL	1	12		
1970/50/6	50	78	15	AI	CN	1	12		
1970/60/2	60	88	15	HL	CL	1	12		
1970/60/6	60	88	15	AI	CN	1	12		

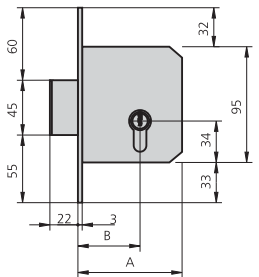

- Cerradura con sólo palanca
- Cilindro de leva larga 5982/2525
- Cerradero CE1970A/2 ó CE1970A/6

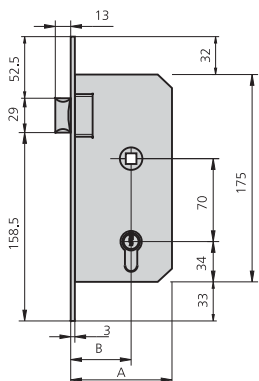

1970A40/2	40	68	15	HL	CL	1	20		
1970A40/6	40	68	15	AI	CN	1	20		
1970A50/2	50	78	15	HL	CL	1	20		
1970A50/6	50	78	15	AI	CN	1	20		
1970A60/2	60	88	15	HL	CL	1	20		
1970A60/6	60	88	15	AI	CN	1	20		



- Cerradura de sólo picaporte
- Con medio cilindro 5982T40
- Cerradero CE1970R/2 ó CE1970R/6

1970T40/2	40	68	15	HL	CL	1	12		
1970T40/6	40	68	15	AI	CN	1	12		
1970T50/2	50	78	15	HL	CL	1	12		
1970T50/6	50	78	15	AI	CN	1	12		
1970T60/2	60	88	15	HL	CL	1	12		
1970T60/6	60	88	15	AI	CN	1	12		

**CERRADURAS DE PALANCA RECTANGULAR DESLIZANTE**
**SERIE 1970**

DESCRIPCIÓN	REF.	MEDIDAS		LEVA	ACABADOS		UDS		PRECIO	
		B	A		FRENTE	CILINDRO			COMPLETA	S/CILINDRO
• Cerradura con rodillo y palanca	1970V40/2	40	68	15	HL	CL	1	12		
	1970V40/6	40	68	15	Al	CN	1	12		
• Con cilindro 5982/2525	1970V50/2	50	78	15	HL	CL	1	12		
	1970V50/6	50	78	15	Al	CN	1	12		
• Cerradero CE1985/2 ó CE1985/6	1970V60/2	60	88	15	HL	CL	1	12		
	1970V60/6	60	88	15	Al	CN	1	12		

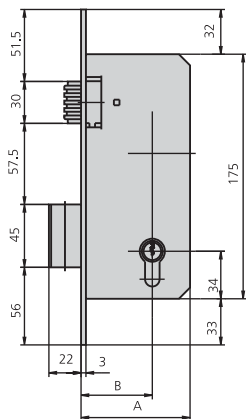

- Cerradura con rodillo y palanca
- Con cilindro 5982/2525
- Cerradero CE1985/2 ó CE1985/6

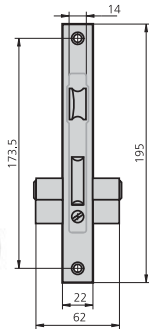

**CARACTERÍSTICAS**

- Entre ejes 48mm
- Frente de hierro latonado o acero inoxidable
- Picaporte reversible accionable mediante llave y manilla
- Palanca deslizante accionado por una vuelta de llave
- Cerradero según cerradura
- Embellecedor ES1960
- Componentes de sujeción
- Cilindro europerfil

**ACCESORIOS OPCIONALES**

- Amplia gama de cilindros (ver página 127 - 148)

**DESCRIPCIÓN**

REF.	MEDIDAS		LEVA	ACABADOS		UDS		PRECIO	
	B	A		FRENTE	CILINDRO			COMPLETA	S/CILINDRO

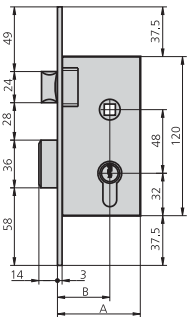

- Cerradura con picaporte y palanca
- Cilindro de leva larga 5982/2525
- Cerradero CE1960/2 ó CE1960/6

1960/60/2	40	62	15	HL	CL	1	20		
1960/60/6	40	62	15	AI	CN	1	20		
1960/70/2	50	72	15	HL	CL	1	20		
1960/70/6	50	72	15	AI	CN	1	20		

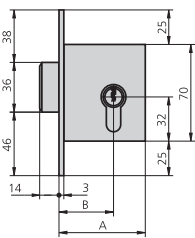

- Cerradura con sólo palanca
- Cilindro de leva larga 5982/2525
- Cerradero CE1960A/2 ó CE1960A/6

1960A60/2	40	62	15	HL	CL	1	30		
1960A60/6	40	62	15	AI	CN	1	30		
1960A70/2	50	72	15	HL	CL	1	30		
1960A70/6	50	72	15	AI	CN	1	30		

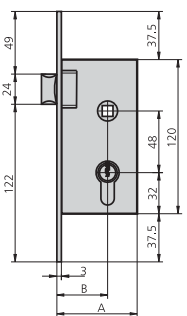

- Cerradura de sólo picaporte
- Con medio cilindro 5982T40
- Cerradero CE249R/2 ó CE249R/6

1960T60/2	40	62	15	HL	CL	1	20		
1960T60/6	40	62	15	AI	CN	1	20		
1960T70/2	50	72	15	HL	CL	1	20		
1960T70/6	50	72	15	AI	CN	1	20		

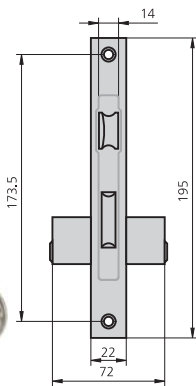

**CARACTERÍSTICAS**

- Frente de hierro latonado
- Picaporte reversible accionable mediante llave y manilla
- Palanca deslizante accionado por llave
- Cerradero según cerradura
- Embellecedor ES1964
- Componentes de sujeción
- Cilindro ovalado 5961/2525/3

**ACCESORIOS OPCIONALES**

- Amplia gama de cilindros (ver página 127 - 148)

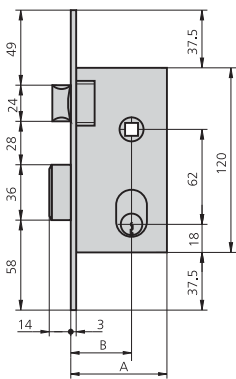
DESCRIPCIÓN	REF.	MEDIDAS		LEVA	ACABADOS		UDS		PRECIO	
		B	A		FRENTE	CILINDRO			COMPLETA	S/CILINDRO



- Cerradura con picaporte y palanca
- Cerradero CE1960/2

1961/60/2	40	62		HL	CL	1	20		
1961/70/2	50	72		HL	CL	1	20		

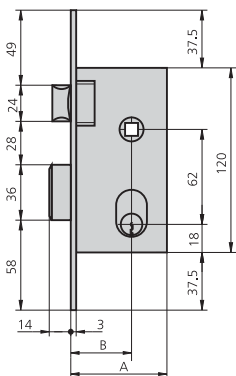

- Cerradura con sólo palanca
- Cerradero CE1960A/2

1961A60/2	40	62		HL	CL	1	20		
1961A70/2	50	72		HL	CL	1	20		

CARACTERÍSTICAS

- Frente de hierro latonado
- Picaporte reversible accionable mediante llave y manilla
- Palanca deslizante accionado por llave
- Cerradero según cerradura
- Embellecedor ES1962
- Componentes de sujeción
- Cilindro redondo

ACCESORIOS OPCIONALES

- Amplia gama de cilindros (ver página 127 - 148)

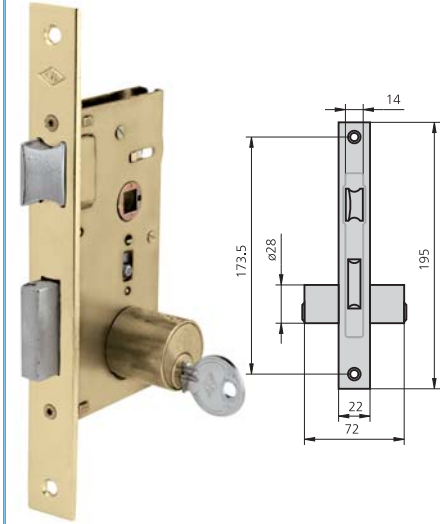

DESCRIPCIÓN

DESCRIPCIÓN	REF.	MEDIDAS		LEVA	ACABADOS		UDS		PRECIO	
		B	A		FRENTE	CILINDRO			COMPLETA	S/CILINDRO

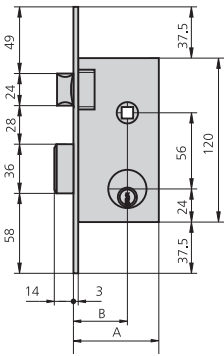

- Cerradura con picaporte y palanca
- Cilindro redondo 5962/2525/3
- Cerradero CE1960/2

1962/60/2	40	62		HL	CL	1	20		
1962/70/2	50	72		HL	CL	1	20		

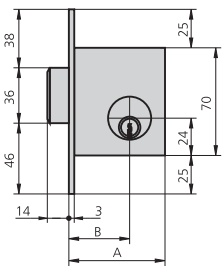

- Cerradura con sólo palanca
- Cilindro redondo 5962/2525/3
- Cerradero CE1960A/2

1962A60/2	40	62		HL	CL	1	30		
1962A70/2	50	72		HL	CL	1	30		

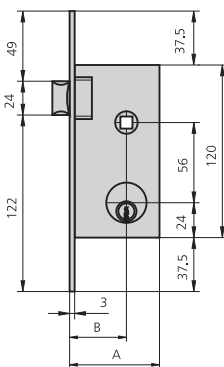

- Cerradura de sólo picaporte
- Medio cilindro redondo 5962T30/3
- Cerradero CE249R/2

1962T60/2	40	62		HL	CL	1	20		
1962T70/2	50	72		HL	CL	1	20		

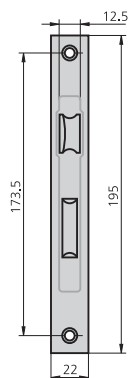
**CARACTERÍSTICAS**

- Frente de hierro latonado
- Picaporte reversible accionable mediante manilla
- Palanca deslizante accionado por llave gorja
- Cerradero según cerradura
- Componentes de sujeción

**ACCESORIOS OPCIONALES**

DESCRIPCIÓN	REF.	MEDIDAS		LEVA	ACABADOS		UDS		PRECIO	
		B	A		FRENTE	CILINDRO			COMPLETA	S/CILINDRO

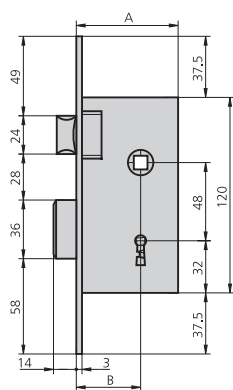

- Cerradura con picaporte y palanca
- Llave de gorja
- Cerradero CE1960/2

63R50/2	30	52	HL	1	20		
63R60/2	40	62	HL	1	20		
63R70/2	50	72	HL	1	20		

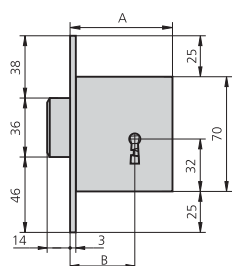

- Cerradura con sólo palanca
- Llave de gorja
- Cerradero CE1960A/2

62/50/2	30	52	HL	1	30		
62/60/2	40	62	HL	1	30		

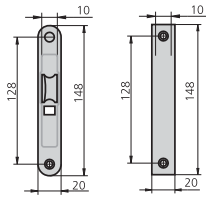

**CARACTERÍSTICAS**

- Picaporte unificado
- Frente de hierro latonado o níquel satinado
- Picaporte reversible accionable mediante manilla
- Condena a 47mm y a 70mm
- Cerradero CE942R30/2 ó CE942R30/7
- Componentes de sujeción

**ACCESORIOS OPCIONALES**

**DESCRIPCIÓN**

**REF.**

**MEDIDAS  
B A**

**ACABADOS  
FRENTE CILINDRO**

**CANTO**

**UDS**

**PRECIO**

COMPLETA S/CILINDRO

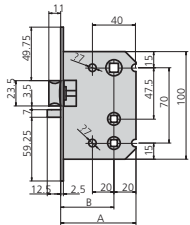

- Picaporte con condena
- Condena accionable mediante muletilla
- Canto redondo ó canto cuadrado

943/2R	50	70	HL	Red	1	30		
943/2C	50	70	HL	Cua	1	30		
943/7R	50	70	NS	Red	1	30		
943/7C	50	70	NS	Cua	1	30		

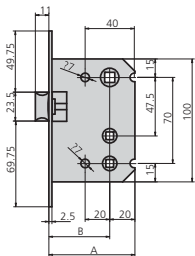

- Picaporte de paso
- Canto redondo o canto cuadrado

943P/2R	50	70	HL	Red	1	30		
943P/2C	50	70	HL	Cua	1	30		
943P/7R	50	70	NS	Red	1	30		
943P/7C	50	70	NS	Cua	1	30		



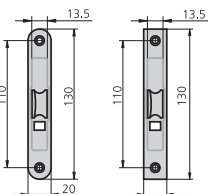

**CARACTERÍSTICAS**

- Frente de hierro latonado
- Picaporte reversible accionable mediante manilla
- Condena a 47mm
- Cerradero CE942R30/2
- Componentes de sujeción

**ACCESORIOS OPCIONALES**

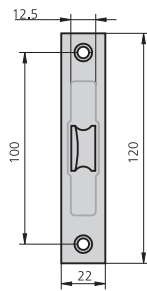
DESCRIPCIÓN	REF.	MEDIDAS		ACABADOS		CANTO	UDS		PRECIO	
		B	A	FRENTE	CILINDRO				COMPLETA	S/CILINDRO
<ul style="list-style-type: none"> <li>• Picaporte con condena</li> <li>• Condena accionable mediante muletilla</li> <li>• Canto redondo ó canto cudadrado</li> </ul>	942RC/R/2	50	67	HL		Red	1	30		
	942RC/C/2	50	67	HL		Cua	1	30		
<ul style="list-style-type: none"> <li>• Picaporte de paso</li> <li>• Canto redondo o canto cudadrado</li> </ul>	942R/R/2	50	67	HL		Red	1	30		
	942R/C/2	50	67	HL		Cua	1	30		



CARACTERÍSTICAS

- Frente de hierro latonado
- Picaporte reversible accionable mediante manilla
- Cerradero según cerradura
- Componentes de sujeción

ACCESORIOS OPCIONALES

DESCRIPCIÓN

REF.

MEDIDAS  
B A

ACABADOS  
FRENTE CILINDRO

CANTO

UDS  
 

PRECIO

COMPLETA S/CILINDRO

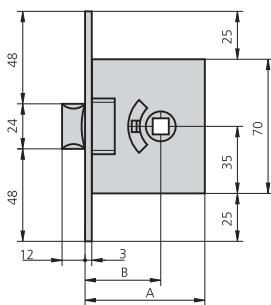

- Cerradura reversible 249B50/2
- Picaporte accionable mediante manilla 249B60/2
- Cerradero CE249R/2

249B50/2	37	52	HL	1	20		
249B60/2	44	62	HL	1	20		

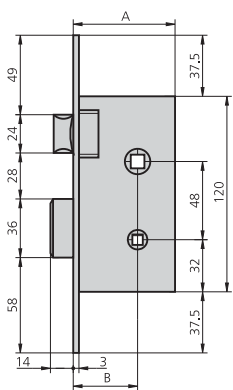

- Cerradura con picaporte y palanca 249C50/2
- Con condena 249C60/2
- Cerradero CE1960/2

249C50/2	30	52	HL	1	20		
249C60/2	40	62	HL	1	20		
249C70/2	50	72	HL	1	20		

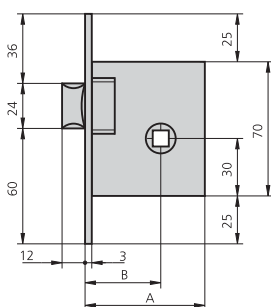



- Picaporte reversible accionable mediante manilla 249R50/2
- 249R60/2
- 249R70/2
- Cerradero CE249R/2

249R50/2	30	52	HL	1	30		
249R60/2	40	62	HL	1	30		
249R70/2	50	72	HL	1	30		

**ACCESORIOS**

**CERRADEROS**

DESCRIPCIÓN	REF.	ACABADO	APLICABLE A CERRADURAS	UDS  	PRECIO COMPLETA S/CILINDRO
-------------	------	---------	------------------------	-----------------------------------------------------------------------------------------------------------------------------------------------------------------------------	----------------------------

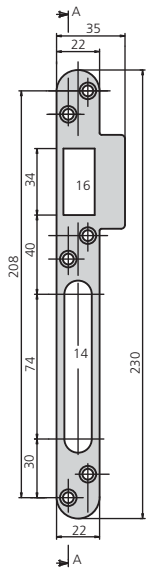

CE4000/2	HL	4000, 4010		
CE4000/6	AI			

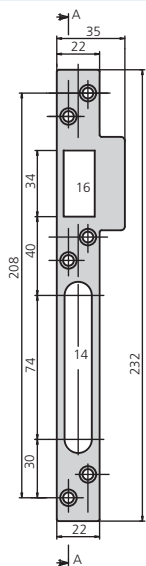

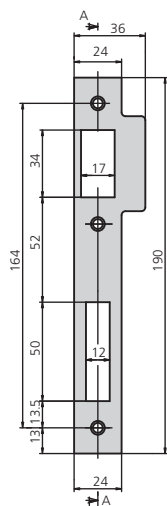

CE4001/2	HL	4001, 4011		
CE4001/6	AI			



CE1985/2	HL	1970, 1970C, 1970V		
CE1985/6	AI	1985, 1985C, 1985/3P		

EMBUTIR PARA MADERA

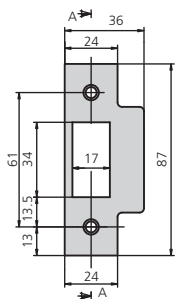
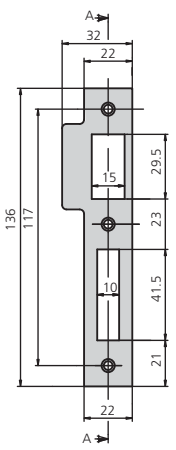
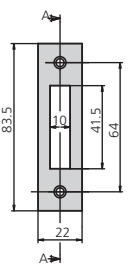
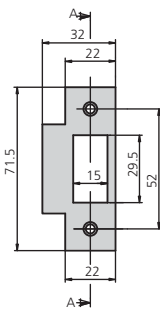
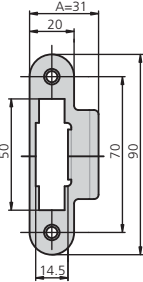
DESCRIPCIÓN	REF.	ACABADO	APLICABLE A CERRADURAS	UDS  	PRECIO COMPLETA S/CILINDRO
	CE1970R/2 CE1970R/6	HL Al	1970T, 1985T		
	CE1960/2 CE1960/6	HL Al	1960, 1961, 1962, 249C, 63R		
	CE1960A/2 CE1960A/6	HL Al	1960A, 1961A, 1962A,		
	CE249R/2 CE249R/6	HL Al	1960T, 1962T, 249B, 249R		
	CE942R25/2 CE942R30/2 CE942R30/7 CE942R35/2 CE942R35/7	HL HL NS HL NS	943/R, 943P/R, 942C/R, 942R/R, 942RC/R		

**ACCESORIOS**
**CERRADEROS**

DESCRIPCIÓN	REF.	ACABADO	APLICABLE A CERRADURAS	UDS	PRECIO COMPLETA S/CILINDRO
	CE942C30/2	HL	942/C, 943P/C, 942C/C,		
	CE942C35/2	HL	942R/C, 942RC/C		

**ACCESORIOS**
**ESCUDOS**

DESCRIPCIÓN	REF.	ACABADO	APLICABLE A CERRADURAS	UDS	PRECIO COMPLETA S/CILINDRO
	ES1960	LP	1960, 1970, 1985, 156		
	ES1960/4	LN			
	ES1962	LP	1962, 11981		
	ES1962/4	LN			
	ES1964	Escudo de nylon	1961		

**ACCESORIOS**
**ESCUDOS DE SEGURIDAD**

DESCRIPCIÓN	REF.	ACABADO	APLICABLE A CERRADURAS	UDS	PRECIO COMPLETA S/CILINDRO
	KES4000		4000, 4001, 4010, 4011, 4100, 4110		



## Cerraduras para PVC

	<b>Cerraduras para PVC</b>	122
	• Serie P192	122
	<b>Multipunto palanca deslizante entre ejes 92mm</b>	123
	• Serie P2E2N	123
	• Serie P202N	124
	<b>Accesorios</b>	125
• Cerraderos	125	

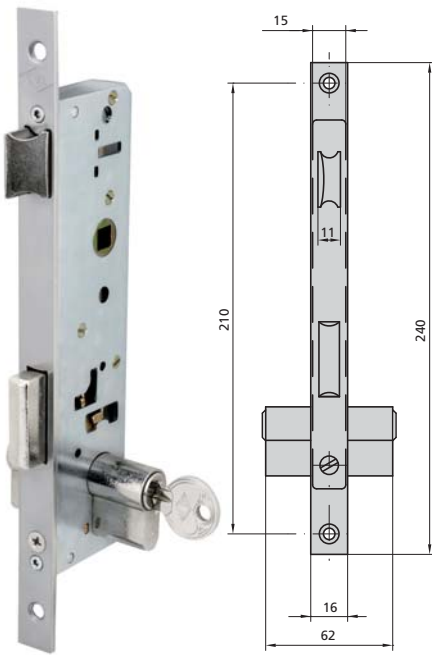

**CARACTERÍSTICAS**

- Frente liso inox de 16mm
- Picaporte reversible de 11mm
- Caja zincada de 15mm
- Cudradillo de 8mm
- 2 escudos de nylon ref. ES1984
- Tornillo de fijación de cilindro

**ACCESORIOS OPCIONALES**

- Amplia gama de cilindros (ver página 127 - 148)

**DESCRIPCIÓN**

REF. MEDIDAS LEVA ACABADOS UDS. PRECIO  
 B A FRENTE CILINDRO COMPLETA S/CILINDRO

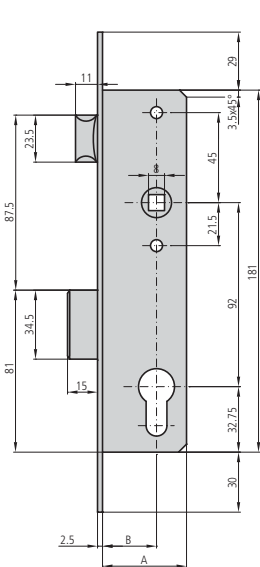

- Picaporte y palanca deslizante
- Cilindro europerfil leva DIN

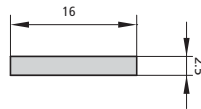

REF.	B	A	LEVA	ACABADOS FRENTE CILINDRO	UDS.	PRECIO COMPLETA S/CILINDRO
P192/25/6	22	37	15	Al CN	1 20	
P192/30/6	27	42	15	Al CN	1 20	
P192/35/6	32	47	15	Al CN	1 20	



# MULTIPUNTO PALANCA DESLIZANTE ENTRE EJES 92MM

# SERIE P2E2N

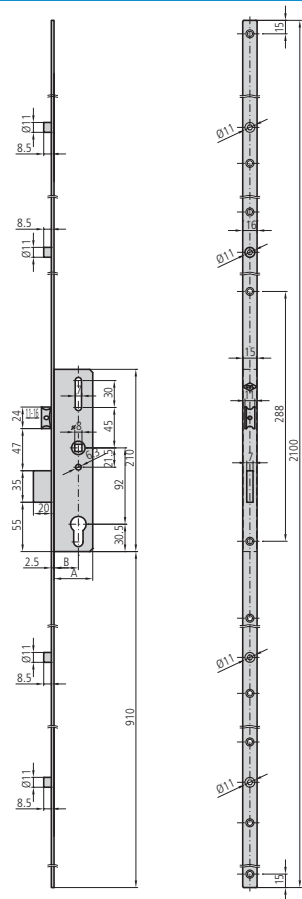

### CARACTERÍSTICAS

- Cerradura para PVC de 3 puntos con mecanismo de engranajes
- Frente liso en acero zincado trivalente de 16mm\*2100mm
- Cierre mediante palancas deslizante central y 4 rodillos
- Mínimo stock: 3 versiones en 1 cerradura (picaporte/rodillo/solo palanca)
- Picaporte de 11mm reversible y regulable
- Diseñado según norma EN 12209 Y pr 15685
- Caja cerrada de 15mm
- Cuadradillo de 8mm
- Cerradores de serie
- Tornillo de fijación de cilindro

### ACCESORIOS OPCIONALES

- Amplia gama de cilindros (ver página 127 - 148)

DESCRIPCIÓN	REF.	MEDIDAS		LEVA	ACABADOS	UDS	PRECIO	
		B	A				FRENTE CILINDRO	COMPLETA S/CILINDRO

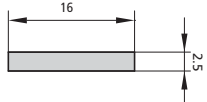
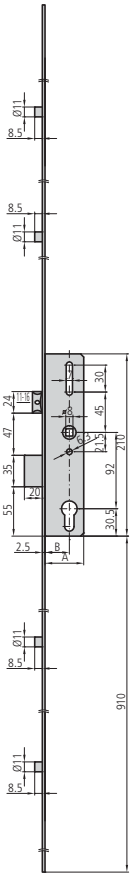

- Picaporte y palanca
  - No incluye cilindro
- Cerradores de serie**
- Central CEP202N/8D ó CEP202N/8I

P2E2N/30/8	27	42	15	Z	CN	1		
P2E2N/35/8	32	47	15	Z	CN	1		
P2E2N/40/8	37	53	15	Z	CN	1		
P2E2N/45/8	42	58	15	Z	CN	1		
P2E2N/50/8	47	63	15	Z	CN	1		

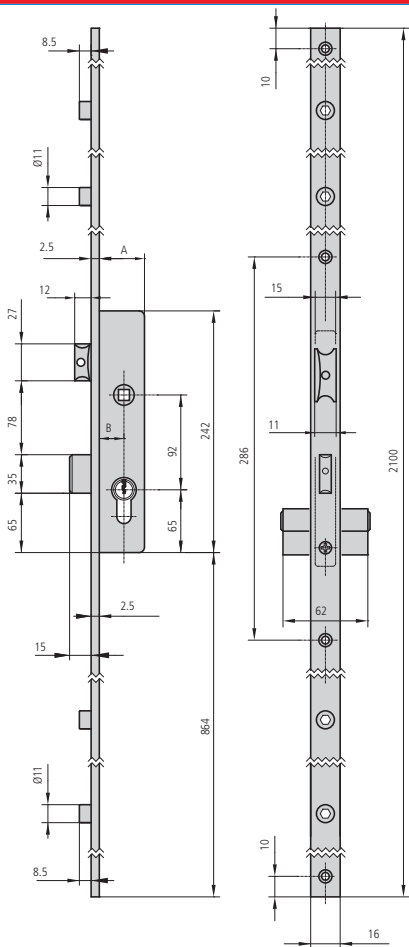

**CARACTERÍSTICAS**

- Cerradura para PVC de 3 puntos con facilidad de cierre mediante manilla hacia arriba y bloqueo mediante llave
- Cierre mediante 4 rodillos regulables
- Frente liso de 16mm en acero zincado trivalente
- Frente de 2100mm de largo
- Picaporte de 11mm reversible y regulable
- Palanca central deslizante reforzada
- Caja cerrada de 15mm
- Cuadradillo de 8mm
- Cerraderos de serie
- Tornillo de fijación de cilindro

**ACCESORIOS OPCIONALES**

- Amplia gama de cilindros (ver página 127 - 148)

**DESCRIPCIÓN**

REF.	MEDIDAS B	MEDIDAS A	LEVA	ACABADOS FRENTE	ACABADOS CILINDRO	UDS	PRECIO COMPLETA	PRECIO S/CILINDRO
------	-----------	-----------	------	-----------------	-------------------	-----	-----------------	-------------------

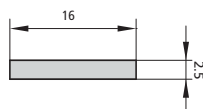
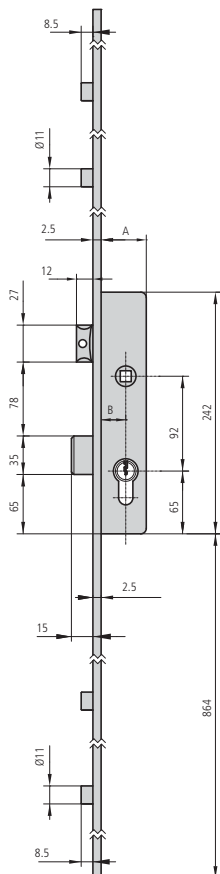



- Picaporte y palanca
- No incluye cilindro

P202N/30/8	27	42	15	Z	CN	1		
P202N/35/8	32	47	15	Z	CN	1		

**Cerraderos de serie**

- Central CEP202N/8D ó CEP202N/8I

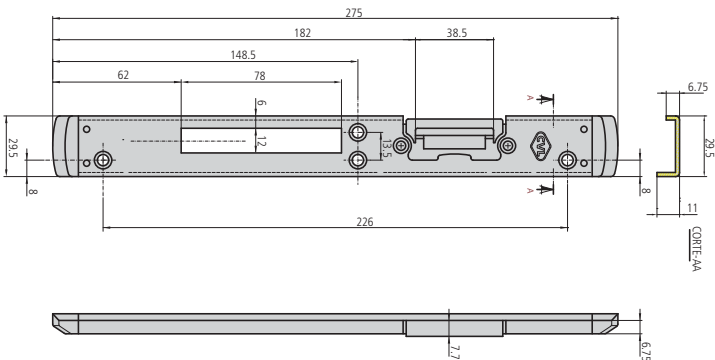
DESCRIPCIÓN	REF.	ACABADO	APLICABLE A CERRADURAS	UDS  	PRECIO COMPLETA S/CILINDRO
					
<ul style="list-style-type: none"> <li>Cerradero regulable de acero zincado trivalente, mano derecha</li> </ul>	CEP202N/8D	Z	P2E2N, P202N		
<ul style="list-style-type: none"> <li>Cerradero regulable de acero zincado trivalente, mano izquierda</li> </ul>	CEP202N/8I	Z			



## CILINDROS

<b>Cilindro europerfil normal leva larga</b>	<b>128</b>
• Serie 5982	128
• Serie 5982P	130
• Serie 5982T	130
• Serie 5982PT	131
<b>Cilindro europerfil normal leva corta</b>	<b>132</b>
• Serie 5990	132
• Serie 5990P	134
• Serie 5990T	134
• Serie 5990PT	135
<b>Cilindro europerfil de seguridad leva larga</b>	<b>136</b>
• Serie 6982	136
• Serie 6982P	138
• Serie 6982T	138
<b>Cilindro europerfil de seguridad leva corta</b>	<b>139</b>
• Serie 6990	139
• Serie 6990P	141
• Serie 6990T	141
<b>Cilindros ovalados y redondos</b>	<b>142</b>
• Serie 5963	142
• Serie 5081	143
• Serie 5961	144
• Serie 5962	145
• Serie 5964	146
• Serie 5968	147
• Serie 5979	148

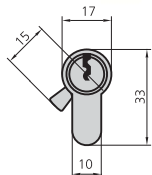



CARACTERÍSTICAS

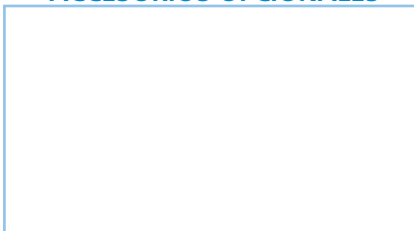

- Cuerpo de latón
- Rotores de latón
- Leva larga de 15mm
- 5 pitones
- 3 llaves

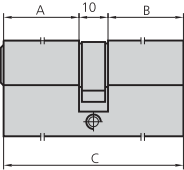
ACCESORIOS OPCIONALES



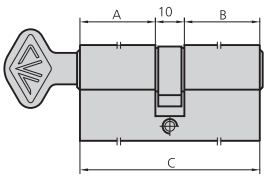
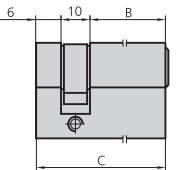
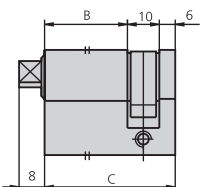

DESCRIPCIÓN	REF.	MEDIDAS			ACABADOS	UDS	PRECIO	
		A	B	C			COMPLETA	S/CILINDRO
 <ul style="list-style-type: none"> <li>• Cilindro doble</li> </ul>	5982/2525/3	26	26	62	LP	1		
	5982/2525/4	26	26	62	LN	1		
	5982/2530/3	26	31	67	LP	1		
	5982/2530/4	26	31	67	LN	1		
	5982/2535/3	26	36	72	LP	1		
	5982/2535/4	26	36	72	LN	1		
	5982/3030/3	31	31	72	LP	1		
	5982/3030/4	31	31	72	LN	1		
	5982/2540/3	26	41	77	LP	1		
	5982/2540/4	26	41	77	LN	1		
	5982/3035/3	31	36	77	LP	1		
	5982/3035/4	31	36	77	LN	1		
	5982/2545/3	26	46	82	LP	1		
	5982/2545/4	26	46	82	LN	1		
	5982/3040/3	31	41	82	LP	1		
	5982/3040/4	31	41	82	LN	1		
	5982/3535/3	36	36	82	LP	1		
	5982/3535/4	36	36	82	LN	1		
	5982/2550/3	26	51	87	LP	1		
	5982/2550/4	26	51	87	LN	1		
5982/3540/3	36	41	87	LP	1			
5982/3540/4	36	41	87	LN	1			
5982/3045/3	31	46	87	LP	1			
5982/3045/4	31	46	87	LN	1			
5982/2555/3	26	56	92	LP	1			
5982/2555/4	26	56	92	LN	1			
5982/3050/3	31	51	92	LP	1			
5982/3050/4	31	51	92	LN	1			
5982/3545/3	36	46	92	LP	1			
5982/3545/4	36	46	92	LN	1			
5982/4040/3	41	41	92	LP	1			
5982/4040/4	41	41	92	LN	1			
5982/2560/3	26	61	97	LP	1			
5982/2560/4	26	61	97	LN	1			
5982/3055/3	31	56	97	LP	1			
5982/3055/4	31	56	97	LN	1			
5982/2565/3	26	66	102	LP	1			
5982/2565/4	26	66	102	LN	1			
5982/3060/3	31	61	102	LP	1			
5982/3060/4	31	61	102	LN	1			
5982/3555/3	36	56	102	LP	1			
5982/3555/4	36	56	102	LN	1			

DESCRIPCIÓN	REF.	MEDIDAS			ACABADOS	UDS  	PRECIO	
		A	B	C			COMPLETA	S/CILINDRO
5982/4050/3	41	51	102	LP	1			
5982/4050/4	41	51	102	LN	1			
5982/4545/3	46	46	102	LP	1			
5982/4545/4	46	46	102	LN	1			
5982/4055/3	41	56	107	LP	1			
5982/4055/4	41	56	107	LN	1			
5982/2575/3	26	76	112	LP	1			
5982/2575/4	26	76	112	LN	1			
5982/3565/3	36	66	112	LP	1			
5982/3565/4	36	66	112	LN	1			
5982/4060/3	41	61	112	LP	1			
5982/4060/4	41	61	112	LN	1			
5982/4555/3	46	56	112	LP	1			
5982/4555/4	46	56	112	LN	1			
5982/5050/3	51	51	112	LP	1			
5982/5050/4	51	51	112	LN	1			
5982/2585/3	26	86	122	LP	1			
5982/2585/4	26	86	122	LN	1			
5982/3080/3	31	81	122	LP	1			
5982/3080/4	31	81	122	LN	1			
5982/3575/3	36	76	122	LP	1			
5982/3575/4	36	76	122	LN	1			
5982/4070/3	41	71	122	LP	1			
5982/4070/4	41	71	122	LN	1			
5982/5555/3	56	56	122	LP	1			
5982/5555/4	56	56	122	LN	1			
5982/2595/3	26	96	132	LP	1			
5982/2595/4	26	96	132	LN	1			
5982/4080/3	41	81	132	LP	1			
5982/4080/4	41	81	132	LN	1			
5982/6060/3	61	61	132	LP	1			
5982/6060/4	61	61	132	LN	1			
5982/3595/3	36	96	142	LP	1			
5982/3595/4	36	96	142	LN	1			
5982/6565/3	66	66	142	LP	1			
5982/6565/4	66	66	142	LN	1			
5982/7070/3	71	71	152	LP	1			
5982/7070/4	71	71	152	LN	1			
5982/7575/3	76	76	162	LP	1			
5982/7575/4	76	76	162	LN	1			

DESCRIPCIÓN	REF.	MEDIDAS			ACABADOS	UDS  	PRECIO	
		A	B	C			COMPLETA	S/CILINDRO
<ul style="list-style-type: none"> <li>• Cilindro con pomo</li> </ul> 	5982P2525/3	26	26	62	LP	1		
	5982P2525/4	26	26	62	LN	1		
	5982P2530/3	26	31	67	LP	1		
	5982P2530/4	26	31	67	LN	1		
	5982P2535/3	26	36	72	LP	1		
	5982P2535/4	26	36	72	LN	1		
	5982P3030/3	31	31	72	LP	1		
	5982P3030/4	31	31	72	LN	1		
	5982P3525/3	36	26	72	LP	1		
	5982P3525/4	36	26	72	LN	1		
	5982P2540/3	26	41	77	LP	1		
	5982P2540/4	26	41	77	LN	1		
	5982P2545/3	26	46	82	LP	1		
	5982P2545/4	26	46	82	LN	1		
	5982P3535/3	36	36	82	LP	1		
	5982P3535/4	36	36	82	LN	1		
	5982P2550/3	26	51	87	LP	1		
	5982P2550/4	26	51	87	LN	1		
	5982P3045/3	31	46	87	LP	1		
	5982P3045/4	31	46	87	LN	1		
	5982P3540/3	36	41	87	LP	1		
	5982P3540/4	36	41	87	LN	1		
	5982P2555/3	26	56	92	LP	1		
	5982P2555/4	26	56	92	LN	1		
	5982P3545/3	36	46	92	LP	1		
	5982P3545/4	36	46	92	LN	1		
	5982P2560/3	26	61	97	LP	1		
	5982P2560/4	26	61	97	LN	1		
	5982P2565/3	26	66	102	LP	1		
	5982P2565/4	26	66	102	LN	1		
	<ul style="list-style-type: none"> <li>• Medio cilindro</li> </ul> 	5982T40/3	26	42	LP	1		
		5982T40/4	26	42	LN	1		
		5982T45/3	31	47	LP	1		
		5982T45/4	31	47	LN	1		
		5982T50/3	36	52	LP	1		
5982T50/4		36	52	LN	1			
5982T55/3		41	57	LP	1			
5982T55/4		41	57	LN	1			
5982T60/3		46	62	LP	1			
5982T60/4		46	62	LN	1			
5982T65/3		51	67	LP	1			
5982T65/4		51	67	LN	1			
<ul style="list-style-type: none"> <li>• Medio cilindro</li> <li>• Triángulo por un lado y ciego por el otro</li> </ul> 	5982PT2505/3	26	42	LP	1			
	5982PT2505/4	26	42	LN	1			

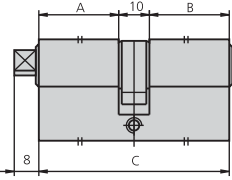

**CILINDRO EUROPERFIL NORMAL LEVA LARGA**
**SERIE 5982P, 5982T, 5982PT**

DESCRIPCIÓN	REF.	MEDIDAS			ACABADOS	UDS  	PRECIO	
		A	B	C			COMPLETA	S/CILINDRO
 <ul style="list-style-type: none"> <li>• Doble cilindro</li> <li>• Llave por un lado y triángulo por el otro</li> </ul>	5982PT2525/3	26	26	62	LP	1		
	5982PT2525/4	26	26	62	LN	1		
	5982PT2535/3	26	36	72	LP	1		
	5982PT2535/4	26	36	72	LN	1		
	5982PT2545/3	26	46	82	LP	1		
	5982PT2545/4	26	46	82	LN	1		

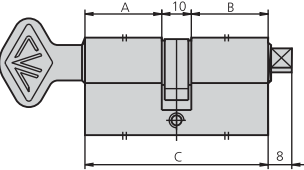

 <ul style="list-style-type: none"> <li>• Doble cilindro</li> <li>• Triángulo por un lado y pomo por el otro</li> </ul>	5982P25T25/3	26	26	62	LP	1		
	5982P25T25/4	26	26	62	LN	1		
	5982P30T30/3	31	31	72	LP	1		
	5982P30T30/4	31	31	72	LN	1		
	5982P35T25/3	36	26	72	LP	1		
	5982P35T25/4	36	26	72	LN	1		
	5982P35T35/3	36	36	82	LP	1		
	5982P35T35/4	36	36	82	LN	1		
	5982P30T45/3	31	46	87	LP	1		
	5982P30T45/4	31	46	87	LN	1		

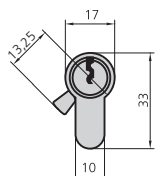

CARACTERÍSTICAS

- Cuerpo de latón
- Rotores de latón
- Leva corta de 13,25mm
- 5 pitones
- 3 llaves

ACCESORIOS OPCIONALES

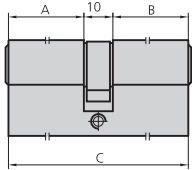

DESCRIPCIÓN	REF.	MEDIDAS			ACABADOS	UDS  	PRECIO	
		A	B	C			COMPLETA	S/CILINDRO
 <ul style="list-style-type: none"> <li>• Cilindro doble</li> </ul>	5990/2525/3	26	26	62	LP	1		
	5990/2525/4	26	26	62	LN	1		
	5990/2530/3	26	31	67	LP	1		
	5990/2530/4	26	31	67	LN	1		
	5990/2535/3	26	36	72	LP	1		
	5990/2535/4	26	36	72	LN	1		
	5990/3030/3	31	31	72	LP	1		
	5990/3030/4	31	31	72	LN	1		
	5990/2540/3	26	41	77	LP	1		
	5990/2540/4	26	41	77	LN	1		
	5990/3035/3	31	36	77	LP	1		
	5990/3035/4	31	36	77	LN	1		
	5990/2545/3	26	46	82	LP	1		
	5990/2545/4	26	46	82	LN	1		
	5990/3040/3	31	41	82	LP	1		
	5990/3040/4	31	41	82	LN	1		
	5990/3535/3	36	36	82	LP	1		
	5990/3535/4	36	36	82	LN	1		
	5990/2550/3	26	51	87	LP	1		
	5990/2550/4	26	51	87	LN	1		
	5990/3540/3	36	41	87	LP	1		
	5990/3540/4	36	41	87	LN	1		
	5990/3045/3	31	46	87	LP	1		
	5990/3045/4	31	46	87	LN	1		
	5990/2555/3	26	56	92	LP	1		
	5990/2555/4	26	56	92	LN	1		
	5990/3050/3	31	51	92	LP	1		
	5990/3050/4	31	51	92	LN	1		
	5990/3545/3	36	46	92	LP	1		
	5990/3545/4	36	46	92	LN	1		
	5990/4040/3	41	41	92	LP	1		
	5990/4040/4	41	41	92	LN	1		
	5990/2560/3	26	61	97	LP	1		
	5990/2560/4	26	61	97	LN	1		
	5990/3055/3	31	56	97	LP	1		
	5990/3055/4	31	56	97	LN	1		
	5990/2565/3	26	66	102	LP	1		
	5990/2565/4	26	66	102	LN	1		

DESCRIPCIÓN	REF.	MEDIDAS			ACABADOS	UDS  	PRECIO	
		A	B	C			COMPLETA	S/CILINDRO
5990/3060/3	31	61	102	LP	1			
5990/3060/4	31	61	102	LN	1			
5990/3555/3	36	56	102	LP	1			
5990/3555/4	36	56	102	LN	1			
5990/4050/3	41	51	102	LP	1			
5990/4050/4	41	51	102	LN	1			
5990/4545/3	46	46	102	LP	1			
5990/4545/4	46	46	102	LN	1			
5990/4055/3	41	56	107	LP	1			
5990/4055/4	41	56	107	LN	1			
5990/2575/3	26	76	112	LP	1			
5990/2575/4	26	76	112	LN	1			
5990/3565/3	36	66	112	LP	1			
5990/3565/4	36	66	112	LN	1			
5990/4060/3	41	61	112	LP	1			
5990/4060/4	41	61	112	LN	1			
5990/4555/3	46	56	112	LP	1			
5990/4555/4	46	56	112	LN	1			
5990/5050/3	51	51	112	LP	1			
5990/5050/4	51	51	112	LN	1			
5990/2585/3	26	86	122	LP	1			
5990/2585/4	26	86	122	LN	1			
5990/3080/3	31	81	122	LP	1			
5990/3080/4	31	81	122	LN	1			
5990/3575/3	36	76	122	LP	1			
5990/3575/4	36	76	122	LN	1			
5990/4070/3	41	71	122	LP	1			
5990/4070/4	41	71	122	LN	1			
5990/5555/3	56	56	122	LP	1			
5990/5555/4	56	56	122	LN	1			
5990/2595/3	26	96	132	LP	1			
5990/2595/4	26	96	132	LN	1			
5990/4080/3	41	81	132	LP	1			
5990/4080/4	41	81	132	LN	1			
5990/6060/3	61	61	132	LP	1			
5990/6060/4	61	61	132	LN	1			
5990/3595/3	36	96	142	LP	1			
5990/3595/4	36	96	142	LN	1			
5990/6565/3	66	66	142	LP	1			
5990/6565/4	66	66	142	LN	1			
5990/7070/3	71	71	152	LP	1			
5990/7070/4	71	71	152	LN	1			
5990/7575/3	76	76	162	LP	1			
5990/7575/4	76	76	162	LN	1			

DESCRIPCIÓN

REF.

MEDIDAS

ACABADOS



PRECIO  
COMPLETA S/CILINDRO

A B C

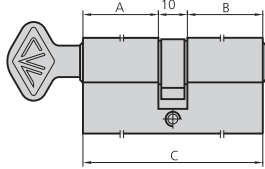

- Cilindro con pomo

5990P2525/3	26	26	62	LP	1		
5990P2525/4	26	26	62	LN	1		
5990P2530/3	26	31	67	LP	1		
5990P2530/4	26	31	67	LN	1		
5990P2535/3	26	36	72	LP	1		
5990P2535/4	26	36	72	LN	1		
5990P3030/3	31	31	72	LP	1		
5990P3030/4	31	31	72	LN	1		
5990P3525/3	36	26	72	LP	1		
5990P3525/4	36	26	72	LN	1		
5990P2540/3	26	41	77	LP	1		
5990P2540/4	26	41	77	LN	1		
5990P2545/3	26	46	82	LP	1		
5990P2545/4	26	46	82	LN	1		
5990P3535/3	36	36	82	LP	1		
5990P3535/4	36	36	82	LN	1		
5990P2550/3	26	51	87	LP	1		
5990P2550/4	26	51	87	LN	1		
5990P3045/3	31	46	87	LP	1		
5990P3045/4	31	46	87	LN	1		
5990P3540/3	36	41	87	LP	1		
5990P3540/4	36	41	87	LN	1		
5990P2555/3	26	56	92	LP	1		
5990P2555/4	26	56	92	LN	1		
5990P3545/3	36	46	92	LP	1		
5990P3545/4	36	46	92	LN	1		
5990P2560/3	26	61	97	LP	1		
5990P2560/4	26	61	97	LN	1		
5990P2565/3	26	66	102	LP	1		
5990P2565/4	26	66	102	LN	1		

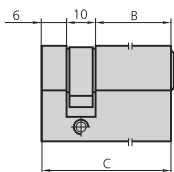

- Medio cilindro

5990T40/3		26	42	LP	1		
5990T40/4		26	42	LN	1		
5990T45/3		31	47	LP	1		
5990T45/4		31	47	LN	1		
5990T50/3		36	52	LP	1		
5990T50/4		36	52	LN	1		
5990T55/3		41	57	LP	1		
5990T55/4		41	57	LN	1		
5990T60/3		46	62	LP	1		
5990T60/4		46	62	LN	1		
5990T65/3		51	67	LP	1		
5990T65/4		51	67	LN	1		
5990T70/3		56	72	LP	1		
5990T70/4		56	72	LN	1		

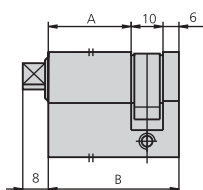

- Medio cilindro
- Triángulo por un lado y ciego por el otro

5990PT2505/3	26	42	LP	1		
5990PT2505/4	26	42	LN	1		

**CILINDRO EUROPERFIL NORMAL LEVA CORTA**
**SERIE 5990P, 5990T, 5990PT**

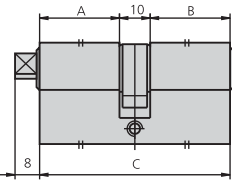
DESCRIPCIÓN	REF.	MEDIDAS			ACABADOS	UDS	PRECIO	
		A	B	C			COMPLETA	S/CILINDRO
 <ul style="list-style-type: none"> <li>• Doble cilindro</li> <li>• Llave por un lado y triángulo por el otro</li> </ul>	5990PT2525/3	26	26	62	LP	1		
	5990PT2525/4	26	26	62	LN	1		
	5990PT2535/3	26	36	72	LP	1		
	5990PT2535/4	26	36	72	LN	1		
	5990PT2545/3	26	46	82	LP	1		
	5990PT2545/4	26	46	82	LN	1		

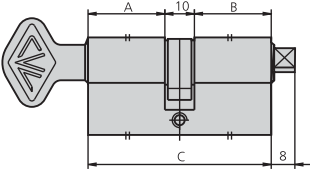
 <ul style="list-style-type: none"> <li>• Doble cilindro</li> <li>• Triángulo por un lado y pomo por el otro</li> </ul>	5990P25T25/3	26	26	62	LP	1		
	5990P25T25/4	26	26	62	LN	1		
	5990P30T30/3	31	31	72	LP	1		
	5990P30T30/4	31	31	72	LN	1		
	5990P35T25/3	36	26	72	LP	1		
	5990P35T25/4	36	26	72	LN	1		
	5990P35T35/3	36	36	82	LP	1		
	5990P35T35/4	36	36	82	LN	1		
	5990P30T45/3	31	46	87	LP	1		
	5990P30T45/4	31	46	87	LN	1		

CARACTERÍSTICAS



ACCESORIOS OPCIONALES

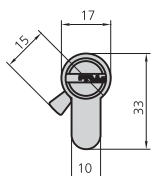

- Cuerpo de latón
- Rotores de latón
- Leva larga de 15mm
- Pasadores antitaladro
- 5 pitones de inoxidable
- 5 llaves



DESCRIPCIÓN	REF.	MEDIDAS			ACABADOS	UDS	PRECIO	
		A	B	C			COMPLETA	S/CILINDRO
<ul style="list-style-type: none"> <li>• Cilindro doble</li> </ul>	6982/2525/3	26	26	62	LP	1		
	6982/2525/4	26	26	62	LN	1		
	6982/2530/3	26	31	67	LP	1		
	6982/2530/4	26	31	67	LN	1		
	6982/2535/3	26	36	72	LP	1		
	6982/2535/4	26	36	72	LN	1		
	6982/3030/3	31	31	72	LP	1		
	6982/3030/4	31	31	72	LN	1		
	6982/2540/3	26	41	77	LP	1		
	6982/2540/4	26	41	77	LN	1		
	6982/3035/3	31	36	77	LP	1		
	6982/3035/4	31	36	77	LN	1		
	6982/2545/3	26	46	82	LP	1		
	6982/2545/4	26	46	82	LN	1		
	6982/3040/3	31	41	82	LP	1		
	6982/3040/4	31	41	82	LN	1		
	6982/3535/3	36	36	82	LP	1		
	6982/3535/4	36	36	82	LN	1		
	6982/2550/3	26	51	87	LP	1		
	6982/2550/4	26	51	87	LN	1		
6982/3540/3	36	41	87	LP	1			
6982/3540/4	36	41	87	LN	1			
6982/3045/3	31	46	87	LP	1			
6982/3045/4	31	46	87	LN	1			
6982/2555/3	26	56	92	LP	1			
6982/2555/4	26	56	92	LN	1			
6982/3050/3	31	51	92	LP	1			
6982/3050/4	31	51	92	LN	1			
6982/3545/3	36	46	92	LP	1			
6982/3545/4	36	46	92	LN	1			
6982/4040/3	41	41	92	LP	1			
6982/4040/4	41	41	92	LN	1			
6982/2560/3	26	61	97	LP	1			
6982/2560/4	26	61	97	LN	1			
6982/3055/3	31	56	97	LP	1			
6982/3055/4	31	56	97	LN	1			
6982/4045/3	41	46	97	LP	1			
6982/4045/4	41	46	97	LN	1			

DESCRIPCIÓN	REF.	MEDIDAS			ACABADOS	UDS  	PRECIO	
		A	B	C			COMPLETA	S/CILINDRO
6982/2565/3	26	66	102	LP	1			
6982/2565/4	26	66	102	LN	1			
6982/3060/3	31	61	102	LP	1			
6982/3060/4	31	61	102	LN	1			
6982/3555/3	36	56	102	LP	1			
6982/3555/4	36	56	102	LN	1			
6982/4050/3	41	51	102	LP	1			
6982/4050/4	41	51	102	LN	1			
6982/4545/3	46	46	102	LP	1			
6982/4545/4	46	46	102	LN	1			
6982/4055/3	41	56	107	LP	1			
6982/4055/4	41	56	107	LN	1			
6982/2575/3	26	76	112	LP	1			
6982/2575/4	26	76	112	LN	1			
6982/3565/3	36	66	112	LP	1			
6982/3565/4	36	66	112	LN	1			
6982/4555/3	46	56	112	LP	1			
6982/4555/4	46	56	112	LN	1			
6982/5050/3	51	51	112	LP	1			
6982/5050/4	51	51	112	LN	1			
6982/4560/3	46	61	117	LP	1			
6982/4560/4	46	61	117	LN	1			
6982/2585/3	26	86	122	LP	1			
6982/2585/4	26	86	122	LN	1			
6982/5555/3	56	56	122	LP	1			
6982/5555/4	56	56	122	LN	1			
6982/2595/3	26	96	132	LP	1			
6982/2595/4	26	96	132	LN	1			
6982/6565/3	66	66	142	LP	1			
6982/6565/4	66	66	142	LN	1			
6982/7070/3	71	71	152	LP	1			
6982/7070/4	71	71	152	LN	1			
6982/7575/3	76	76	162	LP	1			
6982/7575/4	76	76	162	LN	1			

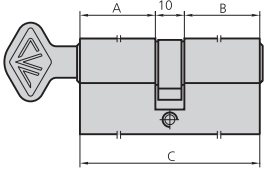
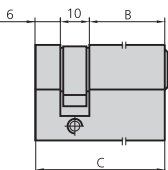

DESCRIPCIÓN	REF.	MEDIDAS			ACABADOS	UDS 	PRECIO	
		A	B	C			COMPLETA	S/CILINDRO
 <ul style="list-style-type: none"> <li>• Cilindro con pomo</li> </ul>	6982P2525/3	26	26	62	LP	1		
	6982P2525/4	26	26	62	LN	1		
	6982P2535/3	26	36	72	LP	1		
	6982P2535/4	26	36	72	LN	1		
	6982P3525/3	36	26	72	LP	1		
	6982P3525/4	36	26	72	LN	1		
	6982P3030/3	31	31	72	LP	1		
	6982P3030/4	31	31	72	LN	1		
	6982P2545/3	26	46	82	LP	1		
	6982P2545/4	26	46	82	LN	1		
	6982P3535/3	36	36	82	LP	1		
	6982P3535/4	36	36	82	LN	1		
	6982P4525/3	46	26	82	LP	1		
	6982P4525/4	46	26	82	LN	1		
	6982P2555/3	26	56	92	LP	1		
	6982P2555/4	26	56	92	LN	1		
	6982P3545/3	36	46	92	LP	1		
	6982P3545/4	36	46	92	LN	1		
	6982P3555/3	36	56	102	LP	1		
	6982P3555/4	36	56	102	LN	1		
6982P3565/3	36	66	112	LP	1			
6982P3565/4	36	66	112	LN	1			
 <ul style="list-style-type: none"> <li>• Medio cilindro</li> </ul>	6982T40/3		26	42	LP	1		
	6982T40/4		26	42	LN	1		
	6982T50/3		36	52	LP	1		
	6982T50/4		36	52	LN	1		
	6982T60/3		46	62	LP	1		
	6982T60/4		46	62	LN	1		
	6982T70/3		56	72	LP	1		
	6982T70/4		56	72	LN	1		





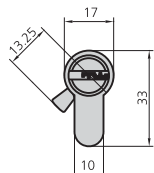

**CARACTERÍSTICAS**

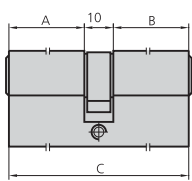
- Cuerpo de latón
- Rotores de latón
- Leva corta de 13,25mm
- Pasadores antitaladro
- 5 pitones de inoxidable
- 5 llaves

**ACCESORIOS OPCIONALES**

DESCRIPCIÓN	REF.	MEDIDAS			ACABADOS	UDS  	PRECIO	
		A	B	C			COMPLETA	S/CILINDRO
 <ul style="list-style-type: none"> <li>• Cilindro doble</li> </ul>	6990/2525/3	26	26	62	LP	1		
	6990/2525/4	26	26	62	LN	1		
	6990/2530/3	26	31	67	LP	1		
	6990/2530/4	26	31	67	LN	1		
	6990/2535/3	26	36	72	LP	1		
	6990/2535/4	26	36	72	LN	1		
	6990/3030/3	31	31	72	LP	1		
	6990/3030/4	31	31	72	LN	1		
	6990/2540/3	26	41	77	LP	1		
	6990/2540/4	26	41	77	LN	1		
	6990/3035/3	31	36	77	LP	1		
	6990/3035/4	31	36	77	LN	1		
	6990/2545/3	26	46	82	LP	1		
	6990/2545/4	26	46	82	LN	1		
	6990/3040/3	31	41	82	LP	1		
	6990/3040/4	31	41	82	LN	1		
	6990/3535/3	36	36	82	LP	1		
	6990/3535/4	36	36	82	LN	1		
	6990/2550/3	26	51	87	LP	1		
	6990/2550/4	26	51	87	LN	1		
	6990/3540/3	36	41	87	LP	1		
	6990/3540/4	36	41	87	LN	1		
	6990/3045/3	31	46	87	LP	1		
	6990/3045/4	31	46	87	LN	1		
	6990/2555/3	26	56	92	LP	1		
	6990/2555/4	26	56	92	LN	1		
	6990/3050/3	31	51	92	LP	1		
	6990/3050/4	31	51	92	LN	1		
6990/3545/3	36	46	92	LP	1			
6990/3545/4	36	46	92	LN	1			
6990/4040/3	41	41	92	LP	1			
6990/4040/4	41	41	92	LN	1			
6990/2560/3	26	61	97	LP	1			
6990/2560/4	26	61	97	LN	1			
6990/3055/3	31	56	97	LP	1			
6990/3055/4	31	56	97	LN	1			
6990/4045/3	41	46	97	LP	1			
6990/4045/4	41	46	97	LN	1			

DESCRIPCIÓN	REF.	MEDIDAS			ACABADOS	UDS  	PRECIO	
		A	B	C			COMPLETA	S/CILINDRO
6990/2565/3	26	66	102	LP	1			
6990/2565/4	26	66	102	LN	1			
6990/3060/3	31	61	102	LP	1			
6990/3060/4	31	61	102	LN	1			
6990/3555/3	36	56	102	LP	1			
6990/3555/4	36	56	102	LN	1			
6990/4050/3	41	51	102	LP	1			
6990/4050/4	41	51	102	LN	1			
6990/4545/3	46	46	102	LP	1			
6990/4545/4	46	46	102	LN	1			
6990/4055/3	41	56	107	LP	1			
6990/4055/4	41	56	107	LN	1			
6990/2575/3	26	76	112	LP	1			
6990/2575/4	26	76	112	LN	1			
6990/3565/3	36	66	112	LP	1			
6990/3565/4	36	66	112	LN	1			
6990/4555/3	46	56	112	LP	1			
6990/4555/4	46	56	112	LN	1			
6990/5050/3	51	51	112	LP	1			
6990/5050/4	51	51	112	LN	1			
6990/4560/3	46	61	117	LP	1			
6990/4560/4	46	61	117	LN	1			
6990/2585/3	26	86	122	LP	1			
6990/2585/4	26	86	122	LN	1			
6990/5555/3	56	56	122	LP	1			
6990/5555/4	56	56	122	LN	1			
6990/2595/3	26	96	132	LP	1			
6990/2595/4	26	96	132	LN	1			
6990/6565/3	66	66	142	LP	1			
6990/6565/4	66	66	142	LN	1			
6990/7070/3	71	71	152	LP	1			
6990/7070/4	71	71	152	LN	1			
6990/7575/3	76	76	162	LP	1			
6990/7575/4	76	76	162	LN	1			

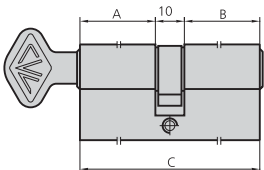
DESCRIPCIÓN	REF.	MEDIDAS			ACABADOS	UDS  	PRECIO	
		A	B	C			COMPLETA	S/CILINDRO
 <ul style="list-style-type: none"> <li>• Cilindro con pomo</li> </ul>	6990P2525/3	26	26	62	LP	1		
	6990P2525/4	26	26	62	LN	1		
	6990P2535/3	26	36	72	LP	1		
	6990P2535/4	26	36	72	LN	1		
	6990P3525/3	36	26	72	LP	1		
	6990P3525/4	36	26	72	LN	1		
	6990P3030/3	31	31	72	LP	1		
	6990P3030/4	31	31	72	LN	1		
	6990P2545/3	26	46	82	LP	1		
	6990P2545/4	26	46	82	LN	1		
	6990P3535/3	36	36	82	LP	1		
	6990P3535/4	36	36	82	LN	1		
	6990P4525/3	46	26	82	LP	1		
	6990P4525/4	46	26	82	LN	1		
	6990P2555/3	26	56	92	LP	1		
	6990P2555/4	26	56	92	LN	1		
	6990P3545/3	36	46	92	LP	1		
	6990P3545/4	36	46	92	LN	1		
	6990P3555/3	36	56	102	LP	1		
	6990P3555/4	36	56	102	LN	1		
6990P3565/3	36	66	112	LP	1			
6990P3565/4	36	66	112	LN	1			

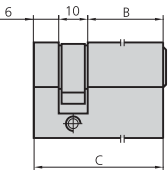
 <ul style="list-style-type: none"> <li>• Medio cilindro</li> </ul>	6990T40/3		26	42	LP	1		
	6990T40/4		26	42	LN	1		
	6990T50/3		36	52	LP	1		
	6990T50/4		36	52	LN	1		
	6990T60/3		46	62	LP	1		
	6990T60/4		46	62	LN	1		
	6990T70/3		56	72	LP	1		
	6990T70/4		56	72	LN	1		

CARACTERÍSTICAS

- Cilindro ovalado pequeño
- Cuerpo de latón
- Rotores de latón
- Dos levas
- 3 llaves

ACCESORIOS OPCIONALES

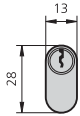

DESCRIPCIÓN	REF.	MEDIDAS			ACABADOS	APLICABLE A CERRADURAS	UDS	PRECIO	
		A	B	C				COMPLETA	S/CILINDRO
<ul style="list-style-type: none"> <li>• Cilindro doble</li> </ul>	5963/2222/3	22	22	54	LP	1963	1		
	5963/2222/4	22	22	54	LN	1963	1		
	5963/2525/3	26	26	62	LP	1963	1		
	5963/2525/4	26	26	62	LN	1963	1		
	5963/3030/3	31	31	72	LP	1963	1		
	5963/3030/4	31	31	72	LN	1963	1		
	5963/3535/3	36	36	82	LP	1963	1		
	5963/3535/4	36	36	82	LN	1963	1		
	5963/4040/3	41	41	92	LP	1963	1		
	5963/4040/4	41	41	92	LN	1963	1		
<ul style="list-style-type: none"> <li>• Medio cilindro</li> </ul>	5963T36/3	22	36		LP	1963	1		
	5963T36/4	22	36		LN	1963	1		

**CARACTERÍSTICAS**

- Cuerpo de latón
- Rotores de latón
- Con levas y vástagos
- 3 llaves

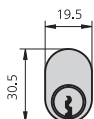
**ACCESORIOS OPCIONALES**

DESCRIPCIÓN	REF.	MEDIDAS			ACABADOS	APLICABLE A CERRADURAS	UDS	PRECIO	
		A	B	C				COMPLETA	S/CILINDRO
<ul style="list-style-type: none"> <li>• Cilindro doble</li> <li>• Ovalado</li> </ul>	5081/3030/3	26,5	26,5	74	LP	1981	1		
	5081/3030/4	26,5	26,5	74	LN		1		
<ul style="list-style-type: none"> <li>• Cilindro doble</li> <li>• Redondo</li> </ul>	5181/3030/3	26,5	26,5	74	LP	11981	1		
	5181/3030/4	26,5	26,5	74	LN		1		



**CARACTERÍSTICAS**

- Cuerpo de latón
- Rotores de latón
- Con levas y vástagos
- 3 llaves

**ACCESORIOS OPCIONALES**

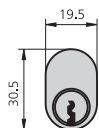

DESCRIPCIÓN	REF.	MEDIDAS			ACABADOS APLICABLE A CERRADURAS	UDS	PRECIO	
		A	B	C			COMPLETA	S/CILINDRO
<ul style="list-style-type: none"> <li>• Cilindro doble</li> <li>• Ovalado</li> </ul>	5961/2525/3	25	25	64	LP	1		
	5961/2525/4	25	25	64	LN	1		
	5961/3030/3	30	30	74	LP	1		
	5961/3030/4	30	30	74	LN	1		

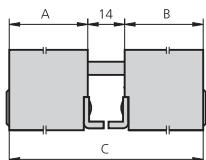



**CARACTERÍSTICAS**

- Cuerpo de latón
- Rotores de latón
- Con levas y vástagos
- 3 llaves

**ACCESORIOS OPCIONALES**

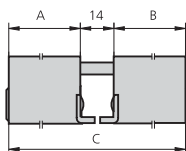
DESCRIPCIÓN	REF.	MEDIDAS			ACABADOS APLICABLE A CERRADURAS	UDS	PRECIO	
		A	B	C			COMPLETA	S/CILINDRO



- Cilindro doble
- Redondo

5962/2525/3	25	25	64	LP	1962	1		
5962/3030/3	30	30	74	LN	1962	1		
5962/4040/3	40	40	94	LP	1962	1		

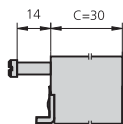

- Medio cilindro
- Redondo

5962T30/3			30	LP	1962	1		
5962T40/3			40	LN	1962	1		

CARACTERÍSTICAS

- Cilindro ovalado
- Cuerpo de latón
- Rotores de latón
- Con levas y vástagos
- 3 llaves

ACCESORIOS OPCIONALES

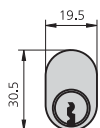

DESCRIPCIÓN	REF.	MEDIDAS			ACABADOS APLICABLE A CERRADURAS	UDS	PRECIO		
		A	B	C			COMPLETA	S/CILINDRO	
<ul style="list-style-type: none"> <li>• Cilindro doble</li> <li>• Llave normal</li> </ul>	5964/2525/3	25	25	66	LP	1			
	5964/2525/4	25	25	66	LN	1			
	5964/3030/3	30	30	76	LP	1			
	5964/3030/4	30	30	76	LN	1964	1		
	5964/4040/3	40	40	96	LP	1			
	5964/4040/4	40	40	96	LN	1			
<ul style="list-style-type: none"> <li>• Cilindro doble con pomo</li> <li>• Llave normal</li> </ul>	5964P3030/3	30	30	76	LP	1964	1		
	5964P3030/4	30	30	76	LN	1			
<ul style="list-style-type: none"> <li>• Medio cilindro</li> <li>• Llave normal</li> </ul>	5964T25/3			25	LP	1964	1		
	5964T25/4			25	LN	1			
	5964T30/3			30	LP	1			
	5964T30/4			30	LN	1964	1		
	5964T40/3			40	LP	1			
	5964T40/4			40	LN	1			
<ul style="list-style-type: none"> <li>• Cilindro doble</li> <li>• Llave de seguridad</li> </ul>	6964/3030/3	30	30	76	LP	1964	1		
	6964/3030/4	30	30	76	LN	1			
<ul style="list-style-type: none"> <li>• Medio cilindro</li> <li>• Llave de seguridad</li> </ul>	6964T30/3			30	LP	1964	1		
	6964T30/4			30	LN	1			



**CARACTERÍSTICAS**

- Cilindro ovalado
  - Cuerpo de latón
  - Rotores de latón
  - Con levas y vástagos
- 
- 3 llaves

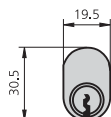
**ACCESORIOS OPCIONALES**

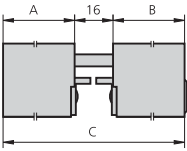
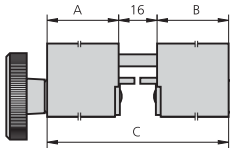
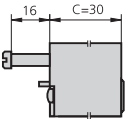
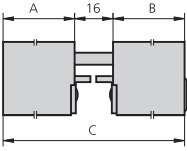
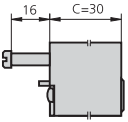
DESCRIPCIÓN	REF.	MEDIDAS			ACABADOS APLICABLE A CERRADURAS	UDS	PRECIO	
		A	B	C			COMPLETA	S/CILINDRO
 <ul style="list-style-type: none"> <li>• Cilindro doble</li> <li>• Llave normal</li> </ul>	5968/2525/3	25	25	66	LP	1		
	5968/2525/4	25	25	66	LN	1		
	5968/3030/3	30	30	76	LP	1		
	5968/3030/4	30	30	76	LN	1		
	5968/4040/3	40	40	96	LP	1		
	5968/4040/4	40	40	96	LN	1		
 <ul style="list-style-type: none"> <li>• Cilindro doble con pomo</li> <li>• Llave normal</li> </ul>	5968P3030/3	30	30	76	LP	1		
	5968P3030/4	30	30	76	LN	1		
 <ul style="list-style-type: none"> <li>• Medio cilindro</li> <li>• Llave normal</li> </ul>	5968T25/3			25	LP	1		
	5968T25/4			25	LN	1		
	5968T30/3			30	LP	1		
	5968T30/4			30	LN	1		
	5968T40/3			40	LP	1		
5968T40/4			40	LN	1			
 <ul style="list-style-type: none"> <li>• Cilindro doble</li> <li>• Llave de seguridad</li> </ul>	6968/3030/3	30	30	76	LP	1		
	6968/3030/4	30	30	76	LN	1		
 <ul style="list-style-type: none"> <li>• Medio cilindro</li> <li>• Llave de seguridad</li> </ul>	6968T30/3			30	LP	1		
	6968T30/4			30	LN	1		

CARACTERÍSTICAS

- Cilindro ovalado
- Cuerpo de latón
- Rotores de latón
- Con levas y vástagos
- 3 llaves

ACCESORIOS OPCIONALES

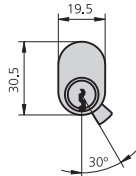

DESCRIPCIÓN	REF.	MEDIDAS			ACABADOS	APLICABLE A	UDS	PRECIO	
		A	B	C				CERRADURAS	COMPLETA S/CILINDRO
<ul style="list-style-type: none"> <li>• Cilindro doble</li> </ul>	5979/3030/3	30	30	76	LP	1979	1		
	5979/3030/4	30	30	76	LN		1		
<ul style="list-style-type: none"> <li>• Cilindro doble con pomo</li> </ul>	5979P3030/3	30	30	76	LP	1979P	1		
	5979P3030/4	30	30	76	LN		1		

## VÍAS DE ESCAPE Y CORTAFUEGO

Barra Antipánico de Cierre Lateral con Marcado CE	151
• Serie 5000	151
Barra Antipánico acoplable a cerradura de embutir con Marcado CE	152
• Serie 5500	152
Barra Antipánico de cierre alto-bajo con Marcado CE	153
• Serie 6000	153
Cerradura con certificado EN12209	154
• Serie 400	154
Cerradura Cortafuego y Antipánico con Marcado CE	156
• Serie 410	156
Cerradura Antipánico	159
• Serie 3000	159
Cerraduras Electromagnéticas	161
Accesorios	162
• Escudos, Manillas y Pomos de Acero Inoxidable	162
• Escudos y Manillas en negro	164
• Cilindros y otros accesorios	165

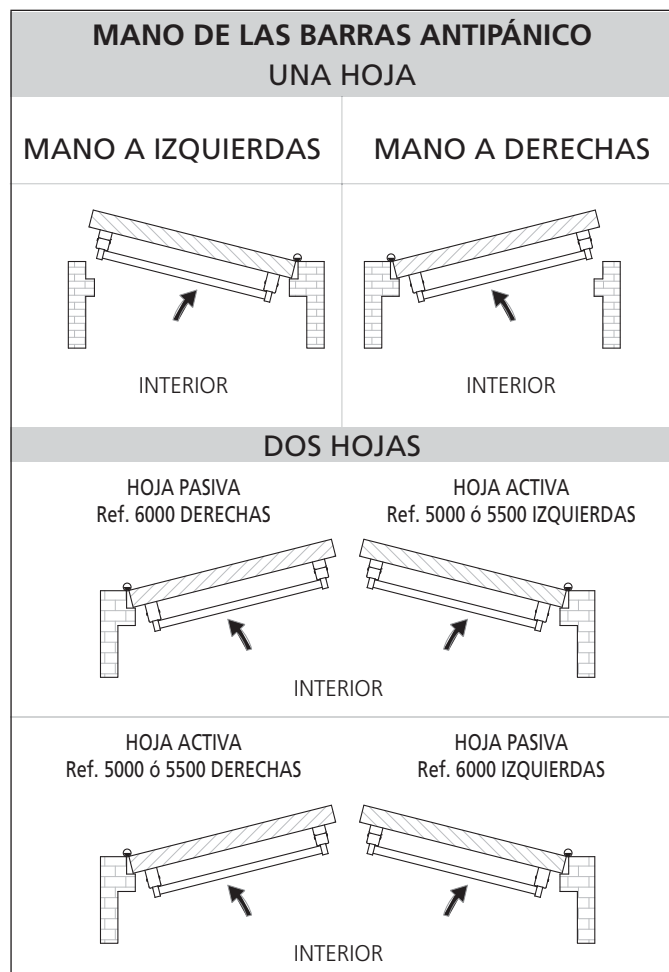
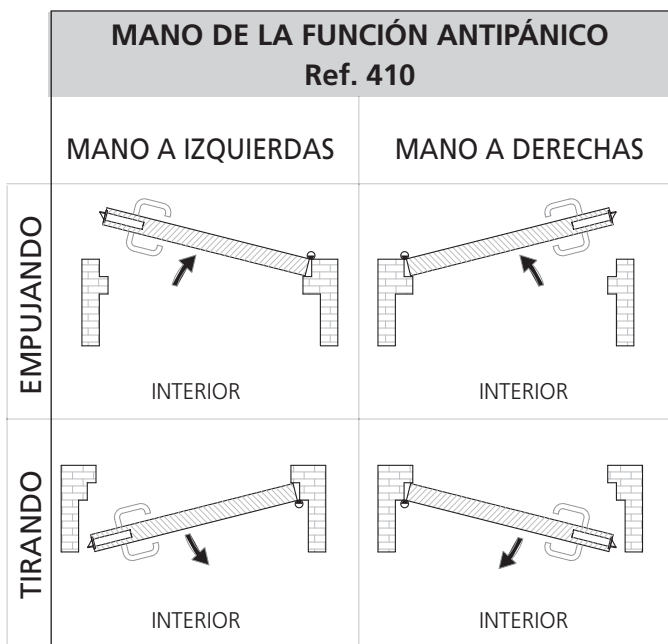

**BARRA ANTIPÁNICO DE CIERRE LATERAL CON MARCADO CE**
**SERIE 5000**
**CARACTERÍSTICAS**

- 1 punto de cierre lateral
- Solución reversible
- Mecanismo de condensa y manilla posibilitando la colocación opcional de accionamiento exterior
- Cerradero CE5000
- Certificado según norma europea UNE-EN 1125

3	7	6	B	1	4	2	2	A	B
---	---	---	---	---	---	---	---	---	---

**ACCESORIOS OPCIONALES**

- Barra de apoyo de medidas especiales
- Manilla y escudo en negro M5000, M5001, M5002, M5003.
- Manilla y escudo de acero inoxidable CM5006, CM5007, CM5008, CM5009 para distintos entre ejes
- Pomo y escudo en acero inoxidable CM5005 para distintos entre ejes
- Cilindro B5000



ANTIPÁNICO INOX



ANTIPÁNICO NIQUEL MATE



ANTIPÁNICO NEGRO

**DESCRIPCIÓN**
**REF.**
**ACABADOS**
**UDS**
**PRECIO**
**SOPORTE**
**BARRA**

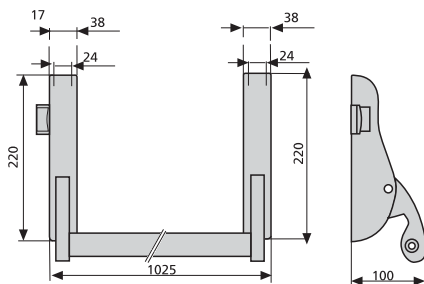
**COMPLETA S/CILINDRO**

5000/1N	Pintado negro	Pintado rojo	1	5		
5000/1NM	Niquel mate	Acero inoxidable Aisi 304L	1	5		
5000/6	Acero inoxidable Aisi 304L	Acero inoxidable Aisi 304L	1	5		

# BARRA ANTIPÁNICO ACOPLABLE A CERRADURA DE EMBUTIR CON MARCADO CE

# SERIE 5500



ANTIPÁNICO INOX



ANTIPÁNICO NIQUEL MATE



ANTIPÁNICO NEGRO

## CARACTERÍSTICAS

- Acoplable a cerradura de embutir
- Solución reversible
- Certificado según norma europea UNE-EN 1125

3 7 6 B 1 4 2 2 A A

## ACCESORIOS OPCIONALES

- Cerradura antipánico serie 410LT y 410T, 3005
- Barra de apoyo de medidas especiales
- Manilla y escudo de acero inoxidable CM5006, CM5007, CM5008, CM5009 para distintos entre ejes
- Pomo y escudo en acero inoxidable CM5005 para distintos entre ejes



## DESCRIPCIÓN

## REF.

## ACABADOS

## UDS

## PRECIO

### SOPORTE

### BARRA



### COMPLETA S/CILINDRO

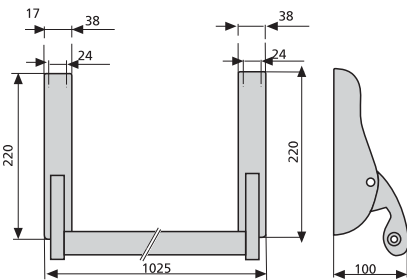

5500/1N	Pintado negro	Pintado rojo	1	5		
5500/1NM	Niquel mate	Acero inoxidable Aisi 304L	1	5		
5500/6	Acero inoxidable Aisi 304L	Acero inoxidable Aisi 304L	1	5		
5500/6E	Acero inoxidable Aisi 316	Acero inoxidable Aisi 316	1	5		

## CERRADURAS CORTAFUEGO



3005 + manilla  
(ver pág. 159)



400T + tirador  
(ver pág. 155)



400LT + tirador  
(ver pág. 155)

# BARRA ANTIPÁNICO DE CIERRE ALTO-BAJO CON MARCADO CE

# SERIE 6000

## CARACTERÍSTICAS

- 2 puntos de cierre alto-bajo
- Reversible sin accionamiento exterior
- Cerradores CER5000 y CEB6000
- Certificado según norma europea UNE-EN 1125

3 7 6 B 1 4 2 2 A A

## ACCESORIOS OPCIONALES

- Barra de apoyo y fallebas de medidas especiales
- Manilla y escudo en negro M5000, M5001 y M5003
- Manilla y escudo de acero inoxidable CM5006, CM5007, CM5009 para distintos entre ejes
- Pomo y escudo en acero inoxidable CM5005 para distintos entre ejes
- Cilindro B5000

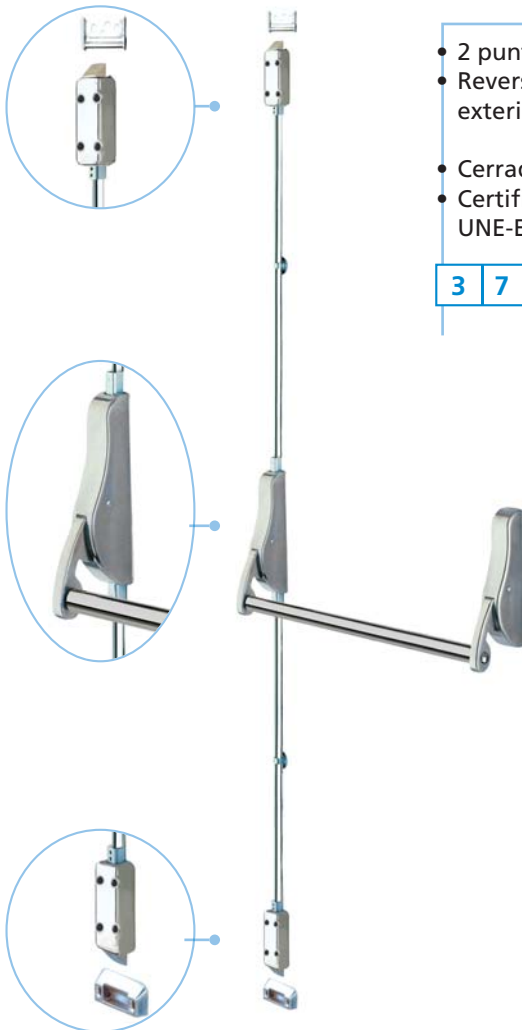

DESCRIPCIÓN	REF.	ACABADOS			UDS		PRECIO	
		SOPORTE	BARRA	FALLEBA			COMPLETA	S/CILINDRO
	6000D/1N	Pintado negro	Pintado rojo	Pintado negro	1	5		
	6000I/1N	Pintado negro	Pintado rojo	Pintado negro	1	5		
	6000D/1NM	Niquel mate	Acero inoxidable Aisi 304L	Acero inoxidable Aisi 304L	1	5		
	6000I/1NM	Niquel mate	Acero inoxidable Aisi 304L	Acero inoxidable Aisi 304L	1	5		
	6000D/6	Acero inoxidable Aisi 304L	Acero inoxidable Aisi 304L	Acero inoxidable Aisi 304L	1	5		
	6000I/6	Acero inoxidable Aisi 304L	Acero inoxidable Aisi 304L	Acero inoxidable Aisi 304L	1	5		

CARACTERÍSTICAS

- Certificado según norma europea EN12209

3 M 8 1 0 F 1 B C 2 0

- Frente en acero inoxidable en canto redondo ó cuadrado
- Caja niquelada
- Palanca de acero
- Cuadrado de 8mm
- Resbalón de hierro
- Tornillo de fijación de cilindro
- Cerradero de acero inoxidable en canto redondo ó cuadrado

ACCESORIOS OPCIONALES

- Amplia gama de cilindros (ver página 127 - 148)
- Posibilidad de microinterruptor

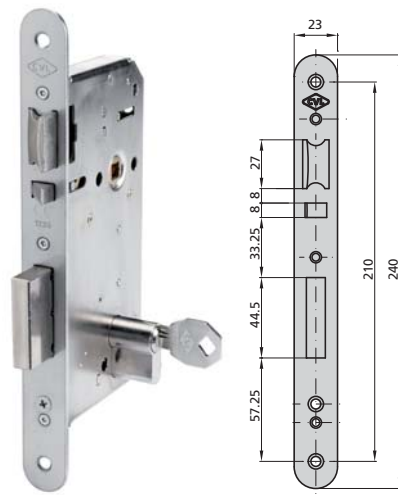

DESCRIPCIÓN

DESCRIPCIÓN	REF.	MEDIDAS		LEVA	ACABADOS		UDS		PRECIO	
		B	A		FRENTE	CANTO			COMPLETA	S/CILINDRO

- Cerradura con picaporte y palanca rectangular de acero
- Cerradura con función antitarjeta

400L60/6HP	60	90	S. CIL	Al	Red	1	12		
401L60/6HP	60	90	S. CIL	Al	Cua	1	12		

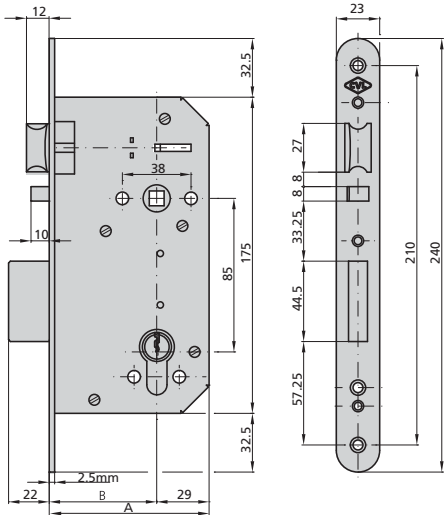

- Cerradura con picaporte y palanca rectangular de acero

400/50/6HP	50	80	S. CIL	Al	Red	1	12		
401/50/6HP	50	80	S. CIL	Al	Cua	1	12		
400/60/6HP	60	90	S. CIL	Al	Red	1	12		
401/60/6HP	60	90	S. CIL	Al	Cua	1	12		

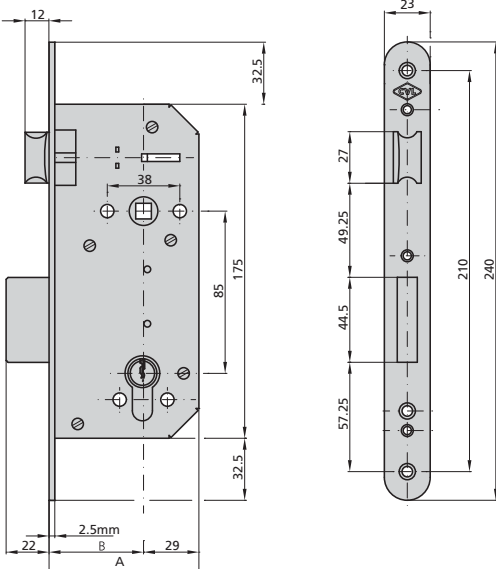



**CERRADURA CON CERTIFICADO EN12209**
**SERIE 400**

DESCRIPCIÓN	REF.	MEDIDAS		LEVA	ACABADOS		UDS		PRECIO	
		B	A		FRENTE	CANTO			COMPLETA	S/CILINDRO
• Cerradura con sólo picaporte de acero	400LT60/6H	60	90	S. CIL	Al	Red	1	12		
• Cerradura con función antitarjeta	401LT60/6H	60	90	S. CIL	Al	Cua	1	12		

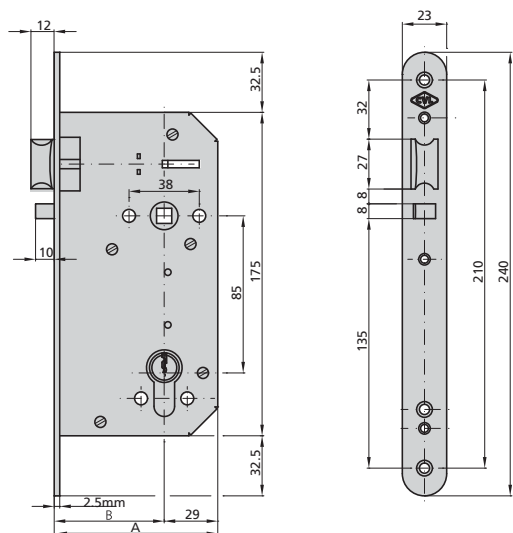

- Cerradura con solo picaporte de acero

400T50/6H	50	80	S. CIL	Al	Red	1	12		
401T50/6H	50	80	S. CIL	Al	Cua	1	12		
400T60/6H	60	90	S. CIL	Al	Red	1	12		
401T60/6H	60	90	S. CIL	Al	Cua	1	12		

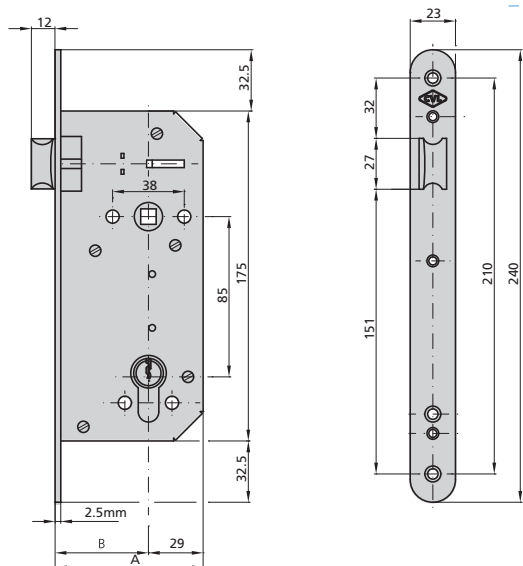



**CARACTERÍSTICAS**

- Cerradura cortafuego con función antipánico
- Certificado según norma europea EN 12209

3 M 8 1 0 F 1 B C 2 0

- Certificado según norma europea EN179

3 7 6 B 1 3 2 2 A B

- Frente de acero inoxidable en canto redondo o cuadrado
- Caja niquelada
- Cuadradillo de 8mm

- Cerradores de acero inoxidable en canto redondo o cuadrado
- Tornillo de fijación de cilindro

**ACCESORIOS OPCIONALES**

- Amplia gama de cilindros (ver página 127 - 148)
- Posibilidad de microinterruptor



**DESCRIPCIÓN**

REF.	MEDIDAS		LEVA	ACABADOS		UDS		PRECIO	
	B	A		FRENTE	CANTO			COMPLETA	S/CILINDRO

- Cerradura con picaporte y palanca rectangular de acero
- Cerradura con función antitarjeta
- Cerradura con función antipánico
- Cerradura con nueca partida

410L60D/6HP	60	90	S. CIL	Al	Red	1	12		
410L60I/6HP	60	90	S. CIL	Al	Red	1	12		
411L60D/6HP	60	90	S. CIL	Al	Cua	1	12		
411L60I/6HP	60	90	S. CIL	Al	Cua	1	12		

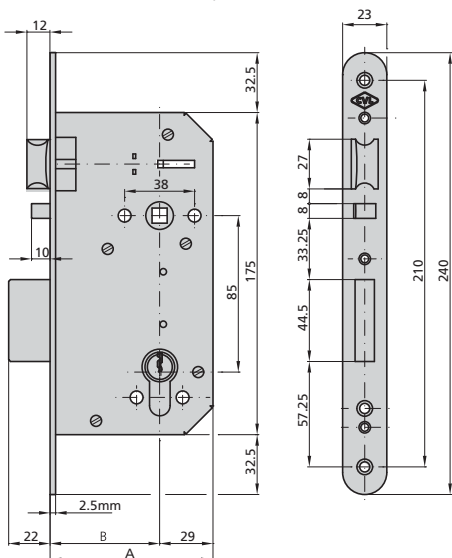

# CERRADURA CORTAFUEGO Y ANTIPÁNICO CON MARCADO CE

# SERIE 410

DESCRIPCIÓN	REF.	MEDIDAS		LEVA	ACABADOS		UDS		PRECIO	
		B	A		FRENTE	CANTO			COMPLETA	S/CILINDRO
<ul style="list-style-type: none"> <li>• Cerradura con picaporte y palanca rectangular de acero</li> <li>• Cerradura con función antipánico</li> <li>• Cerradura con nueca partida</li> </ul>	410/50D/6HP	50	80	S. CIL	Al	Red	1	12		
	410/50I/6HP	50	80	S. CIL	Al	Red	1	12		
	411/50D/6HP	50	80	S. CIL	Al	Cua	1	12		
	411/50I/6HP	50	80	S. CIL	Al	Cua	1	12		
	410/60D/6HP	60	90	S. CIL	Al	Red	1	12		
	410/60I/6HP	60	90	S. CIL	Al	Red	1	12		
	411/60D/6HP	60	90	S. CIL	Al	Cua	1	12		
	411/60I/6HP	60	90	S. CIL	Al	Cua	1	12		

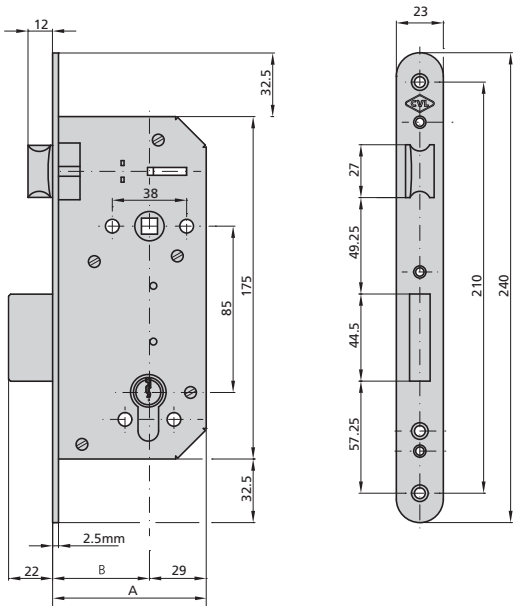

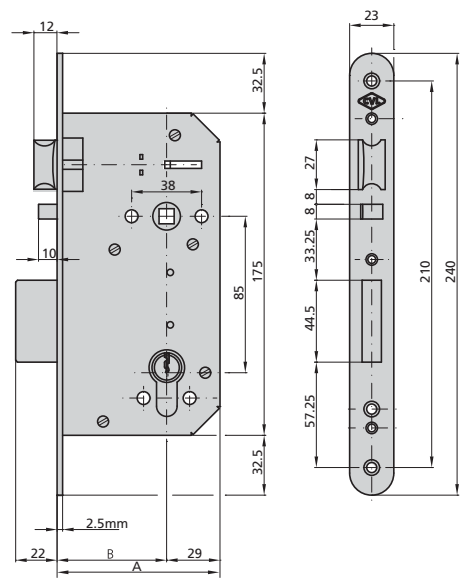

<ul style="list-style-type: none"> <li>• Cerradura con picaporte y palanca rectangular de acero</li> <li>• Cerradura con función antitarjeta</li> <li>• Cerradura con función antipánico</li> <li>• Cerradura con nueca pasante</li> </ul>	410L60/6HP	60	90	S. CIL	Al	Red	1	12		
	411L60/6HP	60	90	S. CIL	Al	Cua	1	12		



# CERRADURA CORTAFUEGO Y ANTIPÁNICO CON MARCADO CE

# SERIE 410

DESCRIPCIÓN	REF.	MEDIDAS		LEVA	ACABADOS		UDS		PRECIO	
		B	A		FRENTE	CANTO			COMPLETA	S/CILINDRO
<ul style="list-style-type: none"> <li>• Cerradura con picaporte y palanca rectangular de acero</li> <li>• Cerradura con función antipánico</li> <li>• Cerradura con nueca pasante</li> </ul>	410/50/6HP	50	80	S. CIL	Al	Red	1	12		
	411/50/6HP	50	80	S. CIL	Al	Cua	1	12		
	410/60/6HP	60	90	S. CIL	Al	Red	1	12		
	411/60/6HP	60	90	S. CIL	Al	Cua	1	12		

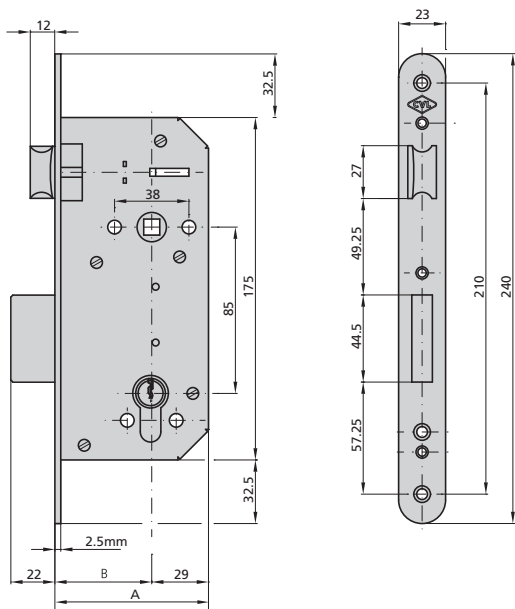

# CERRADURA ANTIPÁNICO

# SERIE 3000

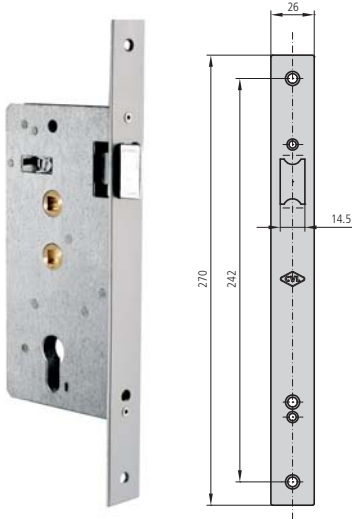

### CARACTERÍSTICAS

- Cerradura antipánico
- Frente en acero
- Cuadradillo de 8mm
- Tornillo de fijación de cilindro
- Cerradero según cerradura
- Cilindro 5982/2535/3

### ACCESORIOS OPCIONALES

DESCRIPCIÓN	REF.	MEDIDAS		LEVA	ACABADOS		UDS		PRECIO	
		B	A		FRENTE	CANTO			COMPLETA	S/CILINDRO

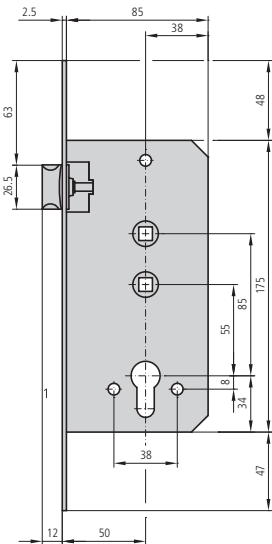

- Accionamiento exterior de manilla condensable mediante cilindro
- Picaporte de acero reversible

3005/6	50	88	15	Al	CL	1	12		
--------	----	----	----	----	----	---	----	--	--

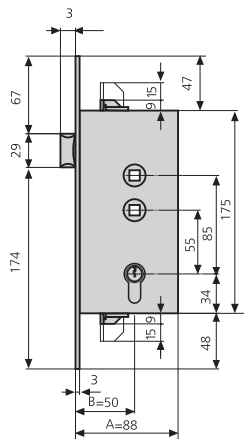



- Accionamiento exterior de manilla condensable mediante cilindro
- 3 puntos de cierre

3000D	50	88	15	HE	CL	1	12		
3000I	50	88	15	HE	CL	1	12		

# CERRADURA ANTIPÁNICO

# SERIE 3000

DESCRIPCIÓN	REF.	MEDIDAS		LEVA	ACABADOS		UDS		PRECIO	
		B	A		FRENTE	CANTO			COMPLETA	S/CILINDRO
<ul style="list-style-type: none"> <li>• Accionamiento exterior de manilla condensable mediante cilindro</li> <li>• 2 puntos de cierre</li> </ul>	3000AD	50	88	15	HE	CL	1	12		
	3000AI	50	88	15	HE	CL	1	12		

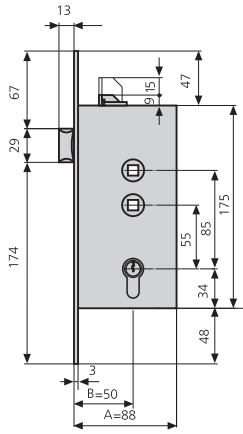



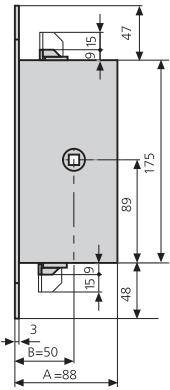







- Accionamiento exterior de manilla condensable mediante cilindro
- 2 puntos de cierre

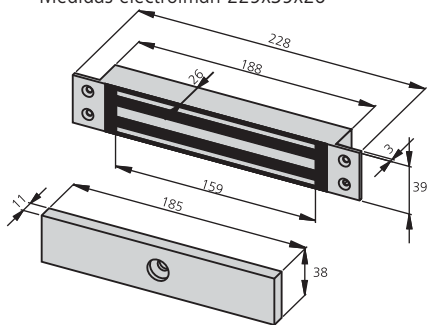

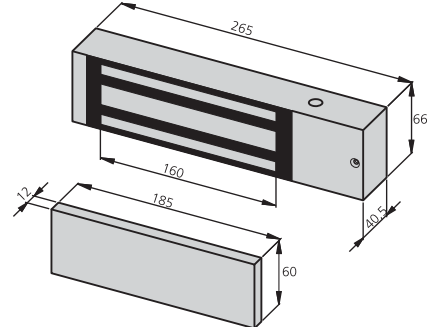
- Cerradura-cremona para hoja pasiva
- 2 puntos de cierre

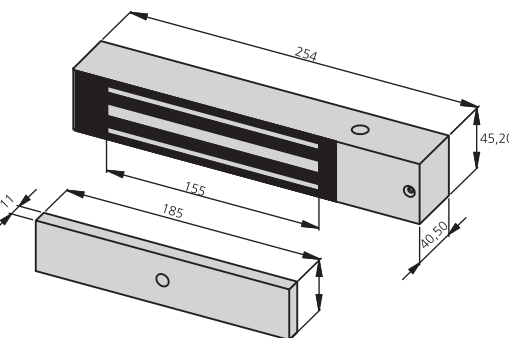
3001	50	88	HE	1	12		
------	----	----	----	---	----	--	--

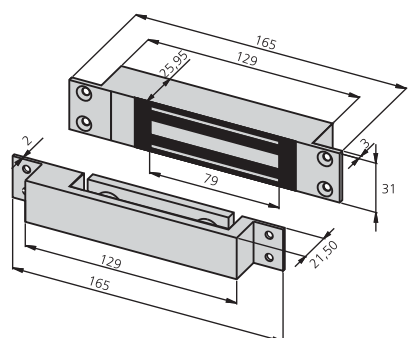
## CERRADURAS ELECTROMAGNÉTICAS

DESCRIPCIÓN	REF.	FUERZA DE RETENCIÓN	UDS  	PRECIO COMPLETA S/CILINDRO
<ul style="list-style-type: none"> <li>Cerradura electromagnética de empotrar</li> <li>Medidas electroimán 229x39x26</li> </ul> 	VENM1	3000N	1	 
<ul style="list-style-type: none"> <li>Cerradura electromagnética de sobreponer</li> <li>Medidas electroimán 248x66x40</li> </ul> 	VENM2	5000N	1	 
<ul style="list-style-type: none"> <li>Cerradura electromagnética de sobreponer</li> <li>Medidas electroimán 220x35x25</li> </ul> 	VENM3	3000N	1	 
<ul style="list-style-type: none"> <li>Cerradura electromagnética de empotrar para puertas de vaivén</li> <li>Medidas electroimán 165x31x26</li> </ul> 	VENM554	7500N	1	 

## ACCESORIOS

# ESCUDOS, MANILLAS Y POMOS DE ACERO INOXIDABLE



### CARACTERÍSTICAS

- Manillas de acero inoxidable certificadas en procedimientos de ensayo de la norma EN 179 de vías de escape por accionamiento de manilla

DESCRIPCIÓN	REF.	ACABADO	CANTO	UDS	PRECIO	
					COMPLETA	S/CILINDRO
<ul style="list-style-type: none"> <li>Escudo con manilla y bocallave cilindro</li> <li>Entre ejes 55mm</li> <li>No incluye cilindro</li> </ul>	CM5006/55/6C	Al	Cua	1		
	CM5006/55/6R	Al	Red	1		
<ul style="list-style-type: none"> <li>Escudo con manilla y bocallave cilindro</li> <li>Entre ejes 72mm</li> <li>No incluye cilindro</li> </ul>	CM5006/72/6C	Al	Cua	1		
	CM5006/72/6R	Al	Red	1		
<ul style="list-style-type: none"> <li>Escudo con manilla y bocallave cilindro</li> <li>Entre ejes 85mm</li> <li>No incluye cilindro</li> </ul>	CM5006/85/6C	Al	Cua	1		
	CM5006/85/6R	Al	Red	1		
<ul style="list-style-type: none"> <li>Escudo con manilla</li> </ul>	CM5007/6C	Al	Cua	1		
	CM5007/6R	Al	Red	1		
<ul style="list-style-type: none"> <li>Escudo con bocallave cilindro</li> <li>Entre ejes 55mm</li> <li>No incluye cilindro</li> </ul>	CM5008/55/6C	Al	Cua	1		
	CM5008/55/6R	Al	Red	1		



**ACCESORIOS**

**ESCUDOS, MANILLAS Y POMOS DE ACERO INOXIDABLE**

DESCRIPCIÓN	REF.	ACABADO	CANTO	UDS	PRECIO	
					COMPLETA	S/CILINDRO

- Escudo con bocallave cilindro
- Entre ejes 72mm
- No incluye cilindro

CM5008/72/6C	Al	Cua	1		
CM5008/72/6R	Al	Red	1		

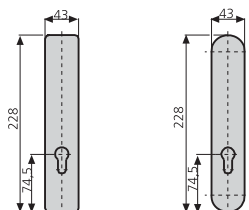

- Escudo con bocallave cilindro
- Entre ejes 85mm
- No incluye cilindro

CM5008/85/6C	Al	Cua	1		
CM5008/85/6R	Al	Red	1		

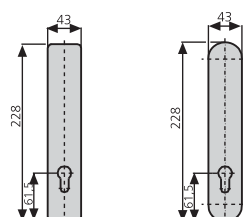

- Escudo ciego

CM5009/6C	Al	Cua	1		
CM5009/6R	Al	Red	1		

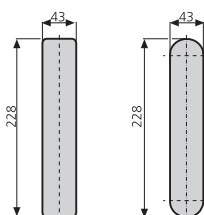

- Escudo con pomo y bocallave cilindro
- Entre ejes 55mm
- No incluye cilindro

CM5005/55/6C	Al	Cua	1		
CM5005/55/6R	Al	Red	1		

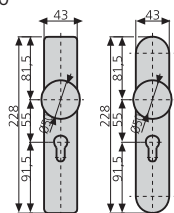

- Escudo con pomo y bocallave cilindro
- Entre ejes 72mm
- No incluye cilindro

CM5005/72/6C	Al	Cua	1		
CM5005/72/6R	Al	Red	1		

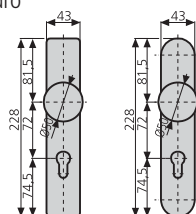

- Escudo con pomo y bocallave cilindro
- Entre ejes 85mm
- No incluye cilindro

CM5005/85/6C	Al	Cua	1		
CM5005/85/6R	Al	Red	1		

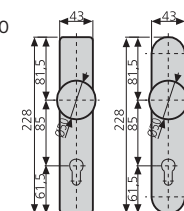

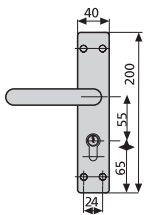
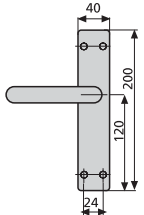
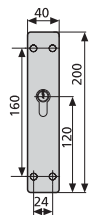
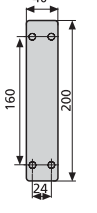
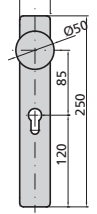
DESCRIPCIÓN	REF.	ACABADO	CANTO	UDS	PRECIO	
					COMPLETA	S/CILINDRO
 <ul style="list-style-type: none"> <li>• Escudo con manilla y bocallave cilindro</li> <li>• Entre ejes 55mm</li> <li>• Incluye cilindro B5000</li> </ul>	M5000/1N	Negro	Cua	1		
 <ul style="list-style-type: none"> <li>• Escudo con manilla</li> </ul>	M5001/1N	Negro	Cua	1		
 <ul style="list-style-type: none"> <li>• Escudo con bocallave cilindro</li> <li>• Entre ejes 55mm</li> <li>• Incluye cilindro B5000</li> </ul>	M5002/1N	Negro	Cua	1		
 <ul style="list-style-type: none"> <li>• Escudo ciego</li> </ul>	M5003/1N	Negro	Cua	1		
 <ul style="list-style-type: none"> <li>• Escudo con tirador y bocallave a 85 mm</li> <li>• Incluye cilindro B5000</li> </ul>	M5004/1N	Negro	Cua	1		

DESCRIPCIÓN	REF.	ACABADO	UDS	PRECIO	
				COMPLETA	S/CILINDRO
• Cilindro para barra antipánico	B5000	CL	1		
	B5000/4	CN	1		

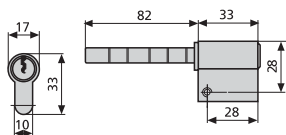

DESCRIPCIÓN	REF.	ACABADO	PRECIO	
			COMPLETA	S/CILINDRO
• Barra de apoyo Ø25*1000 mm	BAR5000/6	AI		
• Barra de apoyo Ø25*1500 mm	BAR5000/6E	AI		
• Barra de apoyo Ø25*1000 mm	BAR5000/1R	HE rojo		
• Barra de apoyo Ø25*1500 mm	BAR5000/1RE	HE rojo		
• Tubo falleba Ø12*1000mm	TUF6000/6	AI		
• Tubo falleba Ø12*1500 mm	TUF6000/6E	AI		
• Tubo falleba Ø12*1000mm	TUF6000/1N	HE negro		
• Tubo falleba Ø12*1500	TUF6000/1NE	HE negro		
• Cerradero lateral	CE5000/1N	HE negro		
• Cerradero lateral	CE5000/6	AI		
• Cerradero bajo	CEB6000/1N	Acero microfundido negro		
• Cerradero bajo	CEB6000	Acero microfundido		
• Microinterruptor para los antipánicos 5000, 5500 y 6000 MICRO	MICRO			
• Microinterruptor para la Serie 400 y 410	MICRO4000L			



## CONTROL DE ACCESOS



Palanca deslizante entre ejes 85 mm  
• Serie ID1 inDeco

168



Kit lector de proximidad MIFARE  
• Control de acceso autónomo

168

169

169



Escudo electrónico de proximidad  
• Control de acceso autónomo

170

170



**Novedad**

**PALANCA DESLIZANTE ENTRE EJES 85 mm.**

**SERIE ID1 inDeco**

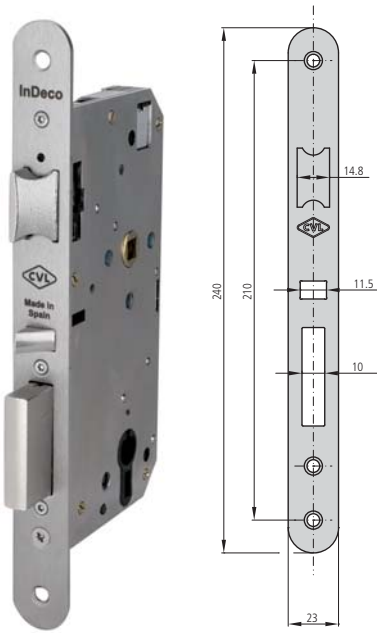

**CARACTERÍSTICAS**

- Cerradura de 1 punto de cierre con frente inox de 23mm en canto redondo
- Picaporte reversible de acero
- Incluye función antitarjeta
- Palanca de acero de 21mm de salida
- Cierre automático de la palanca al cerrar la puerta
- Inteligencia invisible: sistema electromecánico integrado en la cerradura habilitando la manilla exterior mediante un accionamiento eléctrico
- Función antipánico desde el interior
- Función antipánico reversible
- Cerradura preparada para atado normalizado de manillas y rosetas
- Incluye CPU con batería
- Incluye cerradero CEID1/6D y CEID1/6I
- Tornillo de fijación de cilindro
- Componentes de sujeción

**ACCESORIOS OPCIONALES**

- Gama completa de cilindros (ver página 127 - 148)
- Lector de proximidad

DESCRIPCIÓN	REF.	MEDIDAS		LEVA	ACABADOS		UDS	PRECIO	
		B	A		FRENTE	CILINDRO		COMPLETA	S/CILINDRO
<ul style="list-style-type: none"> <li>• Picaporte y palanca</li> <li>• No incluye cilindro</li> </ul>	ID1/60/6	90	60	15	Al		1		

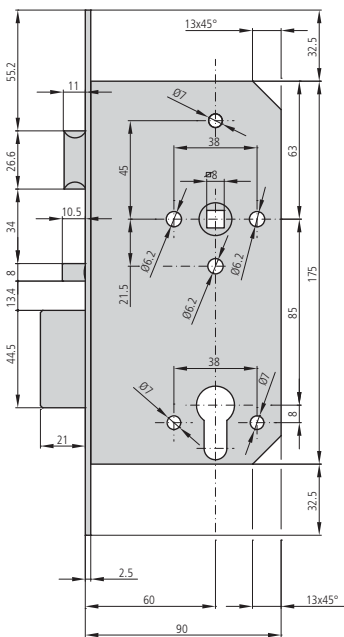

**KIT LECTOR DE PROXIMIDAD MIFARE**

**CONTROL DE ACCESO AUTÓNOMO**

**CARACTERÍSTICAS**

- Kit control de acceso
- Apertura con tarjeta de proximidad
- Listo para utilizar:
  - Tarjetas y lector configurados desde fábrica
  - Sin necesidad de software
- Posibilidades amplias de amaestramiento
- Tecnología Network on Card
- Conectable a cerradura eléctrica DUE, o cerraderos eléctricos
- CPU HS/C
- Tarjetas Mifare configuradas

**ACCESORIOS OPCIONALES**



**DESCRIPCIÓN**

**REF.**

**MEDIDAS**  
B A

**LEVA**

**ACABADOS**  
FRENTE CILINDRO

**UDS**



• Lector de proximidad R/W i/BUTTON

14154000

1



• CPU HS/C NOC

14154000

1



• Tarjeta MIFARE 1K numerada

13718000

1



**Novedad**

**ESCUDO ELECTRÓNICO DE PROXIMIDAD**

**CONTROL DE ACCESO AUTÓNOMO**





**CARACTERÍSTICAS**

- Sistema de control de acceso autónomo con lector integrado
- Apertura con tarjeta de proximidad
- Listo para utilizar:
  - Tarjetas y lector configurados desde fábrica
  - Sin necesidad de software
  - Sin necesidad de cableado (alimentación por pilas)
- Posibilidades amplias de amaestramiento
- Tecnología Network on Card
- Escudo inox de anchura de 30mm adaptable a carpintería de aluminio
- Tarjetas Mifare configuradas

**ACCESORIOS OPCIONALES**

- Cerradura 410 ó 410L

DESCRIPCIÓN	REF.	MEDIDAS B A	LEVA	ACABADOS FRENTE CILINDRO	UDS
<ul style="list-style-type: none"> <li>• Escudo electrónico de proximidad</li> </ul> 	1404X000-Y				1
<ul style="list-style-type: none"> <li>• Tarjeta MIFARE 1K numerada</li> </ul> 	13718000				1



## VARIOS

Otros precios	172
• Seguridad	172
Condiciones de venta	173

**OTROS PRECIOS****LLAVE SERRETA**

DESCRIPCIÓN	PRECIO
Cilindro largo especial	
Maestramiento. 1 lado	
Maestramiento. 2 lados	
Gran Maestra. Un lado	
Gran Maestra. Dos lados	
Cilindro con llaves iguales	
Cilindro con llaves según muestra	
Llave suplementaria (125)	
Llave sin mecanizar (125)	
Llave mecanizada según muestra (125)	
Llave gorja suplementaria (63R)	
Llave gorja (63R)	
Reductor metálico	
Rgo. alargamiento de cilindro (60, 70, 80 mm) cerradura sobreponer	
Rgo. configuración tarjeta Mifare	

**OTROS PRECIOS****SEGURIDAD**

DESCRIPCIÓN	PRECIO
Maestramiento. 1 lado	
Maestramiento. 2 lados	
Llave suplementaria	
Llave sin mecanizar	
Llave mecanizada según muestra	
Cilindro con llaves iguales	
Cilindro con llaves según muestra	

## CONDICIONES DE VENTA

- Giro a 60 días Neto.
  - Giro a 90 días 1% recargo.
  - Los precios de esta tarifa están sujetos al impuesto IVA.
  - Los pedidos superiores a 500 € se pondrán en destino a portes pagados cuando la entrega se realice por las agencias de transporte seleccionadas por C.V.L. (Península, Baleares y Canarias).
  - Los portes serán a cargo del cliente si la agencia de transporte indicada por éste no es una de las seleccionadas por C.V.L.
  - Los pedidos inferiores a 500 € tendrán un recargo de 6,01 € fijos más un 3% en concepto de portes. (Península, Baleares y Canarias).
  - Todo pedido implica la aceptación, sin reservas, de todas las condiciones de venta.
  - Los códigos EAN corresponden siempre a la cerradura estandar completa.
  - La empresa se reserva el derecho a modificar sin previo aviso sus modelos, características y especificaciones.
-



Sistemas Valle Léniz S.L.U. • Pol. Arbi Zelai • Apdo 6, 20550 • Aretxabaleta • Gipuzkoa (Spain)

Tel: 943 79 10 16 • Fax: 943 79 25 46 • E-mail: [cvl@cvl.es](mailto:cvl@cvl.es) • Web: [www.cvl.es](http://www.cvl.es)